



KBox C-103-CFL-4



KBox C-103-CFL-2



KBox C-103-CFL-1



KBox C-103-CFL-0

KBox C-103-CFL-x

User Guide, Rev. 1.4

Doc. ID: 1067-5219

This page has been intentionally left blank

 KBOX C-103-CFL-X - USER GUIDE

Disclaimer

Kontron would like to point out that the information contained in this user guide may be subject to alteration, particularly as a result of the constant upgrading of Kontron products. This document does not entail any guarantee on the part of Kontron with respect to technical processes described in the user guide or any product characteristics set out in the user guide. Kontron assumes no responsibility or liability for the use of the described product(s), conveys no license or title under any patent, copyright or mask work rights to these products and makes no representations or warranties that these products are free from patent, copyright or mask work right infringement unless otherwise specified. Applications that are described in this user guide are for illustration purposes only. Kontron makes no representation or warranty that such application will be suitable for the specified use without further testing or modification. Kontron expressly informs the user that this user guide only contains a general description of processes and instructions which may not be applicable in every individual case. In cases of doubt, please contact Kontron.

This user guide is protected by copyright. All rights are reserved by Kontron. No part of this document may be reproduced, transmitted, transcribed, stored in a retrieval system, or translated into any language or computer language, in any form or by any means (electronic, mechanical, photocopying, recording, or otherwise), without the express written permission of Kontron. Kontron points out that the information contained in this user guide is constantly being updated in line with the technical alterations and improvements made by Kontron to the products and thus this user guide only reflects the technical status of the products by Kontron at the time of publishing.

Brand and product names are trademarks or registered trademarks of their respective owners.

©2021 by Kontron Europe GmbH

Kontron Europe GmbH

Gutenbergstraße 2
85737 Ismaning
Germany
www.kontron.com

High Risk Applications Hazard Notice

THIS DEVICE AND ASSOCIATED SOFTWARE ARE NOT DESIGNED, MANUFACTURED OR INTENDED FOR USE OR RESALE FOR THE OPERATION OF NUCLEAR FACILITIES, THE NAVIGATION, CONTROL OR COMMUNICATION SYSTEMS FOR AIRCRAFT OR OTHER TRANSPORTATION, AIR TRAFFIC CONTROL, LIFE SUPPORT OR LIFE SUSTAINING APPLICATIONS, WEAPONS SYSTEMS, OR ANY OTHER APPLICATION IN A HAZARDOUS ENVIRONMENT, OR REQUIRING FAIL-SAFE PERFORMANCE, OR IN WHICH THE FAILURE OF PRODUCTS COULD LEAD DIRECTLY TO DEATH, PERSONAL INJURY, OR SEVERE PHYSICAL OR ENVIRONMENTAL DAMAGE (COLLECTIVELY, "HIGH RISK APPLICATIONS").

You understand and agree that your use of Kontron devices as a component in High Risk Applications is entirely at your risk. To minimize the risks associated with your products and applications, you should provide adequate design and operating safeguards. You are solely responsible for compliance with all legal, regulatory, safety, and security related requirements concerning your products. You are responsible to ensure that your systems (and any Kontron hardware or software components incorporated in your systems) meet all applicable requirements. Unless otherwise stated in the product documentation, the Kontron device is not provided with error-tolerance capabilities and cannot therefore be deemed as being engineered, manufactured or setup to be compliant for implementation or for resale as device in High Risk Applications. All application and safety related information in this document (including application descriptions, suggested safety measures, suggested Kontron products, and other materials) is provided for reference only.

CAUTION

Handling and operation of the product is permitted only for trained personnel within a work place that is access controlled. Please follow the "General Safety Instructions" supplied with the system.

NOTICE

You find the most recent version of the "General Safety Instructions" online in the download area of this product.

Revision History

Revision	Brief Description of Changes	Date of Issue	Author/ Editor
1.0	Initial Issue	2020-Dec-18	MK
1.1	UEFI BIOS recovery procedure corrected	2021-Feb-23	MK
1.2	Word2016 issues	2021-Apr-27	hjs
1.3	RAID, power, temperature, BIOS information added	2021-May-27	MK
1.4	DIP Switch settings corrected	2021-Oct-25	MK

Terms and Conditions

Kontron warrants products in accordance with defined regional warranty periods. For more information about warranty compliance and conformity, and the warranty period in your region, visit <http://www.kontron.com/terms-and-conditions>.

Kontron sells products worldwide and declares regional General Terms & Conditions of Sale, and Purchase Order Terms & Conditions. Visit <http://www.kontron.com/terms-and-conditions>.

For contact information, refer to the corporate offices contact information on the last page of this user guide or visit our website [CONTACT US](#).

Customer Support

Find Kontron contacts by visiting: <https://www.kontron.de/support-and-services>.

Customer Service

As a trusted technology innovator and global solutions provider, Kontron extends its embedded market strengths into a services portfolio allowing companies to break the barriers of traditional product lifecycles. Proven product expertise coupled with collaborative and highly-experienced support enables Kontron to provide exceptional peace of mind to build and maintain successful products.

For more details on Kontron's service offerings such as: enhanced repair services, extended warranty, Kontron training academy, and more visit <https://www.kontron.de/support-and-services>.

Symbols

The following symbols may be used in this user guide

⚠ DANGER

DANGER indicates a hazardous situation which, if not avoided, will result in death or serious injury.

⚠ WARNING

WARNING indicates a hazardous situation which, if not avoided, could result in death or serious injury.

NOTICE

NOTICE indicates a property damage message.

⚠ CAUTION

CAUTION indicates a hazardous situation which, if not avoided, may result in minor or moderate injury.



Electric Shock!

This symbol and title warn of hazards due to electrical shocks (> 60 V) when touching products or parts of products. Failure to observe the precautions indicated and/or prescribed by the law may endanger your life/health and/or result in damage to your material.



ESD Sensitive Device!

This symbol and title inform that the electronic boards and their components are sensitive to static electricity. Care must therefore be taken during all handling operations and inspections of this product in order to ensure product integrity at all times.



HOT Surface!

Do NOT touch! Allow to cool before servicing.



Laser!

This symbol inform of the risk of exposure to laser beam and light emitting devices (LEDs) from an electrical device. Eye protection per manufacturer notice shall review before servicing.



This symbol indicates general information about the product and the user guide.

This symbol also indicates detail information about the specific product configuration.



This symbol precedes helpful hints and tips for daily use.

For Your Safety

Your new Kontron product was developed and tested carefully to provide all features necessary to ensure its compliance with electrical safety requirements. It was also designed for a long fault-free life. However, the life expectancy of your product can be drastically reduced by improper treatment during unpacking and installation. Therefore, in the interest of your own safety and of the correct operation of your new Kontron product, you are requested to conform with the following guidelines.

High Voltage Safety Instructions

As a precaution and in case of danger, the power connector must be easily accessible. The power connector is the product's main disconnect device.

⚠ CAUTION

Warning

All operations on this product must be carried out by sufficiently skilled personnel only.

⚠ CAUTION



Electric Shock!

Before installing a non hot-swappable Kontron product into a system always ensure that your mains power is switched off. This also applies to the installation of piggybacks. Serious electrical shock hazards can exist during all installation, repair, and maintenance operations on this product. Therefore, always unplug the power cable and any other cables which provide external voltages before performing any work on this product.

Earth ground connection to vehicle's chassis or a central grounding point shall remain connected. The earth ground cable shall be the last cable to be disconnected or the first cable to be connected when performing installation or removal procedures on this product.

Special Handling and Unpacking Instruction

NOTICE



ESD Sensitive Device!

Electronic boards and their components are sensitive to static electricity. Therefore, care must be taken during all handling operations and inspections of this product, in order to ensure product integrity at all times.

Do not handle this product out of its protective enclosure while it is not used for operational purposes unless it is otherwise protected.

Whenever possible, unpack or pack this product only at EOS/ESD safe work stations. Where a safe work station is not guaranteed, it is important for the user to be electrically discharged before touching the product with his/her hands or tools. This is most easily done by touching a metal part of your system housing.

It is particularly important to observe standard anti-static precautions when changing piggybacks, ROM devices, jumper settings etc. If the product contains batteries for RTC or memory backup, ensure that the product is not placed on conductive surfaces, including anti-static plastics or sponges. They can cause short circuits and damage the batteries or conductive circuits on the product.

Lithium Battery Precautions

If your product is equipped with a lithium battery, take the following precautions when replacing the battery.

⚠ CAUTION

Danger of explosion if the battery is replaced incorrectly.

- ▶ Replace only with same or equivalent battery type recommended by the manufacturer.
 - ▶ Dispose of used batteries according to the manufacturer's instructions.
-

General Instructions on Usage

In order to maintain Kontron's product warranty, this product must not be altered or modified in any way. Changes or modifications to the product, that are not explicitly approved by Kontron and described in this user guide or received from Kontron Support as a special handling instruction, will void your warranty.

This product should only be installed in or connected to systems that fulfill all necessary technical and specific environmental requirements. This also applies to the operational temperature range of the specific board version that must not be exceeded. If batteries are present, their temperature restrictions must be taken into account.

In performing all necessary installation and application operations, only follow the instructions supplied by the present user guide.

Keep all the original packaging material for future storage or warranty shipments. If it is necessary to store or ship the product then re-pack it in the same manner as it was delivered.

Special care is necessary when handling or unpacking the product. See Special Handling and Unpacking Instruction.

Quality and Environmental Management

Kontron aims to deliver reliable high-end products designed and built for quality, and aims to complying with environmental laws, regulations, and other environmentally oriented requirements. For more information regarding Kontron's quality and environmental responsibilities, visit <http://www.kontron.com/about-kontron/corporate-responsibility/quality-management>.

Disposal and Recycling

Kontron's products are manufactured to satisfy environmental protection requirements where possible. Many of the components used are capable of being recycled. Final disposal of this product after its service life must be accomplished in accordance with applicable country, state, or local laws or regulations.

WEEE Compliance

The Waste Electrical and Electronic Equipment (WEEE) Directive aims to:

- ▶ Reduce waste arising from electrical and electronic equipment (EEE)
- ▶ Make producers of EEE responsible for the environmental impact of their products, especially when the product become waste
- ▶ Encourage separate collection and subsequent treatment, reuse, recovery, recycling and sound environmental disposal of EEE
- ▶ Improve the environmental performance of all those involved during the lifecycle of EEE



Environmental protection is a high priority with Kontron.

Kontron follows the WEEE directive

You are encouraged to return our products for proper disposal.

Table of Contents

Symbols	6
For Your Safety	7
High Voltage Safety Instructions	7
Lithium Battery Precautions.....	8
General Instructions on Usage	8
Quality and Environmental Management	8
Disposal and Recycling.....	8
WEEE Compliance.....	8
Table of Contents	9
List of Tables	13
List of Figures	14
1/ General Safety Instructions	17
1.1. Electrostatic Discharge (ESD).....	19
1.1.1. Grounding Methods.....	19
1.2. Instructions for the optional Lithium Battery.....	19
2/ Electromagnetic Compatibility (Class B Device)	20
2.1. Electromagnetic Compatibility (EU).....	20
2.2. FCC Statement (USA).....	20
2.3. EMC-Compliance (Canada)	20
3/ Shipment and Unpacking	21
3.1. Unpacking	21
3.2. Scope of Delivery.....	21
3.2.1. Optional Parts (System Expansion).....	21
3.2.2. Optional System Extension.....	21
3.3. Spare Parts	22
3.4. Type Label and Product Identification	22
4/ System Overview	23
4.1. RTC (GoldCap)	25
4.1.1. RTC Buffer Time.....	25
4.1.2. Setting the RTC.....	25
4.2. Optional RTC Lithium Battery (internally-accessible).....	26
4.3. System Expansion Capabilities.....	26
4.3.1. M.2 Interfaces.....	26
4.3.2. Mini PCI Express® Interface.....	26
4.3.3. Standard PCI Express® Interfaces.....	26
4.3.4. SATA Interfaces.....	26
4.3.5. Internal USB 3.0 Interface	27
4.3.6. Internal microSD Card and microSIM Card Interface.....	27
4.4. KBox C-103-CFL-2 Variant	29
4.5. Front Side Configuration and Options - KBox C-103-CFL.....	31
4.5.1. X101/X201 – Power Input Connectors.....	32
4.5.2. X102/X105/X108/X111 – Ethernet Connectors (ETH).....	32
4.5.3. X103/X106/X109 - USB 3.0.....	32
4.5.4. X104/X107/X110 - USB 2.0	32
4.5.5. X112/X113/X203 - DisplayPorts.....	33
4.5.6. X114 - RS232/422/485 Port	33
4.5.7. POWER Button and PWR LED	33

4.5.8. RESCUE Button and RSQ LED	34
4.5.9. Status and General Purpose LEDs.....	34
4.5.10. PCI/PCIe Expansion Slots	35
4.5.11. Internal or Removable 2.5" SATA HDDs/SSDs.....	36
4.5.11.1. Installing/Removing the removable HDD/SSD.....	37
4.6. Left and Right Side View	38
4.7. Top and Bottom Side View	38
4.8. Rear Side View.....	39
4.9. Functional Earth Stud	39
5/ System Extensions	40
5.1. X201 to X206 - Possible Interface Combinations	41
5.2. (X205) - Serial Port RS232/RS422.....	41
5.3. LTE M.2 module.....	41
5.4. (X204) - CAN Port.....	41
5.5. (X203) - 3 rd DisplayPort.....	42
5.6. (X202) - WideLink Port	42
5.7. (X201 or X206) Fieldbus or WiFi.....	42
5.7.1. Fieldbus	42
5.7.2. WiFi/BT	43
5.8. (X201) 2 nd 24 VDC Input	43
5.9. 8-Channel GPIO/DIO Interface.....	44
5.10. Optional Versions with Fan Tray - KBox C-103-CFL-4/-2/-1	47
5.10.1. Fan Tray (only for KBox C-103-CFL-4/-2/-1).....	48
6/ Accessing Internal Components.....	49
6.1. Top Cover	50
6.2. Opening and Closing the KBox C-103-CFL.....	51
6.3. Internal View	53
6.3.1. Integrated COMe Module	54
6.3.2. M.2 Sockets.....	54
6.3.3. DIP Switch.....	55
6.3.4. Expansion Socket for PCIe Mini Cards.....	55
6.3.5. Riser Cards Expansion Sockets for PCI/PCIe Cards	55
6.3.5.1. Riser Cards for KBox C-103-CFL-x.....	56
6.3.5.2. Detail: Riser Card for KBox C-103-CFL-4.....	57
6.3.6. Installing/Removing PCI/PCIe Expansion Cards (KBox C-103-CFL-4/-2/-1 only).....	58
6.3.7. Installing/Removing an M.2 Module	60
6.3.8. Installing/Removing a microSD/microSIM Card.....	61
7/ Power and Thermal Considerations	62
7.1. System Power Portfolio	62
7.2. Tuning CPU Power and Performance.....	63
7.3. Available Processors	63
7.4. Convection Cooling	63
7.5. Active Cooling via the optional Fan Tray.....	63
7.6. Minimum System Clearance	64
7.7. Maximum Temperatures.....	64
7.8. Third Party Components	64
7.9. Processor Thermal Monitoring.....	64
7.10. Processor Thermal Trip Feature.....	65
8/ Installation Instructions.....	66

8.1. Specifications of the internal M.2 Connectors.....	67
8.2. Control Cabinet Mounting	67
8.3. DC Power Plug Terminal	72
8.3.1. Cabling.....	72
8.4. Side Wall Mounting (Option).....	73
9/ Starting Up.....	74
9.1. Connecting to DC Main Power Supply	74
9.2. Power OFF/ON Procedure.....	75
9.3. Operating System and Hardware Component Drivers	75
10/ Maintenance and Cleaning	76
10.1. Replacing the Lithium Battery.....	76
10.2. Preventive Maintenance for SSD Drives	77
10.3. Replacing the Fan Tray	77
10.4. Cleaning the Air Filter.....	78
11/ uEFI BIOS	80
11.1. Starting the uEFI BIOS.....	80
11.2. Setup Menus	81
11.2.1. Main Setup Menu	82
11.2.2. Advanced Setup Menu.....	84
11.2.3. Chipset Setup Menu	90
11.2.3.1. Chipset: System Agent Configuration.....	91
11.2.3.2. Chipset > PCH-IO Configuration	92
11.2.4. Security Setup Menu.....	95
11.2.4.1. Remember the Password.....	96
11.2.5. Boot Setup Menu	97
11.2.6. Save and Exit Setup Menu.....	98
11.3. The uEFI Shell.....	99
11.3.1. Basic Operation of the uEFI Shell	99
11.3.1.1. Entering the uEFI Shell	99
11.3.1.2. Exiting the uEFI Shell.....	99
11.4. uEFI Shell Scripting	100
11.4.1. Startup Scripting.....	100
11.4.2. Create a Startup Script.....	100
11.4.3. Examples of Startup Scripts	100
11.4.3.1. Execute Shell Script on Other Harddrive.....	100
11.5. Updating the uEFI BIOS.....	101
11.5.1. Updating Procedure	101
11.5.2. uEFI BIOS Recovery.....	101
11.5.3. Determining the Active Flash.....	101
12/ KBox C-103-CFL CPLD Specific Registers.....	102
12.1. Register Overview	102
12.2. Register Descriptions	103
12.2.1. Status Register 0 STAT0.....	103
12.2.2. Control Register 0 CTRL0.....	103
12.2.3. Reset Status Register RSTAT.....	104
12.2.4. Board interrupt configuration BICFG	105
12.2.5. Board ID Register High Byte BIDH	106
12.2.6. PLD Revision Register	106
12.2.7. PLD Revision Register	106

12.2.8. Board ID Register Low Byte BIDL	107
12.2.9. LED Configuration Register LCFG	107
12.2.10. LED Control Register LCTRL	108
12.2.11. Temperature Status Register TMPSR.....	109
12.2.12. Index Register IDX	110
12.2.13. Data Register DATA.....	110
12.3. Extended Registers	110
12.3.1. DIP switch Status Register DIPSW	111
13/ Technical Specifications	112
13.1. Mechanical Specifications of the KBox C-103-CFL.....	114
13.1.1. Mechanical Specifications of the KBox C-103-CFL-4	114
13.1.2. Mechanical Specifications of the KBox C-103-CFL-4 with Fan Tray Option	115
13.1.3. Mechanical Specifications of the KBox C-103-CFL-2.....	117
13.1.4. Mechanical Specifications of the KBox C-103-CFL-2 with Fan Tray Option	118
13.1.5. Mechanical Specifications of the KBox C-103-CFL-1.....	120
13.1.6. Mechanical Specifications of the KBox C-103-CFL-1 with Fan Tray Option	121
13.1.7. Mechanical Specifications of the KBox C-103-CFL-0.....	123
13.2. Environmental Specifications.....	125
13.3. Standards, Certifications and Directives Compliance	126
13.4. Power Supply Specification	128
13.4.1. Power Supply Protection Requirements.....	128
13.4.2. Power Consumption.....	129
13.4.3. Protective Earth Stud Bolt.....	129
14/ Standard Interfaces – Pin Assignments	130
14.1.1. (X101) Power Input Connector.....	130
14.1.2. (X102, X105, X108, X111) Ethernet Connectors	130
14.1.3. (X103, X106, X109) USB 3.0 Ports	131
14.1.4. (X104, X107, X110) USB 2.0 Ports.....	131
14.1.5. (X112, X113, X203) DisplayPorts.....	131
14.1.6. (X114) Serial Interface COM 1 (RS232, RS422, RS485).....	132
14.2. Optional Interfaces via Adapter Modules.....	134
14.2.1. (X201) 2 nd Power Input Connector	134
14.2.2. (X 202) WideLink	134
14.2.3. (X 203) 3 rd DisplayPort	134
14.2.4. (X 205) Serial Port RS232/RS422	135
14.2.4.1. Serial Port RS232/RS422 configured as RS232	135
14.2.4.2. Serial Port RS232/RS422 configured as RS422	135
14.2.5. (X 204) CAN Bus Port	136
Appendix A: List of Acronyms.....	137
About Kontron – Member of the S&T Group	138

List of Tables

Table 1: Spare Parts available for Field Replacement.....	22
Table 2: Product Identification Table.....	22
Table 3: KBox C-103-CFL Front Side Configuration.....	31
Table 4: Status and General Purpose LEDs.....	34
Table 5: X201 to X206 Configuration Options.....	41
Table 6: WiFi/BT Expansion Card Option.....	43
Table 7: GPIO connector pinout.....	44
Table 8: GPIO misc. specifications.....	44
Table 9: GPIO output channel.....	45
Table 10: GPIO input channel.....	45
Table 11: GPIO connector and mating connector.....	46
Table 12: Available Riser Cards for the different KBox C-103-CFL variants.....	56
Table 13: Power Consumption.....	62
Table 14: Current and voltage provided in the KBOX C-103-CFL per port.....	62
Table 15: Maximum Power supplied on the PCIe Slots (depending on the installed PCIe expansion card).....	62
Table 16: Default values in BIOS for KBOX C-103-CFL.....	63
Table 17: Overview of some of the features of the used CPU versions in KBOX C-103-CFL.....	63
Table 18: Maximum Temperatures.....	64
Table 19: Specifications of the internal M.2 Connectors.....	67
Table 20: Navigation Hot Keys Available in the Legend Bar.....	80
Table 21: Main Setup Menu Sub-screens and Functions.....	82
Table 22: Advanced Setup menu Sub-screens and Functions.....	84
Table 23: Chipset: System Agent Configuration Sub-screens and Functions.....	91
Table 24: Chipset Set > PCH-IO Configuration Sub-screens and Functions.....	92
Table 25: Setting Overview for Real Time Behaviour.....	94
Table 26: Security Setup Menu Functions.....	95
Table 27: Boot Setup Menu Functions.....	97
Table 28: Save and Exit Setup Menu Functions.....	98
Table 29: Register Overview.....	102
Table 30: Status Register 0 STAT0.....	103
Table 31: Decoding of Flash selection status.....	103
Table 32: Control Register 0 CTRL0.....	103
Table 33: Reset Status Register RSTAT.....	104
Table 34: Board interrupt configuration BICFG.....	105
Table 35: Power Management Interrupt Configuration.....	105
Table 36: CAN Interrupt Configuration.....	105
Table 37: Board ID Register High Byte BIDH.....	106
Table 38: PLD Revision Register FREV.....	106
Table 39: Board Revision Register BREV.....	106
Table 40: Board ID Register Low Byte BIDL.....	107
Table 41: LED Configuration Register LCFG.....	107
Table 42: LED Control Register LCTRL.....	108
Table 43: Temperature Status Register TMPSR.....	109
Table 44: Index Register IDX.....	110
Table 45: Data Register DATA.....	110
Table 46: DIP switch Status Register DIPSW.....	111
Table 47: Technical Specifications.....	112
Table 48: Mechanical Specifications of the KBox C-103-CFL-4.....	116
Table 49: Mechanical Specifications of the KBox C-103-CFL-2.....	119
Table 50: Mechanical Specifications of the KBox C-103-CFL-1.....	122
Table 51: Mechanical Specifications of the KBox C-103-CFL-0.....	124
Table 52: Environmental Specifications.....	125
Table 53: Standards, Certifications and Directives Compliance.....	126
Table 54: Electrical Safety.....	127

Table 55: EMC.....	127
Table 56: KBox C-103-CFL-x Electrical Specification	128
Table 57: (X101) Power Input Connector	130
Table 58: (X102, X105, X108, X111) Ethernet Connectors.....	130
Table 59: (X103, X106, X109) USB 3.0 Ports.....	131
Table 60: (X104, X107, X110) USB 2.0 Ports	131
Table 61: (X112, X113, X203) DisplayPorts.....	131
Table 62: (X114) Serial Interface COM 1, configured as RS232).....	132
Table 63: (X114) Serial Interface COM 1, configured as single RS485	132
Table 64: (X114) Serial Interface COM 1, configured as single RS422	132
Table 65: (X114) Serial Interface COM 1 and COM2, configured as dual RS485	133
Table 66: (X114) Serial Interface COM 1 and COM2, configured as dual RS422	133
Table 67: (X201) WideLink.....	134
Table 68: Serial Port RS232/RS422 configured as RS232.....	135
Table 69: Serial Port RS232/RS422 configured as RS422.....	135
Table 70: (X204) CAN Bus Port	136
Table 71: List of Acronyms (Example).....	137

List of Figures

Figure 1: Example of KBox C-103-CFL type label.....	22
Figure 2: KBox C-103-CFL Family	23
Figure 3: RTC buffer time depending on temperature	25
Figure 4: Bottom side view.....	28
Figure 5: Right side view.....	28
Figure 6: Front side view config. with removable drives	28
Figure 7: Front side view config. without removable drives.....	28
Figure 8: Left side view.....	28
Figure 9: Top side view	28
Figure 10: Rear side view.....	28
Figure 11: KBox C-103-CFL-2 - front view (shown with removable drive bays and without mounting brackets).....	29
Figure 12: Block Diagram - KBox C-103-CFL-x.....	30
Figure 13: KBox C-103-CFL-4 with fan tray.....	31
Figure 14: X101 - 24VDC power input connector	32
Figure 15: Detail - Power button and PWR LED/Rescue button and RSQ LED	33
Figure 16: Detail - Status and General Purpose LEDs.....	34
Figure 17: PCIe 1 to PCIe 4 slots (shown as detail of a KBox C-103-CFL-4).....	35
Figure 18: Drive 1 and Drive 2 for removable 2.5" SATA HDD/SSD (option); closed drive bays.....	36
Figure 19: Drive bay 1 with opened drive bay cover	36
Figure 20: Inserting/removing a 2.5" removable SSD	36
Figure 21: Right side of the KBox C-103-CFL system	38
Figure 22: Left side of the KBox C-103-CFL system.....	38
Figure 23: Top side of the KBox C-103-CFL system	38
Figure 24: Bottom side of the KBox C-103-CFL system.....	38
Figure 25: Rear side of the KBox C-103-CFL-2 system	39
Figure 26: KBox C-103-CFL-4 shown with optional interfaces and with removable drive bays.....	40
Figure 27: X201 or X206 - Locations for the optional FIELDBUS interface	42
Figure 28: Second power input (X201)	43
Figure 29: GPIO connector (cable terminal side of mating connector)	44
Figure 30: Output application connected to GPIO.....	45
Figure 31: Input application connected to GPIO	46
Figure 32: KBox C-103-CFL-1 equipped with the optional fan tray.....	47
Figure 33: Fan tray components of the KBox C-103-CFL-4/-2/-1.....	48
Figure 34: Inside of the top cover with centering and fixing brackets	50
Figure 35: Removing the centering and fixing bracket of the top cover (detail of the KBox C-103-CFL-2).....	51
Figure 36: Removing the cover (detail of the KBox C-103-CFL-2)	51

Figure 37: KBox C-103-CFL-2 - removing the right side cover	52
Figure 38: KBox C-103-CFL-2 without top and right side cover (shown with a PCIe riser card)	52
Figure 39: KBox C-103-CFL-2 - internal view (shown with a PCIe riser card and removable HDD/SSD drive bay)	53
Figure 40: KBox C-103-2 - internal view with COMExpress® module and with PCIe riser card	54
Figure 41: Riser card with 2xPCIe x4 and 2x PCIe x1 slots for KBox C-103-4	57
Figure 42: Detail of the KBox C-103-CFL-2 with PCIe riser card with 2x PCIe x4 sockets	58
Figure 43: Detail of the KBox C-103-CFL-2 with PCI-PCIe riser card with 1x PCI (32 bit) and 1x PCIe x4 sockets	58
Figure 44: Detail of the KBox C-103-CFL-4 with PCIe riser card with 2x PCIe x4 and 2x PCIe x1 sockets	58
Figure 45: microSD/microSIM combo connector	61
Figure 46: Keep out area for mounting around KBox C-103-CFL-4 (front side view without fan tray)	68
Figure 47: Keep out area for mounting around KBox C-103-CFL-4 (front side view with optional fan tray)	68
Figure 48: Keep out area for mounting around KBox C-103-CFL-2 (front side view without fan tray)	69
Figure 49: Keep out area for mounting around KBox C-103-CFL-2 (front side view with optional fan tray)	69
Figure 50: Keep out area for mounting around KBox C-103-CFL-1 (front side view without fan tray)	70
Figure 51: Keep out area for mounting around KBox C-103-CFL-1 (front side view with optional fan tray)	70
Figure 52: Keep out area for mounting around KBox C-103-CFL-0	71
Figure 53: Phoenix power plug terminal	72
Figure 54: KBox C-103-CFL-2 with fan tray and side wall mounting brackets	73
Figure 55: Location of the optional Lithium battery	76
Figure 56: Lithium battery polarity	76
Figure 57: Fan tray extension (detail: shown as KBox C-103-CFL-1)	78
Figure 58: KBox C-103-CFL-2 with removed fan tray and removed air filter	79
Figure 59: Filter mat Holder without air filter	79
Figure 60: Holder (shown for KBox C-103-CFL-2) with air filter	79
Figure 61: Air filter (shown for KBox C-103-CFL-2)	79
Figure 62: Main Setup Menu	82
Figure 63: Avanced Setup Menu	84
Figure 64: Chipset Setup Menu	90
Figure 65: Security Setup Menu	95
Figure 66: Boot Setup Menu	97
Figure 67: Save and Exit Setup Menu	98
Figure 68: Dimensions: right side (KBox C-103-CFL-4)	114
Figure 69: Dimensions: front side with key holes (KBox C-103-CFL-4)	114
Figure 70: Dimensions: detail key hole (KBox C-103-CFL-4)	114
Figure 71: Dimensions: top side (KBox C-103-CFL-4)	114
Figure 72: Dimensions: right side (KBox C-103-CFL-4 with fan tray option)	115
Figure 73: Dimensions: front side with key holes (KBox C-103-CFL-4 with fan tray option)	115
Figure 74: Dimensions: detail key hole (KBox C-103-CFL-4 with fan tray option)	115
Figure 75: Dimensions: top side (KBox C-103-CFL-4 with fan trayoption)	115
Figure 76: Dimensions: right side (KBox C-103-CFL-2)	117
Figure 77: Dimensions: front side with key holes (KBox C-103-CFL-2)	117
Figure 78: Dimensions: detail key hole (KBox C-103-CFL-2)	117
Figure 79: Dimensions: top side (KBox C-103-CFL-2)	117
Figure 80: Dimensions: right side (KBox C-103-CFL-2 with fan tray option)	118
Figure 81: Dimensions: front side with key holes (KBox C-103-CFL-2 with fan tray option)	118
Figure 82: Dimensions: detail key hole (KBox C-103-CFL-2 with fan tray option)	118
Figure 83: Dimensions: top side (KBox C-103-CFL-2 with fan trayoption)	118
Figure 84: Dimensions: right side (KBox C-103-CFL-1)	120
Figure 85: Dimensions: front side with key holes (KBox C-103-CFL-1)	120
Figure 86: Dimensions: detail key hole (KBox C-103-CFL-1)	120
Figure 87: Dimensions: top side (KBox C-103-CFL-1)	120
Figure 88: Dimensions: right side (KBox C-103-CFL-1 with fan tray option)	121
Figure 89: Dimensions: front side with key holes (KBox C-103-CFL-1 with fan tray option)	121
Figure 90: Dimensions: detail key hole (KBox C-103-CFL-1 with fan tray option)	121
Figure 91: Dimensions: top side (KBox C-103-CFL-1 with fan tray option)	121
Figure 92: Dimensions: right side (KBox C-103-CFL-0)	123

Figure 93: Dimensions: front side with key holes (KBox C-103-CFL-0)123
Figure 94: Dimensions: detail key hole (KBox C-103-CFL-0)123
Figure 95: Dimensions: top side (KBox C-103-CFL-0)123
Figure 96: RS485 Echo mode configuration133

1/ General Safety Instructions

⚠ WARNING



Please read this chapter carefully and take careful note of the instructions, which have been compiled for your safety and to ensure to apply in accordance with intended regulations. If the following general safety instructions are not observed, it could lead to injuries to the operator and/or damage of the product; in cases of nonobservance of the instructions Kontron is exempt from accident liability, this also applies during the warranty period.

The product has been built and tested according to the basic safety requirements for low voltage (LVD) applications and has left the manufacturer in safety-related, flawless condition. To maintain this condition and also to ensure safe operation, the operator must not only observe the correct operating conditions for the product but also the following general safety instructions:

- ▶ The product must be used as specified in the product documentation, in which the instructions for safety for the product and for the operator are described. These contain guidelines for setting up, installation and assembly, maintenance, transport or storage.
- ▶ The on-site electrical installation must meet the requirements of the country's specific local regulations.
- ▶ The product must be connected only to a certified mains power supply complying with the requirements of IEC 60950-1 or IEC 62368-1 standard or better.
- ▶ If a power supply comes with the product, only this power supply should be used to supply the product.
- ▶ If a power cable for your region comes with the product, only this cable should be used to supply the product.
- ▶ Do not use an extension cable to connect the product.
- ▶ To guarantee that sufficient air circulation is available to cool the product, please ensure that the ventilation openings are not covered or blocked. If an air filter is provided, this should be cleaned regularly. Do not place the system close to heat sources or damp places. Make sure the system is well ventilated.
- ▶ Only devices or parts that fulfill the safety requirements as stipulated by the applied safety standards may be connected to the available interfaces.
- ▶ Before opening the device, make sure that the device is disconnected from the mains.
- ▶ Switching off the device by its power button does not disconnect it from the mains. Complete disconnection is only possible if the power cable is removed from the wall plug or from the device. Ensure that there is free and easy access to enable disconnection.
- ▶ The device may only be opened for the insertion or removal of add-on cards (depending on the configuration of the system). This may only be carried out by qualified operators.
- ▶ If extensions are being carried out, the following must be observed:
 - ▶ All effective legal regulations and all technical data are adhered to.
 - ▶ The power consumption of any add-on card does not exceed the specified limitations.
 - ▶ The current consumption of the system does not exceed the value stated on the product label.
- ▶ Only original accessories that have been approved by Kontron can be used.
- ▶ Please note: safe operation is no longer possible when any of the following applies:
 - ▶ The device has visible damages.
 - ▶ The device is no longer functioning.

In this case the device must be switched off and it must be ensured that the device can no longer be operated.

Additional safety instructions for DC power supply circuits

- ▶ To guarantee safe operation of devices with DC power supply voltages larger than 60 volts DC or a power consumption larger than 240 VA, please observe that:
 - ▶ no cables or parts without insulation in electrical circuits with dangerous voltage or power should be touched directly or indirectly
 - ▶ a reliable protective earthing connection is provided
 - ▶ a suitable, easily accessible disconnecting device is used in the application (e.g. overcurrent protective device), if the device itself is not disconnectable
 - ▶ a disconnect device, if provided in or as part of the equipment, shall disconnect both poles simultaneously
 - ▶ interconnecting power circuits of different devices cause no electrical hazards
- ▶ A sufficient dimensioning of the power cable wires must be selected – according to the maximum electrical specifications on the product label – as stipulated by the applied safety standards.
- ▶ The product does not generally fulfill the requirements for "centralized DC power systems" as stipulated by the applied safety standards and therefore may not be connected to such devices!

1.1. Electrostatic Discharge (ESD)



A sudden discharge of electrostatic electricity can destroy static-sensitive devices or micro-circuitry.

Therefore proper packaging and grounding techniques are necessary precautions to prevent damage. Always take the following precautions:

1. Transport boards in ESD-safe containers such as boxes or bags.
2. Keep electrostatic sensitive parts in their containers until they arrive at the ESD-safe workplace.
3. Always be properly grounded when touching a sensitive board, component, or assembly.
4. Store electrostatic-sensitive boards in protective packaging or on antistatic mats.

1.1.1. Grounding Methods

By adhering to the guidelines below, electrostatic damage to the device can be avoided:

1. Cover workstations with approved antistatic material. Always wear a wrist strap connected to workplace. Always use properly grounded tools and equipment.
2. Use antistatic mats, heel straps, or air ionizers for more protection.
3. Always handle electrostatically sensitive components by their edge or by their casing.
4. Avoid contact with pins, leads, or circuitry.
5. Turn off power and input signals before inserting and removing connectors or connecting test equipment.
6. Keep work area free of non-conductive materials such as ordinary plastic assembly aids and Styrofoam.
7. Use only field service tools which are conductive, such as cutters, screwdrivers, and vacuum cleaners.
8. Always place drives and boards PCB-assembly-side down on the foam.

1.2. Instructions for the optional Lithium Battery

If ordered, your KBox C-103-CFL is equipped with an optional lithium battery. For the replacement of this battery please observe the instructions described in section 4.2 "Optional RTC Lithium Battery (internally-accessible)".

⚠ WARNING

Danger of explosion when replacing with wrong type of battery. Replace only with the same or equivalent type recommended by the manufacturer. The lithium battery type must be UL recognized.



Do not dispose of lithium batteries in general trash collection. Dispose of the battery according to the local regulations dealing with the disposal of these special materials, (e.g. to the collecting points for dispose of batteries).

2/ Electromagnetic Compatibility (Class B Device)

2.1. Electromagnetic Compatibility (EU)

This product complies with the European Council Directive on the approximation of the laws of the member states relating to electromagnetic compatibility (2014/30/EC), Class B limits for Information Technology Equipment according to European Standard EN 55032.

2.2. FCC Statement (USA)

The following statement applies to the products covered in this manual, unless otherwise specified herein. The statement for other products will appear in the accompanying documentation.

This equipment has been tested and found to comply with the limits for a Class B digital device, pursuant to Part 15 of the FCC Rules. These limits are designed to provide reasonable protection against harmful interference in a residential installation. This equipment generates, uses and can radiate radio frequency energy and, if not installed and used in accordance with the instructions, may cause harmful interference to radio communications. However, there is no guarantee that interference will not occur in a particular installation.

If this equipment does cause harmful interference to radio or television reception, which can be determined by turning the equipment off and on, the user is encouraged to try to correct the interference by one or more of the following measures:

- ▶ Reorient or relocate the receiving antenna.
- ▶ Increase the separation between the equipment and receiver.
- ▶ Connect the equipment into an outlet on a circuit different from that to which the receiver is connected.
- ▶ Consult the dealer or an experienced radio/TV technician for help.

Kontron Europe GmbH is not responsible for any radio television interference caused by unauthorized modifications of this equipment or the substitution or attachment of connecting cables and equipment other than those specified by Kontron Europe GmbH. The correction of interference caused by such unauthorized modification, substitution or attachment will be the responsibility of the user.

The use of shielded I/O cables is required when connecting this equipment to any and all optional peripheral or host devices. Failure to do so may violate FCC and ICES rules.

2.3. EMC-Compliance (Canada)

The method of compliance is self-declaration to Canadian ICES-003:

(English): This Class B digital apparatus complies with the Canadian ICES-003.

(French) : Cet appareil numérique de la class B est conforme à la norme NMB-003 du Canada.

3/ Shipment and Unpacking

3.1. Unpacking

Proceed as follows to unpack the unit:

1. Remove packaging.
2. Do not discard the original packaging. Keep it for future relocation.
3. Check the delivery for completeness by comparing it with your order.
4. Please keep the associated paperwork. It contains important information for handling the unit.
5. Check the contents for visible shipping damage.
6. If you notice any shipping damage or inconsistencies between the contents and your order, please contact Kontron for help and information.

3.2. Scope of Delivery

- ▶ KBox C-103-CFL (corresponding to the ordered system configuration)
- ▶ POWER-SUBCON PSC 1,5/ 3-F, 3-pin plug
- ▶ General Safety Instructions for Equipment

3.2.1. Optional Parts (System Expansion)

- ▶ Front accessible drive bays for 2.5" SATA HDD/SSDs
- ▶ M.2 cards
- ▶ PCIe cards
- ▶ USB Dongles

3.2.2. Optional System Extension

- ▶ RS232/RS422 Port: via internal factory mounted and configured RS232/RS422 adapter module
- ▶ CAN Port: via internal factory mounted CAN adapter module
- ▶ WideLink Port or DisplayPort (via internal factory mounted adapter modules)
- ▶ Optional internally accessible RTC lithium battery
- ▶ Optional fan tray
- ▶ Optional GPIO module
- ▶ Profibus, Profinet or Ethercat Fieldbus support: via internal factory mounted adapter module
- ▶ GSM (LTE) Support: via internal factory mounted adapter module
- ▶ WiFi support: via internal factory mounted adapter module
- ▶ Optional second 24 VDC power input



Please observe the different configuration options for each system of the KBox C-103-CFL family.
Refer to chapter 13/ "Technical Specifications " and the descriptions in this manual.

3.3. Spare Parts

Table 1: Spare Parts available for Field Replacement

Spare Part	Part Number		
	KBox C-103-CFL-4	KBox C-103-CFL-2	KBox C-103-CFL-1
Fan Tray	9-5000-1096	9-5000-1095	9-5000-1094
Air Filter	9-5000-1099	9-5000-1098	9-5000-1097

3.4. Type Label and Product Identification

The type label (product name, serial number, part number, production date) of your KBox C-103-CFL system is located on the right side of the device (refer to Figure 1 and Figure 21, pos. 9).

Figure 1: Example of KBox C-103-CFL type label

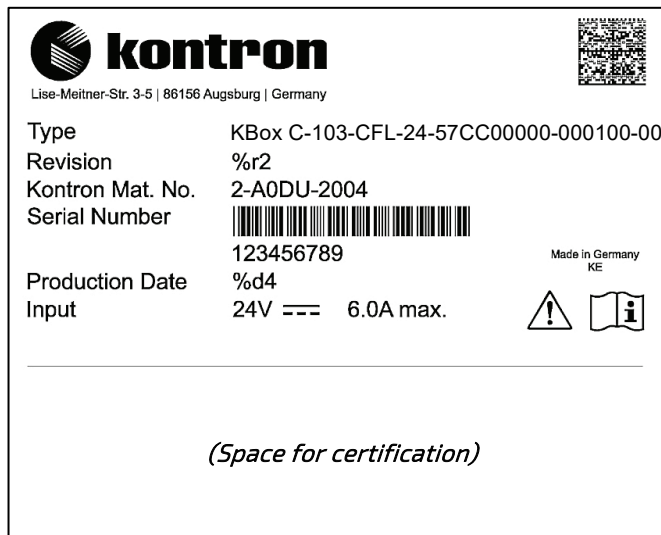


Table 2: Product Identification Table

System Type	Product Designation	Product Identifikation
KBox C	KBox C-103-CFL	KBox C-103-CFL-4: corresponds for system configurations with four slot rows for optional removable DRIVES and/or PCIe expansion slots
		KBox C-103-CFL-2: corresponds for system configurations with two slot rows for optional removable DRIVES and/or PCIe expansion slots
		KBox C-103-CFL-1: corresponds for system configurations with one slot row for optional removable DRIVE and/or PCIe expansion slot
		KBox C-103-CFL-0: corresponds for system configuration without any slot row for optional removable DRIVE and PCIe expansion slot

4/ System Overview

The KBox C-103-CFL Family is a highly scalable and flexible industrial computer platform that offers high-end performance for industrial automation application such as control or process monitoring.

The performance scalability is achieved by deploying various Kontron COMExpress® CPU modules (form factor basic and type 6 pinout) inside the system.

The system flexibility is a result of the basic design concept of using a baseboard which provides the COMExpress® and a set of standard IO interfacing plus a comprehensive optionally available IOs and devices.

The KBox C-103-CFL offers a maintenance free (wartungsfrei) operation. That means it operates without battery, fans and rotating media (HDD).

The KBox C-103-CFL family comprises four different chassis versions:

- ▶ The KBox C-103-CFL-4 with four PCIe expansion slots and spaces for up to two 2.5" SATA SSDs/HDDs
- ▶ The KBox C-103-CFL-2 with two PCI/PCIe expansion slots and spaces for up to two 2.5" SATA SSDs/HDDs
- ▶ The KBox C-103-CFL-1 with one PCIe expansion slot and space for one 2.5" SATA SSD/HDD
- ▶ The KBox C-103-CFL-0 without PCIe expansion slot and space for one internal 2.5" SATA SSD/HDD

Figure 2: KBox C-103-CFL Family



Standard Front Panel:

The following interfaces are available with the KBox C-103-CFL:

- ▶ 24VDC input power (X101, optional 2nd power input X201)
- ▶ 4x Gigabit Ethernet (X102, X105, X108, X111)
- ▶ 3x USB 3.0 (X103, X106, X109)
- ▶ 3x USB 2.0 (X104, X107, X110)
- ▶ 2x DisplayPort (X112, X113)
- ▶ RS232/422/485 serial port (X114)
- ▶ Buttons with corresponding LEDs:
 - ▶ RSQ (Rescue)
 - ▶ PWR (Power)
- ▶ LEDs:
 - ▶ GP1 to GP4 (general purpose LEDs)
 - ▶ THERM (thermal status)
 - ▶ DRIVE (SSD/HDD drive status)
 - ▶ M2 (M.2 card activity)
 - ▶ WD (Watchdog status)

Standard Baseboard - Onboard and System Expansion Capabilities:

- ▶ up to 4x SATA and power connector (for internal or removable devices, depending on the configuration)
- ▶ 1x Mini PCIe x1 socket (J20, on the lower side of the baseboard)
- ▶ 3x M.2 (J13, J17 and J18; 2x B type, 1x M type)
- ▶ 1x PCIe x8 socket for expansion via riser cards
- ▶ 1x USB3.0 port for e.g. connection of USB dongles (J14)
- ▶ MicroSIM and MicroSD card combo connector (J28)
- ▶ CR2032 coin battery (J29)

Optional System Extension:

- ▶ RS232/RS422 Port: via internal factory mounted and configured RS232/RS422 adapter module (X205)
- ▶ CAN Port: via internal factory mounted CAN adapter module (X204)
- ▶ DisplayPort or WideLink port (X203, X202; via corresponding internal factory mounted adapter modules)
- ▶ Optional fan tray (not possible for KBox C-103-CFL-0)
- ▶ Profibus, Profinet or Ethercat Fieldbus support: via internal factory mounted adapter module (X201, X206)
- ▶ LTE: via internal factory mounted adapter module
- ▶ WiFi: via corresponding internal factory mounted adapter module (X206)
- ▶ Optional second 24 VDC power input (X201)
- ▶ Optional GPIO module

The KBox C-103-CFL is a fanless system with a compact aluminum chassis with cooling fins which can be optionally equipped with a fan tray for active cooling (KBox C-103-CFL-1/-2/-4 only!)

The rated voltage range of the mains can be found on the type label. The type label is located at the right side of the device (Figure 21, pos. 9).

NOTICE

The KBox C-103-CFL is designed to be operated wall mounted inside a control cabinet, in vertical position, except with the top side facing down.

When you power on the KBox C-103-CFL, make sure that the air exhaust openings on the top side (Figure 23, pos. 12), the air intake openings on the bottom side (Figure 24, pos. 11) and the cooling fins of the chassis (Figure 22, Figure 23 and Figure 24, pos. 6) are not obstructed (covered) by any objects.

To provide sufficient heat dissipation via the cooling fins of the device, do not cover the cooling fins of the KBox C-103-CFL. Do not place any objects on the device. When installing the system, please observe the clearance recommendation (keep out area) in the subsection 8.2 "Control Cabinet Mounting"; refer to the marked areas in Figure 46 to Figure 52.

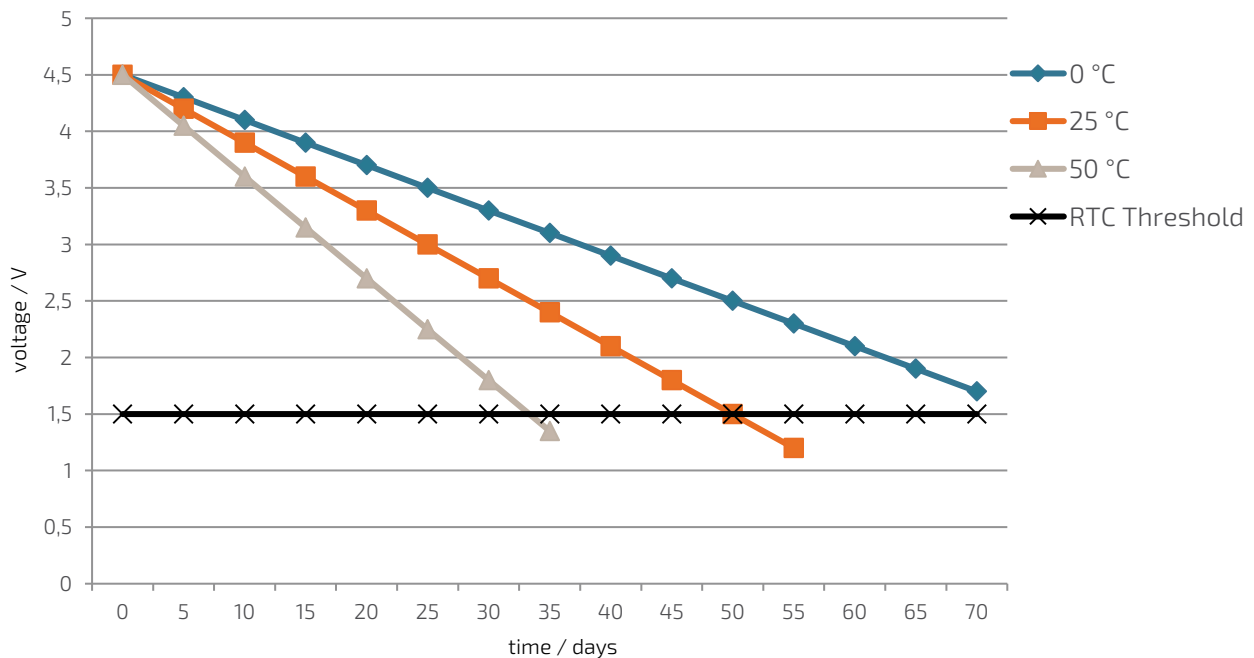
4.1. RTC (GoldCap)

The baseboard of the KBox C-103-CFL provides an RTC chip connected via the I²C Bus. An RTC chip of type RV-8803-C7 or compatible is used. To provide a valid date and time when no power is connected to the system, the carrier is equipped with a goldcap buffer.

4.1.1. RTC Buffer Time

The RTC buffer time is depending of the ambient temperature. For a better understanding the different behavior of the goldcap buffer integrated in your system, refer to the diagram below:

Figure 3: RTC buffer time depending on temperature



If the time is not valid this is indicated by a status bit in the RTC registers. For details see the RV-8803-C7 application manual.



To get the maximum buffer time, it is necessary to have the system a certain time powered on. This ensures that the buffer capacitors are fully loaded.

The buffer time depends on the ambient temperature and on how long the system is connected to the power supply.

4.1.2. Setting the RTC

External RTC will be automatically updated by setting time/date via EFI shell time/date command, or via BIOS Aptio Setup Main Menu (refer to chapter 11.2.1 "Main Setup Menu").

4.2. Optional RTC Lithium Battery (internally-accessible)

Your KBox C-103-CFL can be optionally equipped with an internally-accessible lithium battery (CMOS) (see Figure 55). The battery and the battery holder can be accessed after removing the topside access cover (see chapter 6.2 "Opening and Closing the KBox C-103-CFL").

For replacing the lithium battery, please follow the corresponding instructions in the section 10.1 "Replacing the Lithium Battery".

4.3. System Expansion Capabilities

4.3.1. M.2 Interfaces

The KBox C-103-CFL is equipped with three M.2 interfaces on the KBox C-103-CFL baseboard. The M.2 interface connectors are located on the top side of the baseboard and are accessible after removing the side access cover. There are two B type interfaces, one (J18) for 2280, 2260 and 2242 modules and one (J13) for 2242/3042 and 2230/3030 modules. The M type M.2 interface (J17) supports 2280, 2260 and 2242 modules. Refer also to the subsection 6.3.7 "Installing/Removing an M.2 Module".

Refer to section 8.1 "Specifications of the internal M.2 Connectors" and the descriptions in this manual.

4.3.2. Mini PCI Express® Interface

The KBox C-103-CFL is equipped with a Mini PCIe interface on the KBox C-103-CFL baseboard. The Mini PCIe interface connector (J20) is located on the lower side of the baseboard and is not accessible in the field. This interface connector is intended to be used for Fieldbus or WiFi expansion. If a customer requires this system expansion, it must be selected when ordering, as this expansion has to be carried-out at factory.

Refer also to subsection 6.3.4.

Refer to section 13/ "Technical Specifications" and the descriptions in this manual.

4.3.3. Standard PCI Express® Interfaces

The baseboard of KBox C-103-CFL provides 1x PCIe x8 interface.

Via riser cards there are available PCI/PCIe expansion possibilities as shown in the chapter 4.5 (area marked "C").



Please observe the different configuration options regarding the PCI/PCIe cards installation, for each system variant of the KBox C-103-CFL family.
Refer to chapter 13/ "Technical Specifications" and the descriptions in this manual.

4.3.4. SATA Interfaces

The baseboard of KBox C-103-CFL provides 4 SATA interfaces. These allow the installation of up to two internal 2.5" SATA HDDs/SSDs or optional front accessible drive bays for 2.5" SATA HDDs/SSDs (refer to the subsection 4.5.11 "Internal or Removable 2.5" SATA HDDs/SSDs").



Please observe the different configuration options, regarding the installation of 2.5" SATA HDD/SSD devices, for each system of the KBox C-103-CFL family (refer to the area marked "D" in the section 4.5).
Refer to chapter 13/ "Technical Specifications" and the descriptions in this manual.

4.3.5. Internal USB 3.0 Interface

The baseboard of KBox C-103-CFL provides one USB3.0 interface (USB A header) and space for a USB A module. This connector can be used to install an internal USB device e.g. a USB Dongle.



Please observe the different configuration options, regarding the installation of 2.5" SATA HDD/SSD devices, for each system of the KBox C-103-CFL family (refer to the area marked "D" in the section 4.5).

Refer to chapter 13/ "Technical Specifications" and the descriptions in this manual.

4.3.6. Internal microSD Card and microSIM Card Interface

The baseboard of KBox C-103-CFL provides a microSD/microSIM combo interface. This allows the installation of one microSD card and one microSIM card.

For installing/removing a micro SD or microSIM card, refer to chapter 6.3.8 "Installing/Removing a microSD/microSIM Card".

Figure 4 to Figure 10: Views of a KBox C-103-CFL-2

Figure 4: Bottom side view

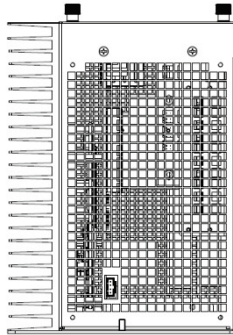


Figure 6: Front side view config. with removable drives



Figure 7: Front side view config. without removable drives



Figure 5: Right side view

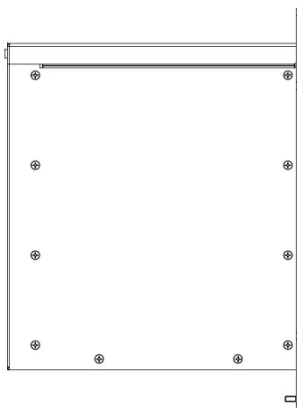


Figure 8: Left side view

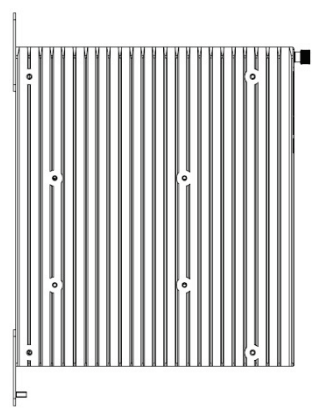


Figure 9: Top side view

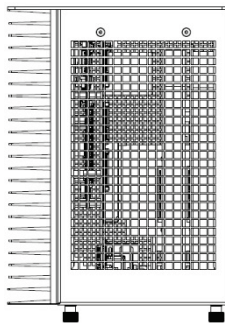
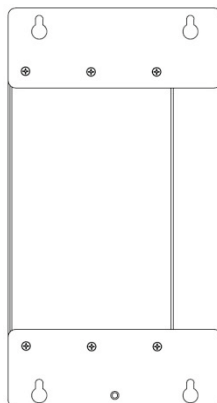
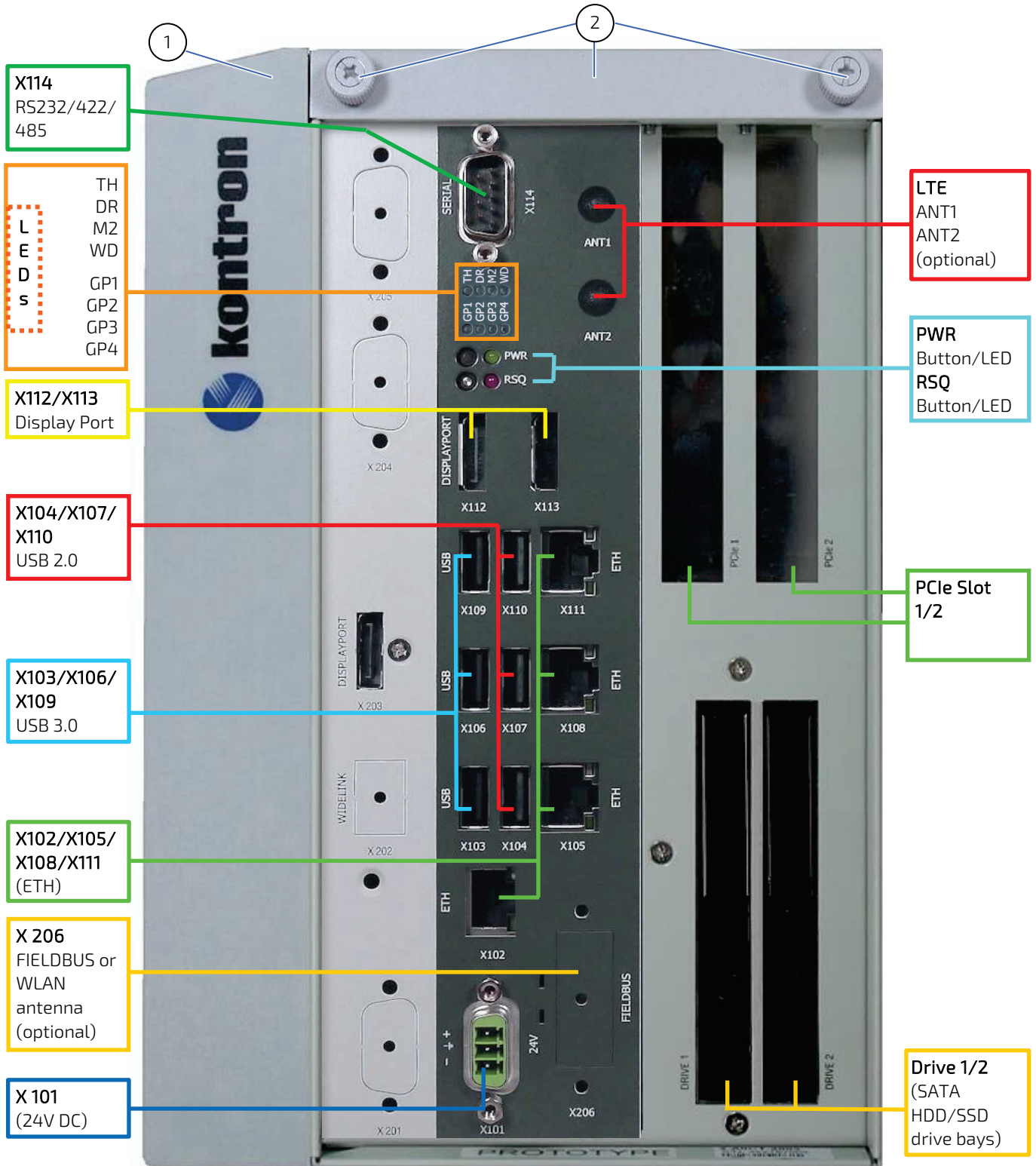


Figure 10: Rear side view



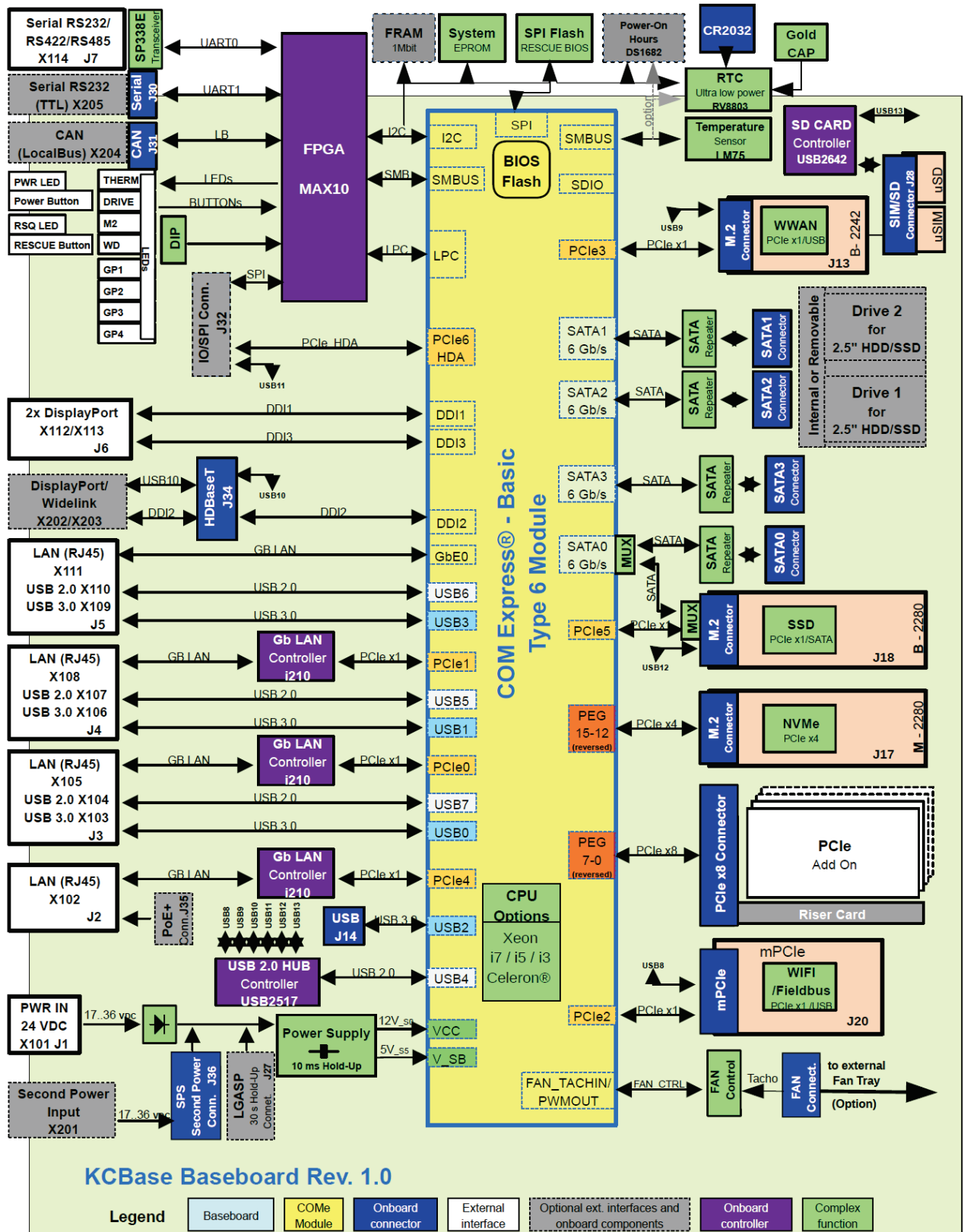
4.4. KBox C-103-CFL-2 Variant

Figure 11: KBox C-103-CFL-2 - front view (shown with removable drive bays and without mounting brackets)



1. Side of KBox C-103-CFL-2 with cooling fins
2. Top side cover with knurled screws

Figure 12: Block Diagram - KBox C-103-CFL-x

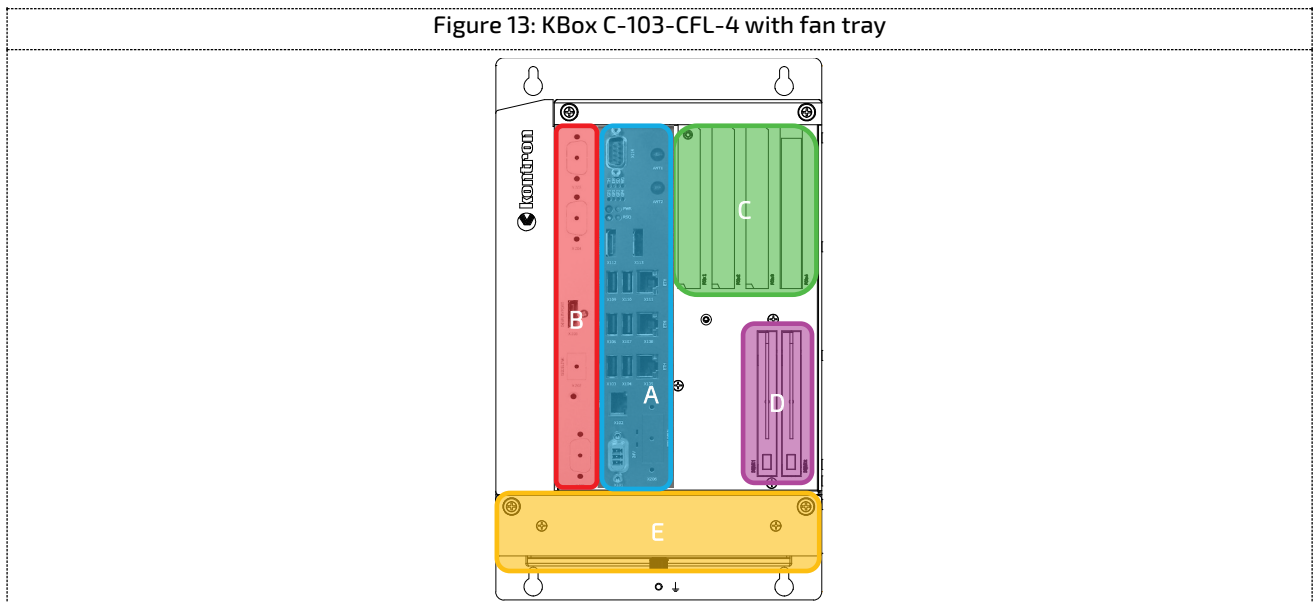


4.5. Front Side Configuration and Options - KBox C-103-CFL

Table 3: KBox C-103-CFL Front Side Configuration

A	Standard Interfaces	KBox C-103-4	KBox C-103-2	KBox C-103-1	KBox C-103-0	
	Power Input Connector (X101)	1x	1x	1x	1x	
	Ethernet (X102/X105/X108/X111)	4x	4x	4x	4x	
	USB 3.0 (X103/X106/X109)	3x	3x	3x	3x	
	USB 2.0 (X104/X107/X110)	3x	3x	3x	3x	
	DisplayPort (X112/X113)	2x	2x	2x	2x	
	RS232/422/485 (X114)	1x	1x	1x	1x	
B	Extension Capabilities (Options, factory-installed only)					
	FIELDBUS or WiFi on mPCIe (X201 or X206)	1x	1x	1x	1x	
	CAN Port (X204)	1x	1x	1x	1x	
	2 nd RS232/RS422 Port (X205)	1x	1x	1x	1x	
	WideLink (X202) or 3 rd DisplayPort (X203)	1x	1x	1x	1x	
	2 nd Power Input Connector (X201)	1x	1x	1x	1x	
	LTE on M.2 3042 (ANT1/ANT2)	1x	1x	1x	1x	
C	PCI/PCIe Expansions via corresponding Riser Cards (Options)					
	1-Slot PCIe Riser	1x PCIe x4 socket	-	-	1x	-
		1x PCIe x8 socket	-	1x	1x	-
	2-Slot PCIe Riser	2x PCIe x4 socket	-	1x	-	-
		1x PCIe x4 socket and PCI (32 bit) socket	-	1x	-	-
	4-Slot PCIe Riser	2x PCIe x4 socket and 2x PCIe x1 socket	1x	-	-	-
D	Internally/externally accessible 2.5" SATA HDD/SSD and M.2 SSD (Options)					
	<i>Either</i> Internal 2.5" SATA HDD/SSD	2x	2x	1x	1x	
	<i>OR</i> Removable Drive Bay for 2.5" SATA HDD/SSD	2x	2x	1x	-	
	M.2 2280 1x type M, 1x type B	2x	2x	2x	2x	
E	Fan Tray (Option)					
	Fan Tray	1x	1x	1x	-	

Figure 13: KBox C-103-CFL-4 with fan tray



4.5.1. X101/X201 – Power Input Connectors

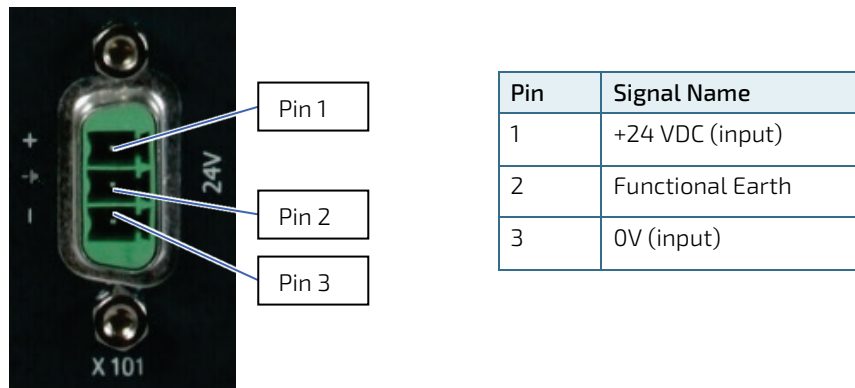
The 3-pin connector (X101) and the optional second power connector (X201) provide the power connection of the KBox C-103-CFL system to an appropriate DC main power supply (see Figure 14 and Figure 11). For pin assignment refer to the subsection 14.1.1.



If a second power supply is connected to the KBox C-103-CFL, only the particular power supply with the higher supply voltage will be used (no power sharing), the other power supply is redundant. Active and redundant power supply can change during operation without interruption.

The external cable connector is a Phoenix PSC 1,5/ 3-M, 3-pin plug with an SCT-D-SUB 9-KG housing. This power plug is delivered along with the KBox C-103-CFL. Please observe the section 9.1 "Connecting to DC Main Power Supply". The mating connector is a Phoenix PSC 1,5/ 3-F connector.

Figure 14: X101 - 24VDC power input connector



4.5.2. X102/X105/X108/X111 - Ethernet Connectors (ETH)

These connectors (X102/X105/X108/X111, Figure 11) are Gigabit Ethernet 10/100/1000 Mbit/s, IEEE 1588 capable interfaces. X102 optionally provides a PoE (Power over Ethernet) option (the PoE module has to be developed on project base). The connectors are standard 8-pin RJ45 type connectors with status LEDs:

- ▶ Activity/link: green = link up; green blinking = activity.
- ▶ Speed: off, green, yellow (10/100/1000 Mbit/s).

For pin assignment refer to subsection 14.1.2.

4.5.3. X103/X106/X109 - USB 3.0

The KBox C-103-CFL provides three USB 3.0/2.0 interfaces. These connectors (X103/X106/X109, Figure 11) allow connection of USB 3.0 or USB 2.0 compatible devices to the system. For pin assignment refer to subsection 14.1.3.

4.5.4. X104/X107/X110 - USB 2.0

The KBox C-103-CFL provides three USB 2.0/1.1 interfaces. These connectors (X104/X107/X110, Figure 11) allow connection of USB 2.0 or USB 1.1 compatible devices to the system. For pin assignment refer to subsection 14.1.4.

4.5.5. X112/X113/X203 - DisplayPorts

The KBox C-103-CFL provides DisplayPort compliant interfaces realised using two (optional: three) standard DisplayPort connectors. External (digital) displays can be connected to the DisplayPort connectors (X112/X113, optional: X203, Figure 11).

For pin assignment refer to subsection 14.1.5.

4.5.6. X114 - RS232/422/485 Port

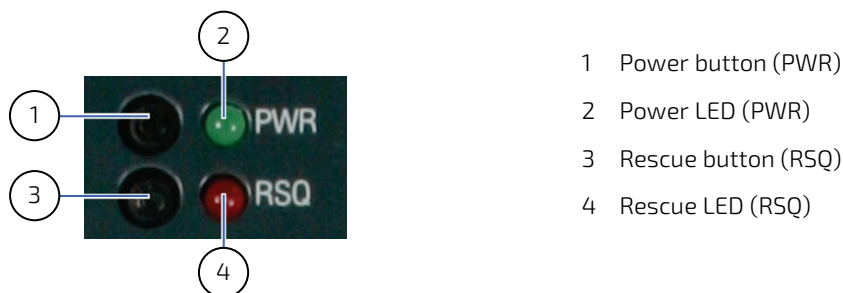
The RS232/422/485 interface (X114, Figure 11) is provided as a 9-pin D-SUB connector. It allows you to connect a serial device to the system. A special feature of this port is that it also can be configured as dual RS422/485 port.

No special OS driver/SW is needed. For configuration refer to chapter 11/ "uEFI BIOS".

For pin assignment refer to subsection 14.1.6.

4.5.7. POWER Button and PWR LED

Figure 15: Detail - Power button and PWR LED/Rescue button and RSQ LED



The power button (PWR, Figure 15, pos. 1, Figure 11) is used to power the KBox C-103-CFL on or off.

By pressing the power button for longer than four seconds a forced system shutdown will be initiated, before the power to the system is turned off.

NOTICE

Caution: Performing a forced shut down can lead to loss of data or other undesirable effects!

The power LED (marked PWR, Figure 15, pos. 2, Figure 11) is on green steady when power is applied to the system.

Prerequisite:

The KBox C-103-CFL has to be connected to an appropriate main power supply (DC).

WARNING

Even when the system is turned off via the power button there are parts of the system still energized.

The unit is only completely disconnected from the DC mains, when the power is removed.

As soon as external power is applied to the main input power connector X101 (Figure 14) or to the optional second power connector X201 (Figure 11), the KBox C-103-CFL boots up and then starts the operating system and application where available.

To perform an orderly shutdown of the system, press the PWR button and the system shuts down under the control of the operating system.

Once the system has been shut down, it can be restarted by pressing the PWR button (assuming that power is still applied to the main input power connector, X101).

4.5.8. RESCUE Button and RSQ LED



The rescue function is not intended for use with a system in an application environment. It is designed to be used if the standard BIOS flash is corrupted, in order to get the system to boot in a defined and safe state for further failure resolution.

Please refer to the chapter 12/ "KBox C-103-CFL CPLD Specific Registers".

The RESCUE button (marked RSQ, Figure 15, pos. 3, Figure 11) is used to force using the backup flash for system booting.

The RESCUE LED (RSQ, Figure 11, Figure 15, pos. 4) blinks red when the backup flash is selected for booting. The backup flash contains a cloned BIOS (uEFI) version. In the event the system does not properly start-up or gets hung-up and restarting (cold booting) the system does not help, it is possible to switch to the backup boot flash and then restart the system. To do this, press the RSQ button for more than five seconds, whether or not the system is running it will now start-up using the backup flash for booting.

To revert to using the standard boot flash, the system must be cold started, or remove power completely from the system and then reapply.

4.5.9. Status and General Purpose LEDs

After power is applied and the KBox C-103-CFL performs the boot procedure, the LEDs show the POST code. In case of a boot failure within the uEFI the last post code is displayed. When the boot phase is passed without errors, the LEDs change to their status and general purpose function.

The following table provides information concerning these LEDs (Figure 11 and Figure 16).

Figure 16: Detail - Status and General Purpose LEDs

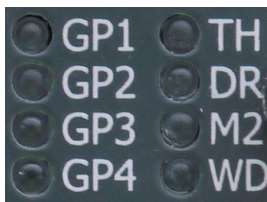


Table 4: Status and General Purpose LEDs

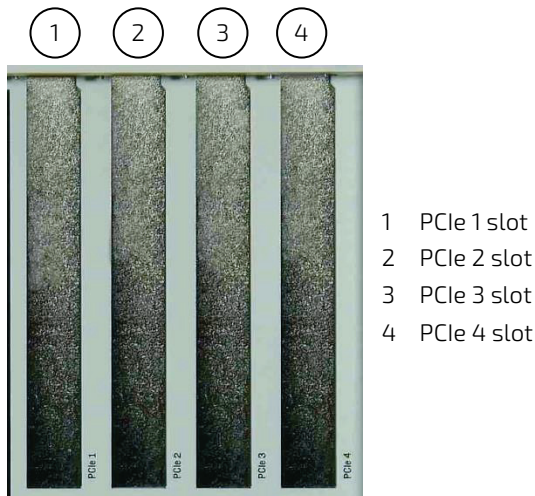
Status and General Purpose LEDs				
Designator	Function	Color	Description	Post Code
TH	Thermal	Green	Normal operation	Bit #7 MSB
		Red blinking	The system turns off due to over temperature	
DR	Drives (SSD/HDD)	Green	SSD/HDD active	Bit #6
M2	M.2 2242 Card	Green	M.2 card active	Bit #5
WD	Watchdog	Red blinking	Watchdog timeout occurred	Bit #4
GP1	General Purpose 1	Red/Green/Orange	User general purpose 1	Bit #3
GP2	General Purpose 2	Red/Green/Orange	User general purpose 2	Bit #2
GP3	General Purpose 3	Red/Green/Orange	User general purpose 3	Bit #1
GP4	General Purpose 4	Red/Green/Orange	User general purpose 4	Bit #0 LSB

4.5.10. PCI/PCIe Expansion Slots

The KBox C-103-CFL provides on the front side up to four slots (see also Figure 11 for KBox C-103-CFL-2) for system expansion with PCI/PCIe expansion cards via corresponding riser cards.

To access the corresponding riser card sockets, in order to install or remove PCI/PCIe expansion cards (refer to the subsection 6.3.5 "Riser Cards Expansion Sockets for PCI/PCIe Cards"), you have to remove the top side access cover. For a better accessibility of the expansion sockets you should also remove the right side access cover (Figure 23 and Figure 21, pos. 1 and pos. 3).

Figure 17: PCIe 1 to PCIe 4 slots (shown as detail of a KBox C-103-CFL-4)



Please observe that:

KBox C-103-CFL-4 supports up to:

- ▶ 2x PCIe x4 and 2x PCIe x1 expansion cards

KBox C-103-CFL-2 supports up to:

- ▶ 2x PCIe x4 expansion cards **or**
- ▶ 1x PCIe x8 expansion cards **or**
- ▶ 1x PCIe x4 and 1x PCI (32 bit) expansion cards.



KBox C-103-CFL-1 supports:

- ▶ 1x PCIe x4 expansion card **or**
- ▶ 1x PCIe x8 expansion card

KBox C-103-CFL-0:

- ▶ Can't be equipped with PCI/PCIe expansion cards.

For system configuration refer to the area marked "C" in the section 4.5. and for expansion card installation refer to the subsection 6.3.6 "Installing/Removing PCI/PCIe Expansion Cards".

4.5.11. Internal or Removable 2.5" SATA HDDs/SSDs

Depending on the ordered system configuration, your KBox C-103-CFL-2 can be equipped with up to two drive bays for 2.5" removable SATA HDDs/SSDs (refer to Figure 11, Figure 12) or one internal mounting frame for 2x 2.5" SATA HDDs/SSDs. The drive bays are suitable for 9.5 mm SSDs and 7 mm SSDs (with adapter).

The internal 2.5" HDDs/SSDs are not accessible from the outside. The internal SATA HDDs/SSDs are installed (always factory installed) into the system by use of a mounting frame.

The 2.5" drive bays (DRIVE 1 and DRIVE 2) for removable HDDs/SSDs are accessible from the front side (Figure 11) of the system (refer to Figure 18, Figure 19 and Figure 20).

The drives support following drive speeds:

- ▶ DRIVE 1: up to SATA 6 Gb/s.
- ▶ DRIVE 2: up to SATA 6 Gb/s.



If the KBox C-103-CFL-2 configuration with internal 2.5" SATA HDDs/SSDs was ordered, the "DRIVE 1" and "DRIVE 2" for removable SATA HDDs/SSDs are not available (refer to Figure 7). If the KBox C-103-CFL-2 configuration with removable 2.5" SATA HDDs/SSDs was ordered, no installation of any internal SATA HDD/SSD (with mounting frame) is possible. Refer also to the area marked "D" in the section 4.5.

Figure 18: Drive 1 and Drive 2 for removable 2.5" SATA HDD/SSD (option); closed drive bays



Figure 19: Drive bay 1 with opened drive bay cover

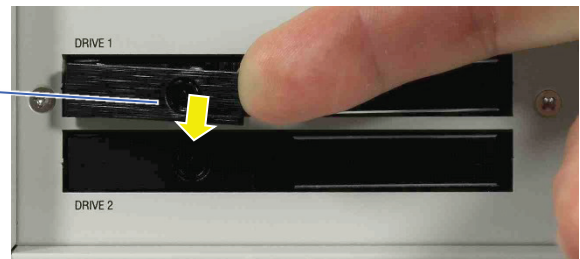
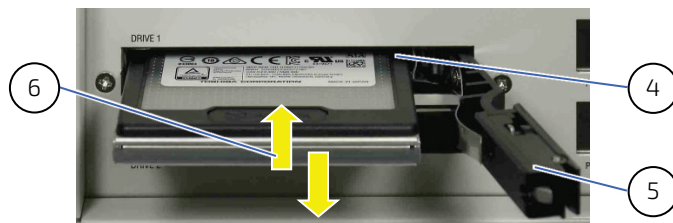


Figure 20: Inserting/removing a 2.5" removable SSD



This SATA interface supports hot-swapping. To prevent data loss, don't remove the HDD during read/write activity [while the "DRIVE LED" (Figure 16) is flashing green].

- | | |
|---|--|
| <ul style="list-style-type: none"> 1 Lockable lever to release the drive bay cover 2 Cover of the drive bay 3 Pulled-out lever | <ul style="list-style-type: none"> 4 Drive bay for 2.5" removable SATA HDD/SSD 5 Opened drive bay cover 6 Inserting or removing a 2.5" removable SATA HDD/SSD |
|---|--|



Please observe that the KBox C-103-CFL-1 system configuration can be equipped with only one internal or removable 2.5" SATA HDD/SSD. The KBox C-103-CFL-0 can be equipped with only one internal 2.5" SATA HDD/SSD. Refer also to the area marked "D" in the section 4.5.

4.5.11.1. Installing/Removing the removable HDD/SSD

To install/remove a removable drive, please perform the following steps:

1. Pull out the lever (Figure 19, pos. 3) of the drive cover (Figure 18, pos. 2) and release it. (If required, unlock the lever with the corresponding key before.)
2. The drive bay cover will spring open and the removable drive will automatically slide out a bit.
3. Insert/remove the drive into/out from the bay receptacle.
4. Close the cover.

4.6. Left and Right Side View

Figure 21: Right side of the KBox C-103-CFL system

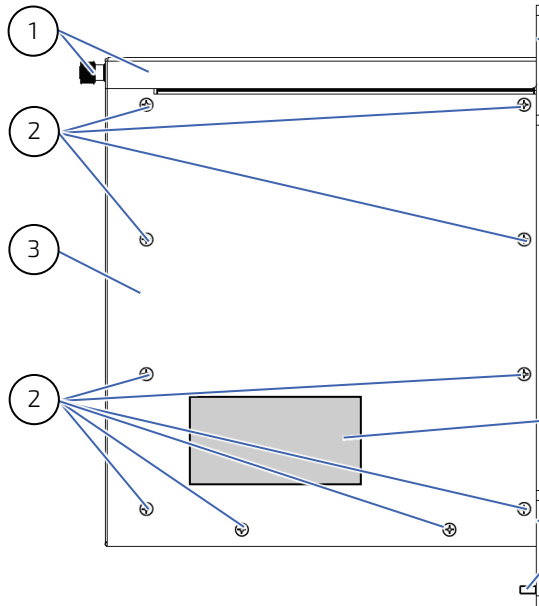
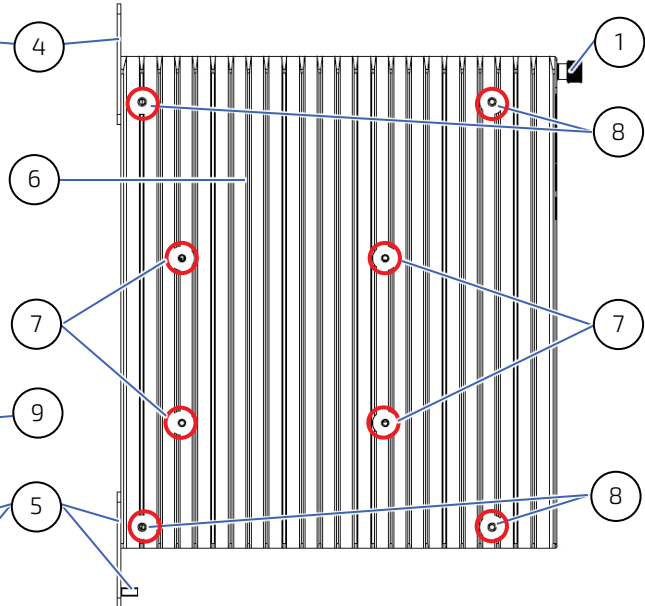


Figure 22: Left side of the KBox C-103-CFL system



- 1 Top side access cover with knurled screws
- 2 10x screws that secure the right side access cover
- 3 Right side access cover
- 4 Upper mounting bracket with key holes
- 5 Lower mounting bracket with M4 ground stud and key holes
- 6 Cooling fins of the chassis

- 7 Screws that secure the COMExpress® module
- 8 Screws that secure the cooling fins to the chassis
- 9 Type label
- 10 Hole for further system fan tray extension
- 11 Air intake openings on the bottom cover
- 12 Air exhaust openings on the top cover

NOTICE

Please do not remove the red marked screws (see Figure 22, pos. 7 and pos. 8).

4.7. Top and Bottom Side View

Figure 23: Top side of the KBox C-103-CFL system

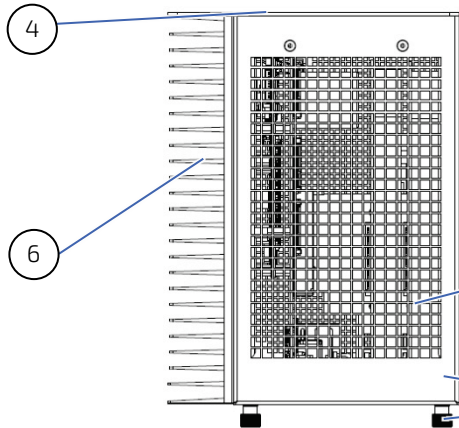
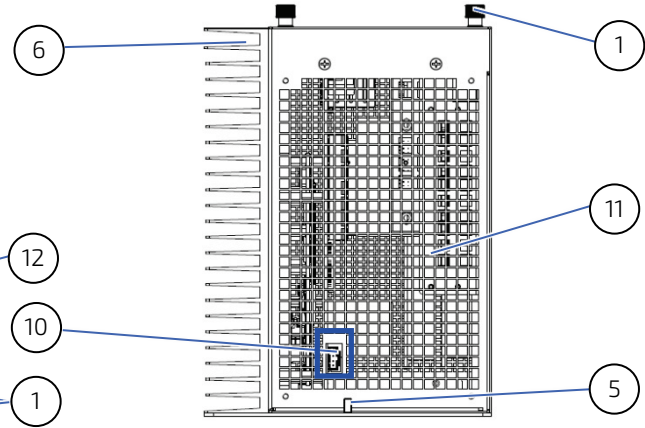


Figure 24: Bottom side of the KBox C-103-CFL system



NOTICE

When powering on the KBox C-103-CFL, make sure that the air intake and exhaust openings are not obstructed. To provide sufficient heat dissipation for the cooling of the KBox C-103-CFL system, never cover the cooling fins of the chassis. Do not place any objects onto the device.

4.8. Rear Side View

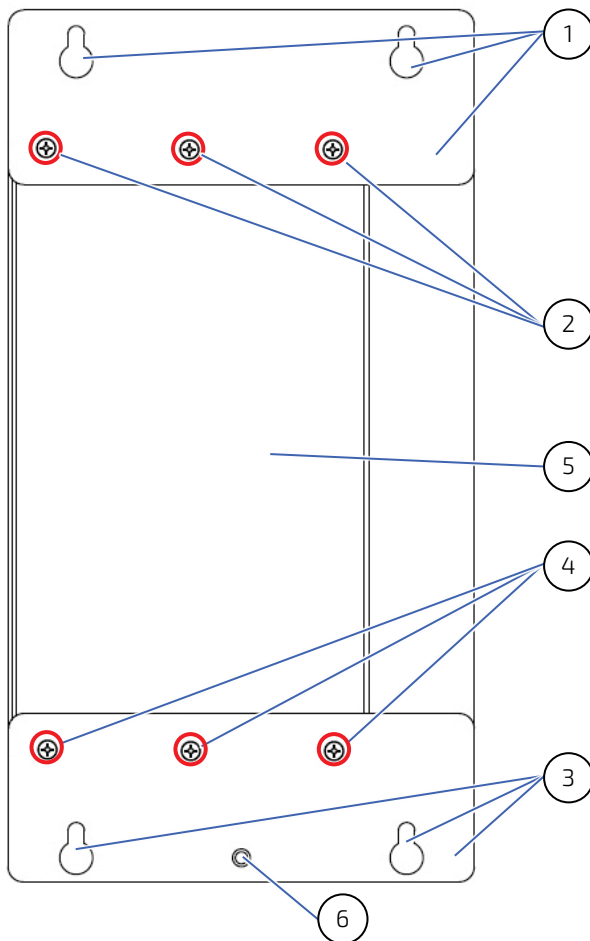
The KBox C-103-CFL is designed for wall mounting, in vertical position inside of a control cabinet.



Please do not remove the red marked screws (see Figure 25, pos. 2 and pos. 4).

Please observe the mounting instructions included in the chapter 8/ "Installation Instructions", and the outline dimensions in the subsection 13.1 "Mechanical Specifications of the KBox C-103-CFL".

Figure 25: Rear side of the KBox C-103-CFL-2 system



- 1 Key holes on the upper mounting bracket
- 2 Screws that secure the upper mounting bracket of the KBox C-103-CFL-2 and KBox C-103-CFL-1 (KBox C-103-CFL-0 has only 2 screws)
- 3 Key holes on the lower mounting bracket
- 4 Screws that secure the lower mounting bracket of the KBox C-103-CFL-2 and KBox C-103-CFL-1 (KBox C-103-CFL-0 has only 2 screws)
- 5 Chassis rear
- 6 Functional Earth stud

4.9. Functional Earth Stud

There is an M4 functional earth terminal on the lower mounting bracket of the KBox C-103-CFL (Figure 25, pos. 6). This terminal may be connected as required.

NOTICE

The KBox C-103-CFL with the stud marked with a "Functional Earth" symbol (Figure 25) has to be grounded to an appropriate "common earth" connection point.

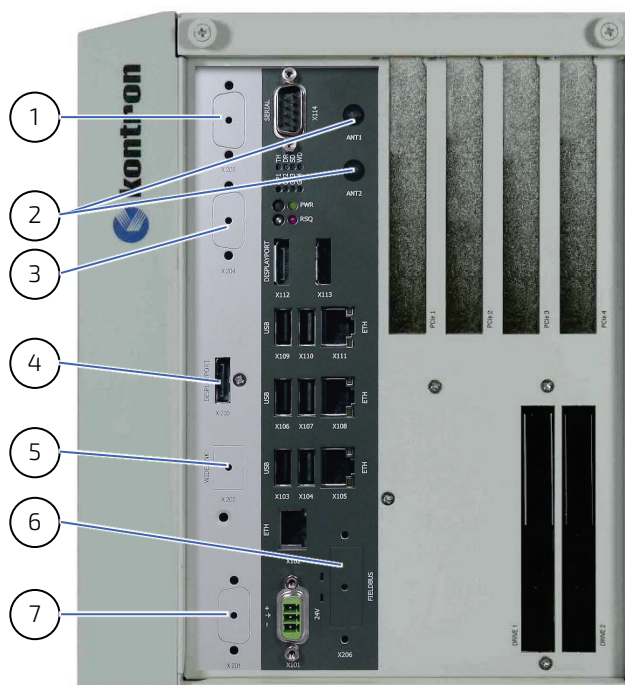
5/ System Extensions

Optionally your KBox C-103-CFL can be equipped by factory only, with following ports and additional components:

- ▶ Serial port RS232 or RS422 via an adapter module
- ▶ CAN port: via an adapter module
- ▶ DisplayPort: via corresponding adapter module
- ▶ WideLink Port: via corresponding adapter module
- ▶ Fan Tray: an additional component connected to the KBox C-103-CFL-4, KBox C-103-CFL-2 and KBox C-103-CFL-1
- ▶ Fieldbus: (Profibus, Profinet or Ethercat): via internal factory mounted adapter module
- ▶ Second 24 VDC input (X201)
- ▶ GPIO module
- ▶ WIFI module
- ▶ LTE module

You have to order these components separately, in order to extend your KBox C-103-CFL at the factory.
Example of system configuration, see below:

Figure 26: KBox C-103-CFL-4 shown with optional interfaces and with removable drive bays



- 1 Serial port RS232/RS42 (X205)
- 2 2x antenna for LTE M.2 module
- 3 CAN port (X204)
- 4 DisplayPort (X203)
- or*
- 5 Widelink port (X202)
- 6 Fieldbus (ProfiNet etc.), dual RJ45 (X206) (depending on the ordered option)
- or*
- 2x WiFi antennas for mPCIe module
- 7 2nd 24 VDC input connector (X201)
- or*
- Fieldbus (ProfiBus etc.) on D-Sub 9 (depending on the ordered option)

5.1. X201 to X206 - Possible Interface Combinations

The matrix below provides an overview of the possible interface combinations (X201 to X206).

Table 5: X201 to X206 Configuration Options

		2nd Power Input	Profibus	WideLink	3rd DP port	CAN	2nd Serial	Profinet/Ethercat	WiFi
		X201	X201	X202	X203	X204	X205	X206	X206
2nd Power Input	X201	-	No	Yes	Yes	Yes	Yes	Yes	Yes
Profibus	X201	No	-	Yes	Yes	Yes	Yes	No	No
WideLink	X202	Yes	Yes	-	No	Yes	Yes	Yes	Yes
3rd DP port	X203	Yes	Yes	No	-	Yes	Yes	Yes	Yes
CAN	X204	Yes	Yes	Yes	Yes	-	Yes	Yes	Yes
2nd Serial	X205	Yes	Yes	Yes	Yes	Yes	-	Yes	Yes
Profinet/Ethercat	X206	Yes	No	Yes	Yes	Yes	Yes	-	No
WiFi	X206	Yes	No	Yes	Yes	Yes	Yes	No	-

5.2. (X205) - Serial Port RS232/RS422



This port can be only factory installed and configured.

When you order the KBox C-103-CFL with this extended interface via RS232/422 adapter module, you have to specify in your ordering:

- ▶ the needed configuration of this port as RS232 or RS422 and
- ▶ for RS422 configuration: if the onboard termination resistor (120Ω) should be enabled or disabled.

Your KBox C-103-CFL can be extended, via an adapter module, with an additional serial interface RS232/RS422. This serial port (Figure 26, pos. 1) is available as 9-pin D-SUB connector (male), marked as "SERIAL" on the front side of the system. It must be factory configured as RS232 or RS422 corresponding your ordered port configuration. The serial port will be configured via an on-board DIP switch (SW1) for RS232 or RS422 serial communication. This port is galvanically isolated (500V).

Your system order with RS422 port must also contain the specification about the termination resistor (120Ω). If your application requires the termination resistor, it must be enabled at factory only. For pin assignment refer to subsection 14.2.4.

5.3. LTE M.2 module

The KBox C-103-CFL can optionally be equipped with cellular technology LTE (4G) to meet GCF or PTCRB. Please request this option if required. The antennas will be routed to ANT1/ANT 2 (Figure 26, pos.2).

5.4. (X204) - CAN Port

Your KBox C-103-CFL can be extended via an adapter module with one CAN port (SJA1000 implementation), that allows layer 2 CAN communication. The optional CAN port (Figure 26, pos. 3) is implemented as a sub-D 9 pin connector (male). This port is galvanically isolated (1500V).

For pin assignment refer to the section 14.2.5.



If a termination resistor (120Ω) is required, you have to make a connection (bridge) between pin 1 and 2, respectively pin 7 and pin 8, in order to enable the onboard termination resistor (120Ω).

5.5. (X203) - 3rd DisplayPort

Your KBox C-103-CFL can optionally be extended with a third DisplayPort (Figure 26, pos. 4).

The DP 3 port is a DisplayPort compliant interface realized using a standard DisplayPort connector. An external (digital) display can be connected to the DisplayPort connector (Figure 26, pos. 4).

For pin assignment refer to subsection 14.1.5.

5.6. (X202) - WideLink Port

WideLink is an extension for the KBox C-103-CFL which implements a HDBaseT 2.0 transmitter for video and USB 2.0 signals. The HDBaseT standard can be used to extend the distance between a computer and a monitor of up to 150 meters, depending on the resolution and the cable quality. HDBaseT is also known as IEEE1911.

For pin assignment refer to subsection 14.2.2.



Only one of these two interfaces (WideLink and DP 3) can be ordered as optional extension of your KBox C-103-CFL system.

5.7. (X201 or X206) Fieldbus or WiFi

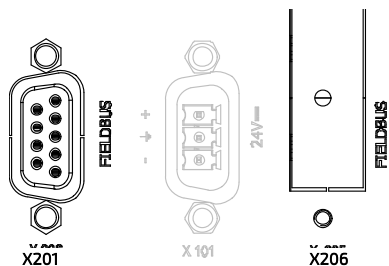
5.7.1. Fieldbus

Your KBox C-103-CFL can optionally be extended with a module for Fieldbus communication. Either a module for Profibus or Profinet/Ethercat communication will be integrated. Depending on the Fieldbus chosen, the DSUB brake-out (X201) for Profibus or the dual RJ45 brake-out (X206) for Profinet/Ethercat will be used.



Only one of these two Fieldbus interfaces (D-Sub or dual RJ45) can be ordered as optional extension of your KBox C-103-CFL system.

Figure 27: X201 or X206 – Locations for the optional FIELDBUS interface



The optional interface (FIELDBUS) on the front side of the KBox C-103 must be ordered separately either as D-Sub (X201) or as dual RJ45 (X206) connector. To add a FIELDBUS interface to the system, the mPCIe socket (on the lower side of the baseboard), will be used. This connection can be implemented at factory only.

5.7.2. WiFi/BT

To add a WiFi/BT functionality to the system, the mPCIe socket (on the bottom of the baseboard), will be used. This connection can be implemented at factory only. The WiFi antennas will use the brake-out X206.

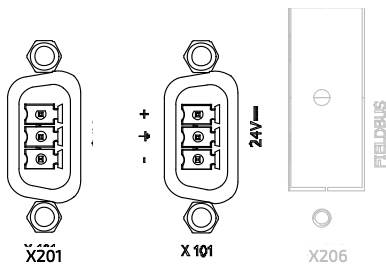
Table 6: WiFi/BT Expansion Card Option

Expansion slot	Description
1x WiFi mPCIe (half-size)	Dual band frequencies (2.4 GHz & 5 GHz) Bluetooth (BT) 4.1+HS IEEE802.11 ac/abgn Wi-Fi certified Speeds 300 Mbps max. on N & 867 Mbps on AC

5.8. (X201) 2nd 24 VDC Input

Your KBox C-103-CFL can optionally be extended with a second power input module (X201). Both power connectors have the same pinout. The power source with the highest input voltage will be used to power the system (hot standby).

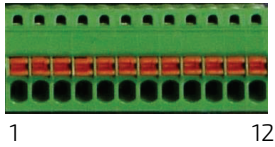
Figure 28: Second power input (X201)



5.9. 8-Channel GPIO/DIO Interface

The KBox C-103-CFL provides an optional 8-channel GPIO/DIO (Digital IO) interface.

Figure 29: GPIO connector (cable terminal side of mating connector)



This connector contains the eight GPIOs, the power supply for the GPIOs and GND.

Table 7: GPIO connector pinout

Pin	Signal Name	Direction	Remark
1	PWR_IN	Power	Power Input for the GPIO
2	PWR_IN	Power	
3	Not Connected	n.c.	-
4	GPIO1	In / Out	GPIO
5	GPIO2	In / Out	
6	GPIO3	In / Out	
7	GPIO4	In / Out	
8	GPIO5	In / Out	
9	GPIO6	In / Out	
10	GPIO7	In / Out	
11	GPIO8	In / Out	
12	GND	Ground	GND GND is direct connected to system chassis (Shield)

Table 8: GPIO misc. specifications

Interfaces	
Output Drivers	Texas instruments TPS4H000-Q1
USB	CDC Interface to CPU board
MISC	
Power Supply for GPIOs	Input voltage range: 10V* to 30V* *Note: Power input fused with 3A
Hot-Plug Support	NO

Eight GPIOs are implemented. Each GPIO can be select as an output or an input channel.

Table 9: GPIO output channel

Output Channel	
Output Type	High Side Switch
Output Voltage	Depends on External Connected Voltage. Allowed Range: 10VDC to 30VDC.
Output Current	250mA Continues Electrical limited to about 500mA.
Inductive load switch-off energy dissipation	40mJ
Output Protection	- Short-to-GND Protection by Current Limit - Thermal Shutdown with Output auto-retry - Inductive Load Negative Voltage Clamp

Figure 30: Output application connected to GPIO

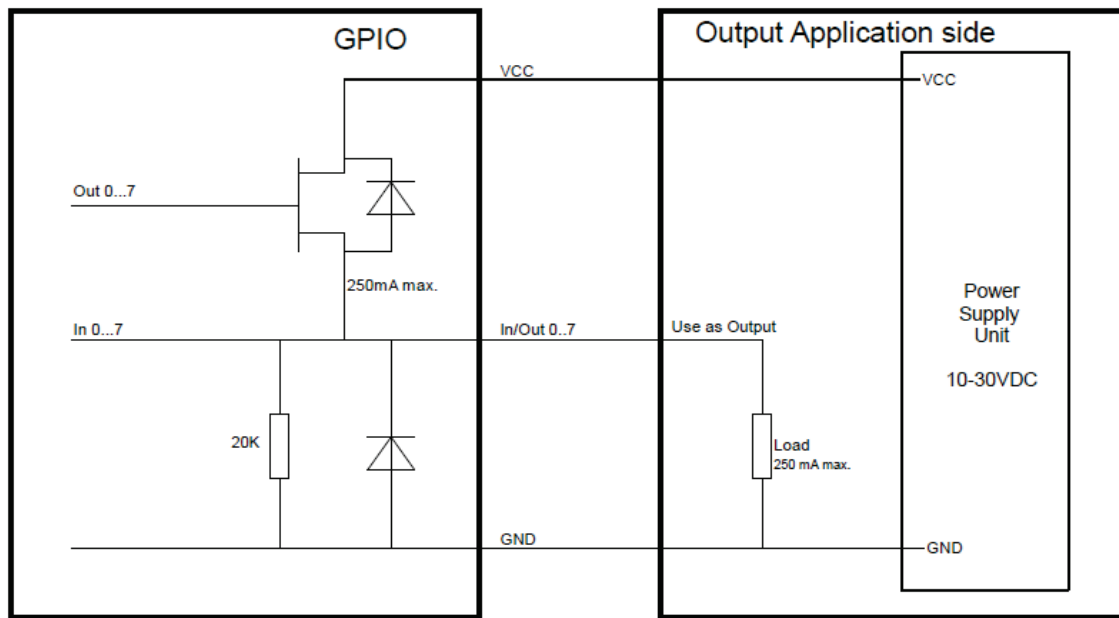


Table 10: GPIO input channel

Input Channel	
Input Type	Input with Integrated Pulldown
Max. Input Voltage	Maximum Allowed Input Voltage Depends on External Connected Voltage at PWR_IN. (GPIO _x ≤ PWR_IN) Allowed Range: 10 VDC to 30 VDC.
Input Pulldown Resistor	~ 20 kOhm
Input High Level	> 8.8 V
Input Low Level	< 4.2 V
Input Hysteresis	> 2.5 V

Figure 31: Input application connected to GPIO

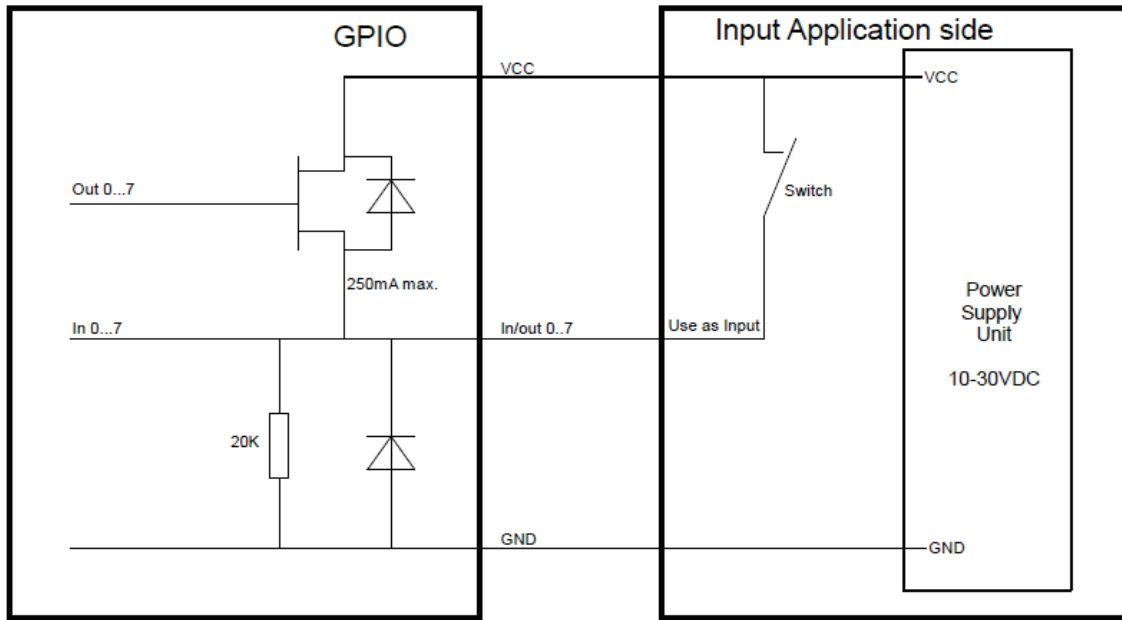


Table 11: GPIO connector and mating connector

	Manufacturer	P/N	Mating Cycles	Remark
Connector	Würth Elektronik or equivalent	691382040012 WR-TBL Serie 382 or equivalent	25	12-pin, 2.50 mm Horizontal PCB Header with Flanges Max. 12 A per pin
Mating Connector	Würth Elektronik or equivalent	691381030012 WR-TBL Serie 381 or equivalent	25	12-pin 2.50 mm Vertical CAB Entry Plug Screw less with Flanges (STRANDED WIRE: 24-16 AWG / 0.205-1.31 MM ²)

5.10. Optional Versions with Fan Tray - KBox C-103-CFL-4/-2/-1

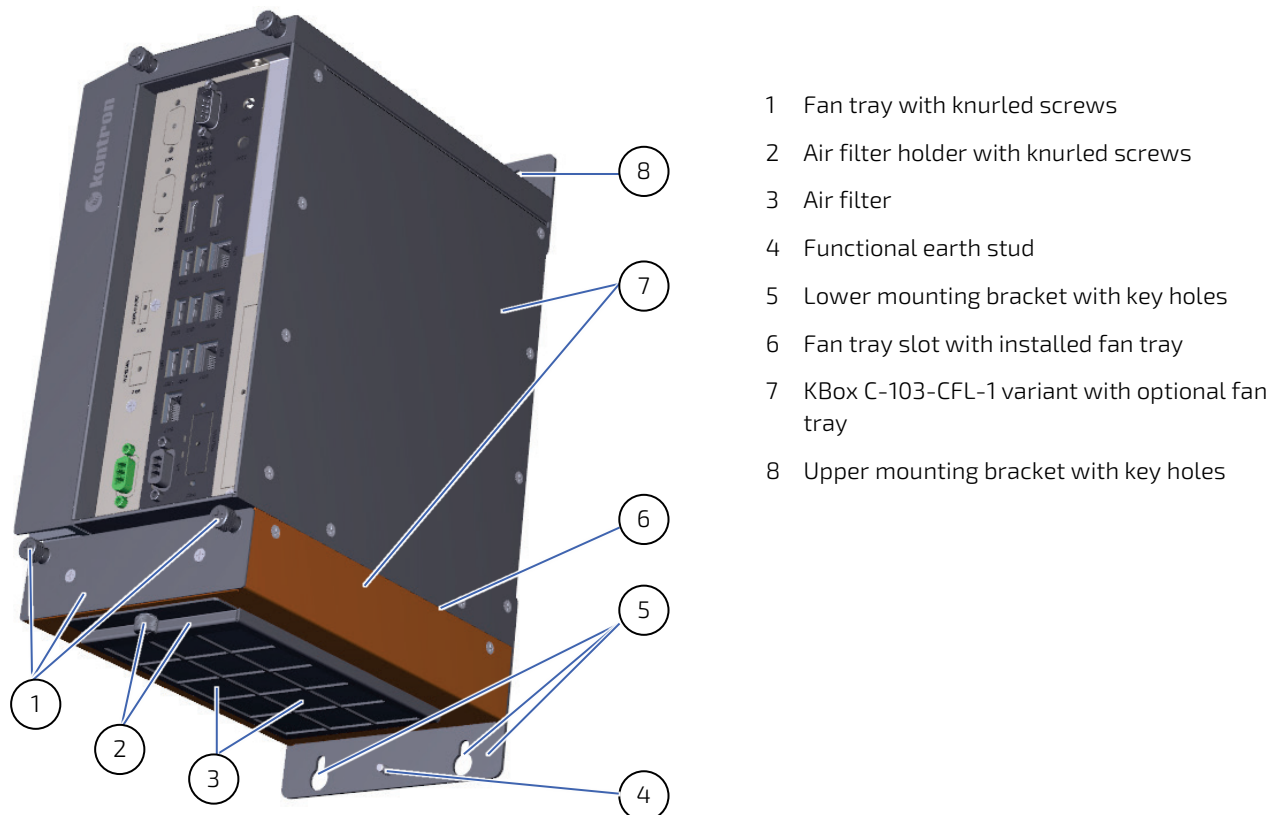
By using a fan tray, the KBox C-103-CFL-4/-2/-1 can be operated in a control cabinet with extended ambient temperature; refer to the specified values in the section 13.2 "Environmental Specifications and chapter 7/ "Power and Thermal Considerations".



All chapters of this manual are valid for the KBox C-103-CFL-4, the KBox C-103-CFL-2 and KBox C-103-CFL-1 with fan tray under consideration of the mechanical differences and the description in this section. Please refer also to the subsection 13.1.2 "Mechanical Specifications of the KBox C-103-CFL-4 with Fan Tray Option", subsection 13.1.4 "Mechanical Specifications of the KBox C-103-CFL-2 with Fan Tray Option", and subsection 13.1.6 "Mechanical Specifications of the KBox C-103-CFL-1 with Fan Tray Option".

The KBox C-103-CFL with fan tray chassis extension is designed to provide a better airflow through the system chassis. The KBox C-103-CFL-4/-2/-1 can be only factory equipped with the optional fan tray (Figure 32). The fan tray slot is external mounted to the bottom side of the KBox C-103-CFL-4/-2/-1 chassis and comprises a fan tray (Figure 32, pos. 1) with one fan as well as the air filter.

Figure 32: KBox C-103-CFL-1 equipped with the optional fan tray



- 1 Fan tray with knurled screws
- 2 Air filter holder with knurled screws
- 3 Air filter
- 4 Functional earth stud
- 5 Lower mounting bracket with key holes
- 6 Fan tray slot with installed fan tray
- 7 KBox C-103-CFL-1 variant with optional fan tray
- 8 Upper mounting bracket with key holes

The fan is integrated in a user-friendly, replaceable fan tray (hot-swapping). The fan tray is designed to be inserted into the fan tray slot (Figure 32, pos. 6) on the bottom side of the KBox C-103-CFL-4/-2/-1. The fan tray simplifies the installation and removal of this component, even during operation.

The fan rotation speed is temperature controlled in dependence on the CPU temperature. Thus, a reliable air circulation for optimal active cooling of the KBox C-103-CFL-4/-2/-1 is ensured.

The temperature conditions of the system (depending on the environmental temperature and the system load) are detected by the CPU temperature sensor.

In order to ensure a clean air circulation through the system, the fan tray slot provides an installed air filter (Figure 32, pos. 3).

The air filter, which protects your system against dust and dirt, is washable and may be replaced during operation; refer to subsection 10.4 "Cleaning the Air Filter".

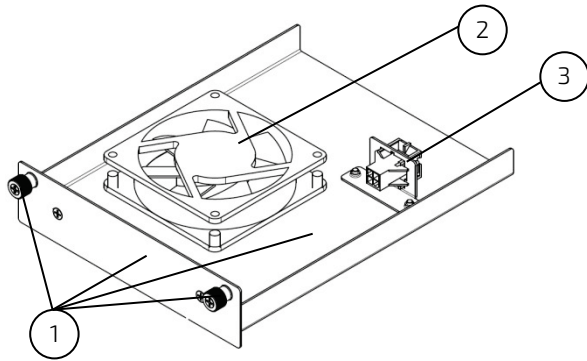
5.10.1. Fan Tray (only for KBox C-103-CFL-4/-2/-1)

CAUTION

The fan tray can be replaced during operation. This should only be carried-out by qualified personnel, aware of the associated dangers (see subsection 10.3 "Replacing the Fan Tray").

Figure 33: Fan tray components of the KBox C-103-CFL-4/-2/-1

Cable connections between fan and fan connector are included in this assembly.



- 1 Fan tray with knurled screws
- 2 Fan (temperature controlled)
- 3 Connector for fan power and control

6/ Accessing Internal Components

This chapter contains important information that you must read before accessing the internal components. You must follow these procedures properly when installing, removing or handling any system component.

It is recommended to expand your system with additional PCI/PCIe/M.2 cards before it is installed into an industrial control cabinet. Please consider following instructions when you install or remove expansion cards.

Before installing/removing an expansion card, please pay attention to the following information:

⚠ WARNING

Please observe the "General Safety Instructions for IT-Equipment" provided with the system (refer also to the chapter 1/) and the installation instructions contained in this manual. The KBox C-103-CFL system shall be mounted into a control cabinet.

Only personnel with appropriate qualifications, trainings and authorization are permitted to install and work with the KBox C-103-CFL system.

The installation/removal of HDDs/SSDs and/or expansion cards may only be performed by a qualified person, according to the description in this manual.

Before removing the cover of the device, make sure that the device is powered off and disconnected from the power supply.

Before you upgrade the KBox C-103-CFL with expansion cards, pay attention to the power specifications in chapter 13/ "Technical Specifications" and make sure that the power consumption of the expansion cards does not exceed 15 W per card.



Please follow the safety instructions for components that are sensitive to electrostatic discharge (ESD). Failure to observe this warning notice may result in damage to the device or/and internal components.



Please pay attention to the manufacturer's instructions before installing/removing an expansion card.

6.1. Top Cover



The pictures in this section correspond to a KBox C-103-CFL-2 system.

The cover description can be applied to all system variants, under consideration of the different mechanical specifications of the KBox C-103-CFL; refer to the section 13.1 "Mechanical Specifications of the KBox C-103-CFL".

WARNING

When used as intended the KBox C-103-CFL is to be operated only in closed condition. Only when the right side cover is fixed with the screws (Figure 21, pos. 2) and top cover is properly installed and secured with the knurled screws (Figure 11, pos. 2) on the front side, it is ensured that the user doesn't have access to the internal components of the KBox C-103-CFL during operation.

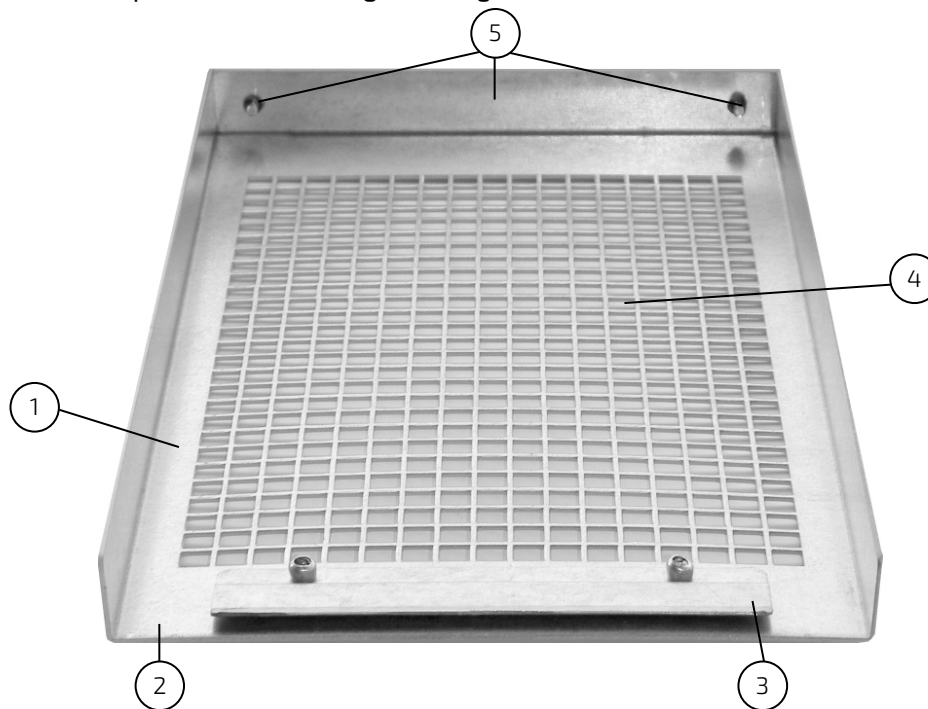
The cover will be fixed to the chassis using the centring bracket at the rear side of the cover (Figure 34, pos. 3) and the fixing bracket with captive knurled screws at the front side of the cover (Figure 34, pos. 5).

When inserting the cover, make sure that:

- ▶ At the rear: the centring bracket (Figure 34, pos. 3) is inserted properly into the corresponding cover retaining bracket of the chassis (Figure 39, pos. 13).
- ▶ At the front side: the fixing bracket with captive knurled screws of the cover (Figure 34, pos. 5), is matching properly over the cover retaining bracket on the front side (Figure 39, pos. 1).

The fixing bracket with captive knurled screws (Figure 34, pos. 5) secures the top cover on the front side (Figure 11, pos. 2).

Figure 34: Inside of the top cover with centering and fixing brackets



- | | |
|------------------------------|--|
| 1 Inside of the top cover | 3 Centering bracket (on the rear side) |
| 2 Rear part of the top cover | 4 Air exhaust openings |
| | 5 Fixing bracket with knurled screws on the front side |

6.2. Opening and Closing the KBox C-103-CFL



The pictures in this section correspond to a KBox C-103-CFL-2 system.

The "opening/closing" procedure description can be applied to all system variants, under consideration of the different mechanical specifications of the KBox C-103-CFL; refer to the section 13.1 "Mechanical Specifications of the KBox C-103-CFL".

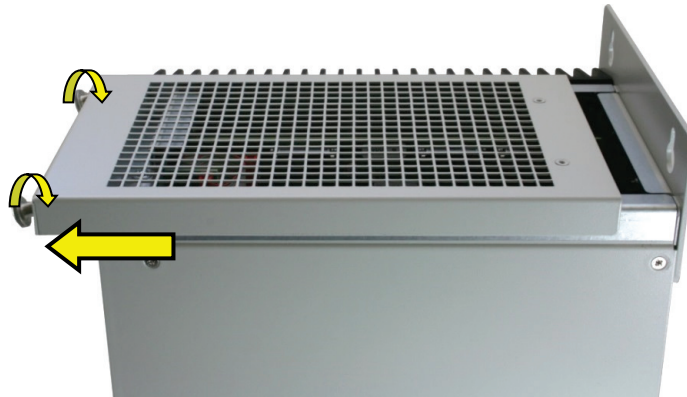
For opening/closing the KBox C-103-CFL, please perform the following steps:

WARNING

The system must be powered off and disconnected from the main power supply, before you attempt to open the KBox C-103-CFL. Ensure that you have a clean, flat and ESD-safe surface to work on. Also disconnect all peripheral devices from the KBox C-103-CFL. Please observe the instructions contained in the chapter 8/ "Installation Instructions".

1. Close all applications. Shut down the system properly and disconnect the connection to the power source. Disconnect all peripherals.
2. The KBox C-103-CFL should lay on a flat, clean surface with the top side facing upwards.
3. Loosen the knurled screws, which secure the top cover on the front of the system (see Figure 11 and Figure 35).
4. Pull the cover out a little bit, as shown in Figure 35, to release the cover centering and fixing brackets.

Figure 35: Removing the centering and fixing bracket of the top cover (detail of the KBox C-103-CFL-2)

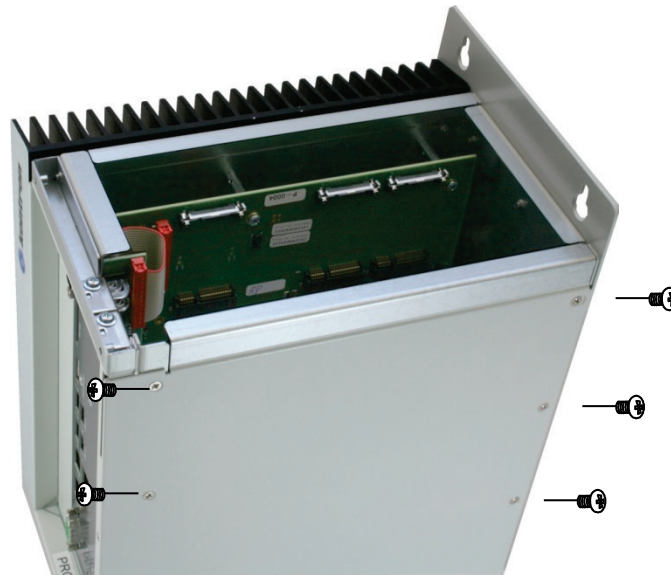


5. Lift the top cover up (on the front edge) and remove it (Figure 36). Now you have access to the internal sockets (PCI/PCIe/M.2) or to the corresponding cards/devices, in order to install or remove internal hardware components.

Figure 36: Removing the cover (detail of the KBox C-103-CFL-2)

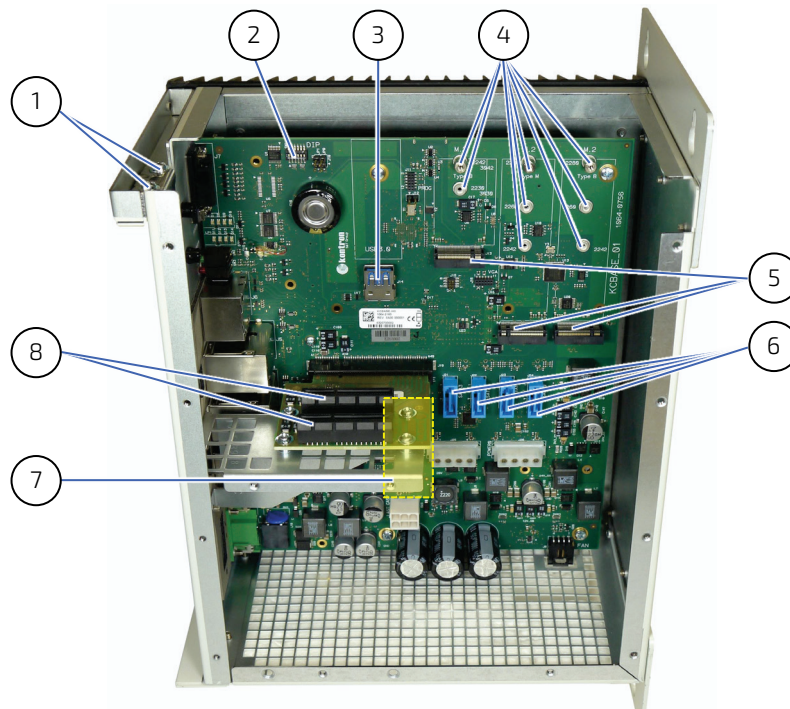


Figure 37: KBox C-103-CFL-2 - removing the right side cover



6. For a better accessibility of the internal sockets (PCI/PCIe and M.2 modules), you may also remove the right side cover of the KBox C-103-CFL (Figure 37). Loosen the externally accessible fastening screws (Figure 21, pos. 2) that secure the right side cover (Figure 37 and Figure 21, pos. 3). Pull the right side cover out, to detach it from the sideways mounted bolts. Put the right side cover and the screws aside for later use.

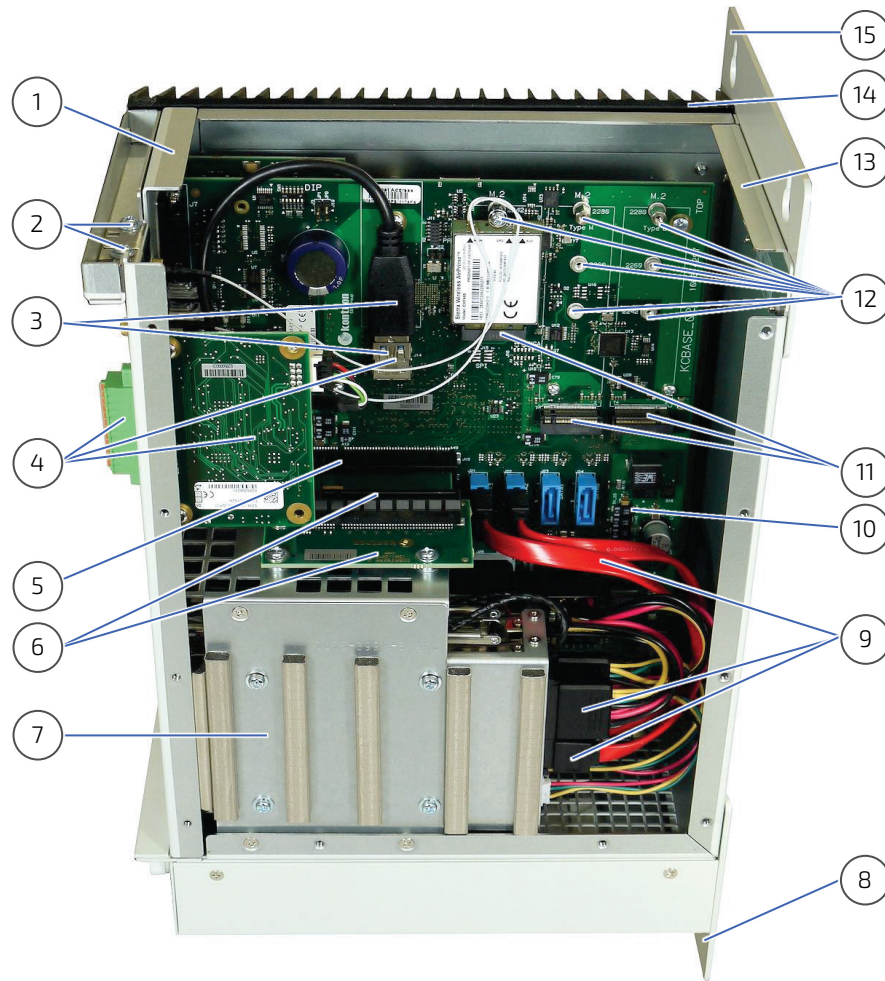
Figure 38: KBox C-103-CFL-2 without top and right side cover (shown with a PCIe riser card)



- | | |
|--|---|
| <ol style="list-style-type: none"> 1 Screws to fix the PCIe slot bracket or the I/O bracket of the PCIe card 2 DIP switch 3 Internal USB 3.0 port with space for module 4 Threaded holes/fixing bolts to secure the 3x M.2 modules | <ol style="list-style-type: none"> 5 3x M.2 sockets (2x Type B, 1x Type M; from left to right: J13, J17, J18) 6 4x SATA connectors 7 1x Mini PCIe socket for PCIe Mini card (J20) <i>(not visible; obstructed by riser card)</i> 8 Riser card with 2x PCIe x4 sockets |
|--|---|

6.3. Internal View

Figure 39: KBox C-103-CFL-2 - internal view (shown with a PCIe riser card and removable HDD/SSD drive bay)



- | | |
|---|---|
| 1 Cover retaining bracket on the front side | 9 SATA cable connections (power and data) |
| 2 Screws that secure the PCIe slot brackets | 10 Baseboard |
| 3 Internal USB 3.0 port with USB cable connected | 11 3x M.2 sockets (2x Type B, 1x Type M),
left socket (J13) with wireless module installed |
| 4 Optional GPIO module, connected to
internal USB 3.0 port via cable | 12 Threaded holes/fixing bolts to secure the 3x M.2
modules |
| 5 PCI x8 socket of the baseboard | 13 Cover retaining bracket on the rear side |
| 6 Riser card with 1x PCIe x8 socket | 14 Cooling fins |
| 7 Mounting frame for 2.5" drive bays of the
removable HDDs/SSDs | 15 Upper mounting bracket with key holes |
| 8 Lower mounting bracket with key holes | |

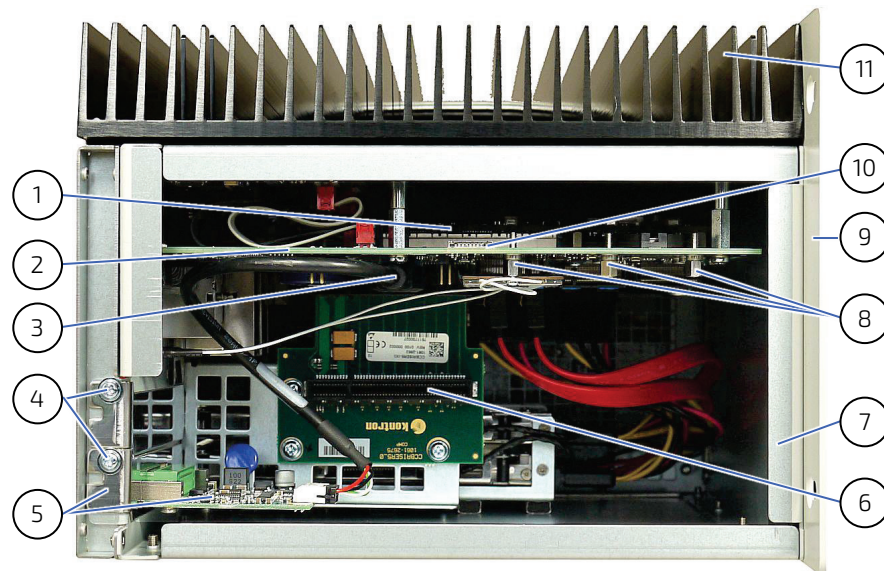


The Mini PCIe socket is on the lower side of the baseboard and can be only at factory equipped with an expansion card.

6.3.1. Integrated COMe Module

Depending on the ordered system configuration, your KBox C-103-CFL accommodates a baseboard with a COMe-bCL6 module.

Figure 40: KBox C-103-2 - internal view with COMExpress® module and with PCIe riser card



- | | |
|--|--|
| 1 COM Express module | 6 Riser card with 1x PCIe x8 socket |
| 2 Baseboard | 7 Cover retaining plate on the rear side |
| 3 Internal USB 3.0 port with USB cable connected | 8 Threaded holes/fixing bolts to secure the 3x M.2 modules |
| 4 Screws that secure the PCIe slot brackets | 9 Upper mounting bracket with key holes |
| 5 Slot bracket with optional GPIO module (not connected to the riser card) | 10 microSD/microSIM combo connector |
| | 11 Cooling fins |



Refer to the information and technical data included in the user manual of the installed COMe-bCL6 module.

The user manual of the installed COMe Module can be downloaded from our web page www.kontron.com. Search for the name of the installed module.

6.3.2. M.2 Sockets

Depending on the system configuration ordered your KBox C-103-CFL can be extended with up to three M.2 modules. For installation/removing of the M.2 SSD refer to the subsection 6.3.7 "Installing/Removing an M.2 Module".

6.3.3. DIP Switch

The baseboard of the KBox C-103.CFL is equipped with an DIP switch (Figure 38, pos. 2). The particular DIP switches have the following functions:

- ▶ DIP switch 1-4: User defined
- ▶ DIP switch 5: BIOS Auto setting for Riser card (OFF = 1x X8 / ON = 2x X4)
- ▶ DIP switch 6: ON: Fan tray present (therm LED behavior change, green → amber)

6.3.4. Expansion Socket for PCIe Mini Cards

Depending on the system configuration ordered, your KBox C-103-CFL can be extended with a PCIe Mini card.



The KBox C-103-CFL provides one internal Mini PCIe socket for PCIe Mini cards. The Mini PCIe socket is on the lower side of the baseboard and can be only at factory equipped with an expansion card.

6.3.5. Riser Cards Expansion Sockets for PCI/PCIe Cards

Depending on the system configuration ordered, your KBox C-103-CFL can be extended with 1x PCI (32 bit) card and up to four PCIe x4/PCIe x1 cards (full-height, half-length form factor) via corresponding riser cards.

For installation/removing of PCI/PCIe cards into/from the corresponding socket

(Figure 42, pos. 5 and pos. 6, Figure 43, pos. 5 and pos. 8), please refer to the subsection 6.3.6 "Installing/Removing PCI/PCIe Expansion Cards".



To expand your system with expansion cards, please observe the power consumption specified in chapter 13/ "Technical Specifications".
The power consumption of each expansion card does not exceed 15 W.



Please observe that:

KBox C-103-CFL-4 supports up to:

- ▶ 2x PCIe x4 and 2x PCIe x1 expansion cards

KBox C-103-CFL-2 supports up to:

- ▶ 2x PCIe x4 expansion cards **or**
- ▶ 1x PCIe x8 expansion cards **or**
- ▶ 1x PCIe x4 and 1x PCI (32 bit) expansion cards.

KBox C-103-CFL-1 supports:

- ▶ 1x PCIe x4 expansion card **or**
- ▶ 1x PCIe x8 expansion card

KBox C-103-CFL-0:

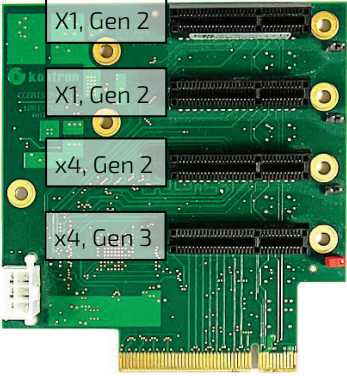
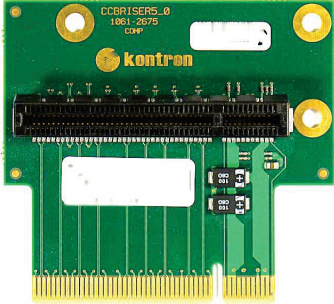
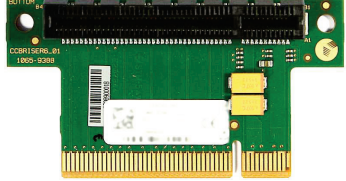

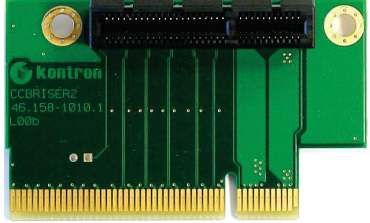
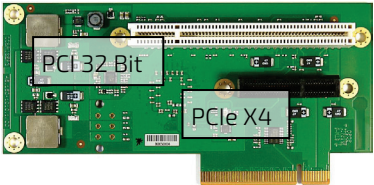
- ▶ Can't be equipped with PCI/PCIe expansion cards.

For system configuration refer to the area marked "C" in the section 4.5. and for expansion card installation refer to the subsection 6.3.6 "Installing/Removing PCI/PCIe Expansion Cards".

6.3.5.1. Riser Cards for KBox C-103-CFL-x

Depending on the variant and system configuration ordered, your KBox C-103-CFL-x can be equipped with different riser cards. The following table shows which riser card is available for which system.

Table 12: Available Riser Cards for the different KBox C-103-CFL variants

KBox C-103-CFL-4	KBox C-103-CFL-2	KBox C-103-CFL-1
<ul style="list-style-type: none"> ▶ 2x PCIe x4 (1x Gen 3, 1x Gen 2) ▶ 2x PCIe x1 (2x Gen 2) ▶ 4x "Card present" jumper ▶ Extra power connector 	<ul style="list-style-type: none"> ▶ 1x PCIe x8 	<ul style="list-style-type: none"> ▶ 1x PCIe x8 
	or	or
	<ul style="list-style-type: none"> ▶ 2x PCIe x4 ▶ 2x "Card present" jumper 	<ul style="list-style-type: none"> ▶ 1x PCIe x4 
	or	
	<ul style="list-style-type: none"> ▶ 1x PCI 32 Bit ▶ 1x PCIe x4 	

NOTICE

Info on this PEG Port setting (see also Table 23, PEG Width Configuration):
 [1x8+2x4 rev] is used with 2 Slot and 4 Slot PCIe Risercards
 [2x8 rev] is used with the 1 Slot X8 PCIe Risercards.

6.3.5.2. Detail: Riser Card for KBox C-103-CFL-4

The KBox C-103-CFL-4 is equipped with a riser card that supports 2x PCIe x4 (1x Gen 3, 1x Gen 2) and 2x PCIe x1 (2x Gen2) expansion cards (full-height, half-length form factor). The riser card provides an extra power connector for add-on cards with high power consumption and a "card present" jumper for each slot. If an installed add-on card is not automatically detected by the system, set the corresponding jumper to switch the status to "card present".

Figure 41: Riser card with 2xPCIe x4 and 2x PCIe x1 slots for KBox C-103-4



6.3.6. Installing/Removing PCI/PCIe Expansion Cards (KBox C-103-CFL-4/-2/-1 only)

The PCI/PCIe expansion cards can be installed into the slots on the front side of the system (Figure 11). The slots are marked with "PCIe 1" to "PCIe 4". It is recommended to expand your KBox C-103-CFL with PCI/PCIe cards before it is installed into a control cabinet.

1. Close all applications; shut down the system properly and disconnect the connection to the power source. Disconnect all peripherals.
2. To have access to the PCI/PCIe sockets you have to open the KBox C-103-CFL-4/-2/-1 as described in the section 6.2 "Opening and Closing the KBox C-103-CFL" (step 1-6).
3. To remove/install an expansion card, you have to remove the corresponding card/slot bracket (refer to Figure 11 and Figure 42/Figure 43). Loosen the corresponding fastening screw on the internal side, which secures the slot/card bracket and remove it. Retain the screw for later use (refer to Figure 42/Figure 43, pos. 2).

Figure 42: Detail of the KBox C-103-CFL-2 with PCIe riser card with 2x PCIe x4 sockets

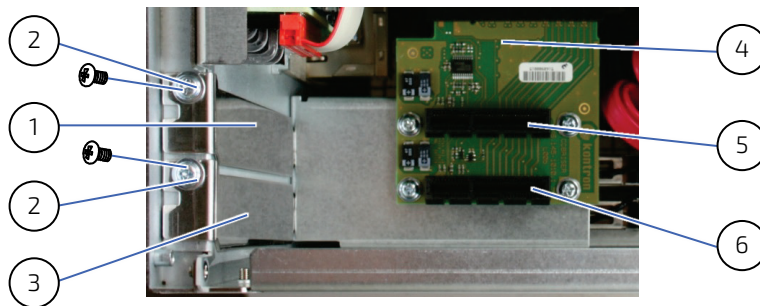


Figure 43: Detail of the KBox C-103-CFL-2 with PCI-PCIe riser card with 1x PCI (32 bit) and 1x PCIe x4 sockets

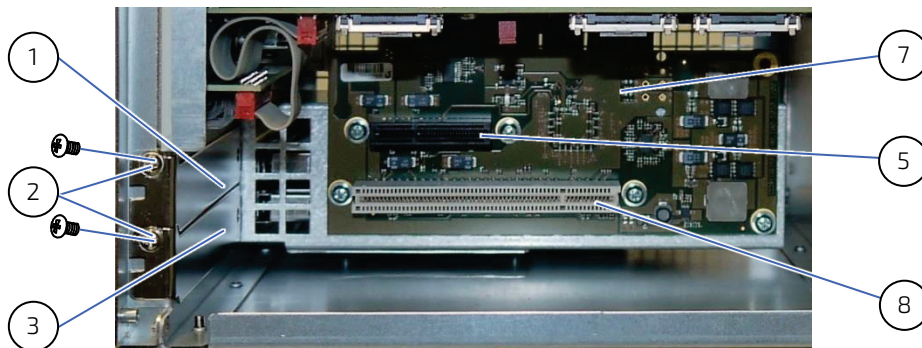
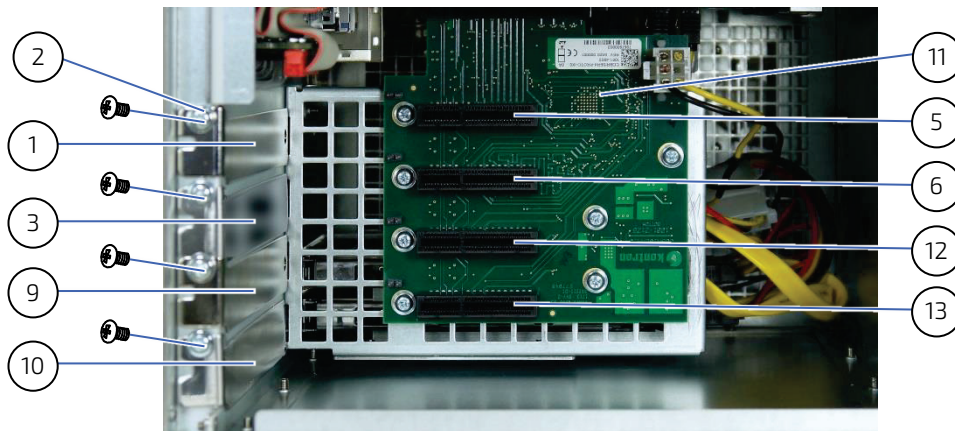


Figure 44: Detail of the KBox C-103-CFL-4 with PCIe riser card with 2x PCIe x4 and 2x PCIe x1 sockets



Legend for Figure 42, Figure 43 and Figure 44 :

- | | |
|---|--|
| 1 Slot bracket for the for the PCIe 1 expansion slot | 8 Free 1x PCI (32 bit) (for PCIe 2 slot) |
| 2 Screws to secure the expansion slot/cards brackets | 9 Slot bracket for the for the PCIe 3 expansion slot |
| 3 Slot bracket for the for the PCIe 2 expansion slot | 10 Slot bracket for the for the PCIe 4 expansion slot |
| 4 Riser card with 2x PCIe x4 expansion sockets | 11 Riser card with 2x PCIe x4 and 2x PCIe x1 expansion sockets |
| 5 Free PCIe x4 socket (for PCIe 1 slot) | 12 Free PCIe x1 socket (for PCIe 3 slot) |
| 6 Free PCIe x4 socket (for PCIe 2 slot) | 13 Free PCIe x1 socket (for PCIe 4 slot) |
| 7 Riser card with 1x PCI and 1x PCIe x4 expansion sockets | |
-
4. Insert/remove the expansion card into/from the corresponding PCI/PCIe socket of the corresponding riser card (Figure 42, pos. 5, pos. 6 or Figure 43, pos. 5, pos. 8).
 5. If you have removed an expansion card, re-insert the slot bracket.
 6. Secure the card or slot bracket to the chassis with the retained fastening screw.
 7. In order to close the KBox C-103-CFL, proceed in reverse order (step 6 to 1 in the section 6.2 "Opening and Closing the KBox C-103-CFL").

6.3.7. Installing/Removing an M.2 Module

To install an M.2 module please proceed according to the steps described:

1. Close all applications; shut down the system properly and disconnect the connection to the power source. Disconnect all peripherals.
2. Open the device as described in the subsection 6.2 "Opening and Closing the KBox C-103-CFL" (step 1-6).
3. Locate the M.2 sockets and the corresponding fixing bolts. (Figure 38, pos. 4 and 5).
4. Mount the fixing bolts at the correct position for the length of the M.2 card, using the threaded holes (Figure 38, pos. 4)
5. Insert the M.2 card into the corresponding socket (Figure 38, pos. 7) at an angle of approx. 45° and push it down until it lies on the the fixing clip.
6. Secure the M.2 on the fixing bolt with the corresponding fixing screw.
7. In order to close the KBox C-103-CFL, proceed in reverse order (step 6 to 1 of the section 6.2 "Opening and Closing the KBox C-103-CFL").

To remove an M.2 module, please proceed according to the steps described:

1. Close all applications; shut down the system properly and disconnect the connection to the power source. Disconnect all peripherals.
2. Open the device as described in the subsection 6.2 "Opening and Closing the KBox C-103-CFL" (step 1-6).
3. Locate the M.2 card installed into your system.
4. Remove the fixing screw in order to release the M.2 card. It will spring up at an angle of approx. 45° on the fixing clips side.
5. Gently pull the M.2 card out.
6. In order to close the KBox C-103-CFL, proceed in reverse order (step 6 to 1 of the section 6.2 "Opening and Closing the KBox C-103-CFL").



Preventive Maintenance for M.2 SSDs:

Because of the limited predetermined lifespan of SSDs, we recommend to check the condition of your installed SSD drives via S.M.A.R.T. regularly.

Pay attention to the manufacturer specifications for lifespan.

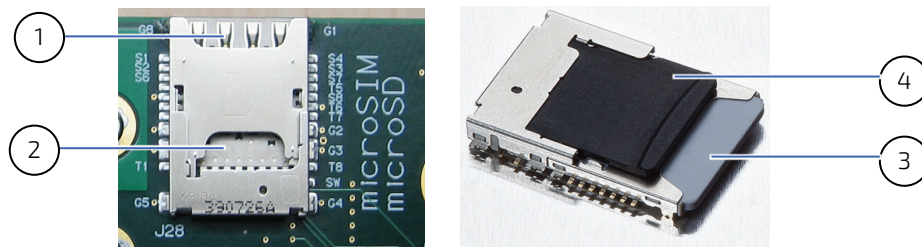
See also section 8.1 "Specifications of the internal M.2 Connectors".

6.3.8. Installing/Removing a microSD/microSIM Card

To install a microSD or a microSIM card, please proceed according to the steps described:

1. Close all applications; shut down the system properly and disconnect the connection to the power source. Disconnect all peripherals.
2. Open the device as described in the subsection 6.2 "Opening and Closing the KBox C-103-CFL" (step 1-6).
3. Locate the microSD/microSIM combo connector at the rear side of the baseboard (see also Figure 40, pos. 10).

Figure 45: microSD/microSIM combo connector



1 microSIM connector

2 microSD connector

3 inserted micro SIM card

4 inserted microSD card

4. Insert a microSIM card into the the microSIM connector or/and insert a microSD card int the microSD connector by gently pushing the card into the corresponding connector, card contacts facing down (see Figure 45).
5. In order to close the KBox C-103-CFL, proceed in reverse order (step 6 to 1 of the section 6.2 "Opening and Closing the KBox C-103-CFL").

To remove a microSD or a microSIM card, please proceed according to the steps described:

1. Close all applications; shut down the system properly and disconnect the connection to the power source. Disconnect all peripherals.
2. Open the device as described in the subsection 6.2 "Opening and Closing the KBox C-103-CFL" (step 1-6).
3. Locate the microSD/microSIM combo connector at the rear side of the baseboard (see also Figure 40, pos. 10).
4. Gently pull the microSD/microSIM card out.
5. In order to close the KBox C-103-CFL, proceed in reverse order (step 6 to 1 of the section 6.2 "Opening and Closing the KBox C-103-CFL").

7/ Power and Thermal Considerations

7.1. System Power Portfolio

Below information gives more insight on the power portfolio of KBOX C-103-CFL:

- ▶ Overall Maximum Power Consumption: **140 Watt**
- ▶ Input Voltage Nominal 24 VDC / 6 A (+20% / -20%)
- ▶ Maximum range, not considered for safety approval: 17 - 36 VDC
- ▶ Holdup Time 10ms @ 100 Watt

Please find in below tables values to calculate the total needed power for the 24 Volt power supply depending on the application. Be aware that the DC power supply must be able to handle peak currents for several seconds.

Table 13: Power Consumption

Power Consumption	COMe	Carrier	USB 3.0	USB 2.0	M.2	MiniPCIe	Sata SSD	PCIe card
CPU	TDP		4 Conn.	3 Conn.	3 Slots	1 Slot	2 Pcs.	4 Slot
Intel® Celeron™ G4930E	15W	5 W	0-20 W	0-7.5 W	0-17 W	0-4 W	0-10 W	0-50 W
Intel® Core™ i3-9100HL	25 W	5 W	0-20 W	0-7.5 W	0-17 W	0-4 W	0-10 W	0-50 W
Intel® Core™ i5-8400H	45 W	5 W	0-20 W	0-7.5 W	0-17 W	0-4 W	0-10 W	0-50 W
Intel® Core™ i7-9850HE	45 W	5 W	0-20 W	0-7.5 W	0-17 W	0-4 W	0-10 W	0-50 W
Intel® XEON™ E-2276ME	45 W	5 W	0-20 W	0-7.5 W	0-17 W	0-4 W	0-10 W	0-50 W

Table 14: Current and voltage provided in the KBOX C-103-CFL per port

	USB 3.0	USB 2.0	M.2	MiniPCIe	Sata SSD
Maximum defined Power per Port	5 W	2.5 W	5.6 W	4 W	5 W
Max current (Voltage) per Port	1 A (5 V)	0.5 A (5 V)	1.7 A (3.3 V)	1 A (3.3 V)	1 A (5 V)
				375 mA (1.5 V)	1 A (12 V)

Table 15: Maximum Power supplied on the PCIe Slots (depending on the installed PCIe expansion card)

PCIe Expansioncard	Slot1	Slot 2	Slot 3	Slot 4		12 Volt	3.3 Volt
1 Slot PCIe X8	25 W	-	-	-		2 A	3 A
1 Slot PCIe X4	25 W	-	-	-		2 A	3 A
2 Slot PCIe X4	15 W	15 W	-	-		2 A total	3 A total
4 Slot PCIe X4	15 W	15 W	10 W	10 W		4 A total	7 A total

For more information about available riser cards see also table 12.

7.2. Tuning CPU Power and Performance

There are BIOS settings that can help to limit the power consumption, peak current and thermal heat dissipation.

NOTICE

Changing these settings will influence the performance of the application.

- ▶ Turbo Mode: Will limit the CPU to the nominal TDP
Advanced/Power & Performance /CPU- Power Management Control/Turbo Mode
- ▶ Power Limits: PL1, PL2 and Tau can be set in
Advanced/Power & Performance/CPU-Power Management Control/Config TDP Configurations

Table 16: Default values in BIOS for KBOX C-103-CFL

CPU	Nominal TDP PL1 (Base)	Maximum TDP PL2 (up)	Tau Sec.	cTDP (down)
Intel® Celeron™ G4930E	15 W	15 W	-	-
Intel® Core™ i3-9100HL	25 W	31 W	-	-
Intel® Core™ i5-8400H	45 W	78 W	28	35 W
Intel® Core™ i7-9850HE	45 W	90 W	28	35 W
Intel® XEON™ E-2276ME	45 W	90 W	28	35 W

7.3. Available Processors

Table 17: Overview of some of the features of the used CPU versions in KBOX C-103-CFL

CPU	Core/Thread	Nom. Freq	Turbo Freq.	Graphics GPU
Intel® Celeron™ G4930E	2/2	2.4 GHz	-	UHD 610
Intel® Core™ i3-9100HL	4/4	1.6 GHz	2.9 GHz	UHD 630
Intel® Core™ i5-8400H	4/8	2.5 GHz	4.2 GHz	UHD 630
Intel® Core™ i7-9850HE	6/12	2.7 GHz	4.4 GHz	UHD 630
Intel® XEON™ E-2276ME	6/12	2.8 GHz	4.5 GHz	UHD P630

7.4. Convection Cooling

The KBox C-103-CFL is designed for convection cooling within the specified ambient air temperature ranges. Therefore it is imperative that air flow to and from the unit is guaranteed.

In addition, implementers must empirically verify the cooling concept for the KBox C-103-CFL including optionally installed devices prior implementing the unit in the intended application.

7.5. Active Cooling via the optional Fan Tray

For applications where convection cooling is not sufficient, there is the possibility to use the optional fan tray (externally mounted to the KBox C-103-CFL-4/-2/-1). The optional fan tray extension allows to operate the system at higher ambient temperature conditions and provides a higher air flow through the chassis providing a better cooling of the system internal components.

7.6. Minimum System Clearance

To provide a maximum of airflow through and around the box, minimum distances to surrounding parts must be observed (please refer to the subsection 8.2 "Control Cabinet Mounting" and Figure 46 to Figure 52).

7.7. Maximum Temperatures

As the Intel® processors provide only certain settings for maximal power consumption some typically are used for the following table. This table can be seen as a guideline.

Table 18: Maximum Temperatures

Processor (Maximum Power Consumption)	KBox C-103-CFL without Fan Tray		KBox C-103-CFL with Fan Tray	
	Max. Ambient Temperature [°C]	Approx. System Internal Temp. Rise [°C] (Depending on Configuration)	Max. Ambient Temperature [°C]	Approx. System Internal Temp. Rise [°C] (Depending on Configuration)
Intel® Celeron™ G4930E (35 W)	65	10-20	70	5-10
Intel® Core™ i3-9100HL (25 W)	65	10-20	70	5-10
Intel® Core™ i5-8400H (45 W)	65	10-20	70	5-10
Intel® Core™ i7-9850HE (45 W)	60	10-20	65	5-10
Intel® XEON™ E-2276ME (45 W)	55	10-20	60	5-10



The maximum system ambient temperature depends mostly on the power consumption of the processor, chipset and third party components:

- ▶ Configurations with HDDs are limited to 50°C maximum ambient temperature.
- ▶ Configurations with wireless components (LTE, WiFi) are limited to 60°C ambient temperature.

For the temperature evaluation a specialized tool from Intel® was used to set the processor to a defined workload. Depending on the power consumption one or more cores were set to 70% workload. This includes the graphics core. The tool also handles the usage of the "Turbo Mode" of certain processor types.



The processor utilization depends highly on the software used. Software using multicore feature will run on several cores whereas standard software will only utilise one core. In this case the processor will use the "Turbo Mode" to increase the clock for the core with the highest workload, as long as the temperature is within limits.

7.8. Third Party Components

When the KBox C-103-CFL is extended and configured with third party components like PCIe extension cards and drives (HDD or SSD), it has to be taken into account that the air temperature inside the system is higher than the ambient temperature. An approximately internal temperature rise is given.

7.9. Processor Thermal Monitoring

The processor used with the KBox C-103-CFL system provides internal thermal monitoring. Every core of the processor comprises a temperature sensor.

To allow an optimal operation and long-term reliability, the processor must operate in the specified temperature range. To avoid overheating the processor performs an automatic thermal management, which intends to keep the processor temperature below the highest value of the temperature range. This behavior is a CPU standard feature.

7.10. Processor Thermal Trip Feature

The Processor Thermal Trip feature protects the processor from catastrophic overheating. The Thermal Trip Tensor threshold is set well above the normal operating temperature to ensure that there are no false trips. The processor will stop all executions when the junction temperature exceeds approximately 125°C. This event will be indicated by the red blinking "Thermal" LED on the front panel. This behavior cannot be altered. Once activated, the event remains latched until power is cycled.

8/ Installation Instructions

The KBox C-103-CFL comes with attached wall mount brackets. The available mounting key holes (Figure 25, pos. 1 and pos. 3) of the wall mounting brackets allow the unit attaching to a wall of a fire resistant enclosure.

Please observe the following safety and installation instructions:

- ▶ Whenever possible, unpack or pack this product only at EOS/ESD safe work stations. Where a safe work station is not guaranteed, it is important for the user to be electrically discharged before touching the product with his/her hands or tools. This is most easily done by touching a metal part of the system chassis.
- ▶ Do not handle this product out of its protective enclosure while it is not used for operational purposes unless it is otherwise protected.
- ▶ Prior any installation work ensure that there are no live wires on the installation site
- ▶ Do not handle the device if there is any damage visible.
- ▶ Do not operate the KBox C-103-CFL with foreign objects inside the chassis.
- ▶ Further do not insert any retrieval device into the device while it is connected to power.
- ▶ Kontron rejects all liability for any and all damages resulting from operation of the unit with foreign objects inside the chassis.
- ▶ The KBox C-103-CFL has to be installed and operated only by trained and qualified personnel.
- ▶ The KBox C-103-CFL system is designed for usage within control cabinets only.
- ▶ Only personnel with appropriate qualifications, trainings and authorization are permitted to install and work with the Kontron KBox C-103-CFL.
- ▶ This device shall only be installed in or connected to systems that fulfill all necessary technical and specific environmental requirements.
- ▶ The KBox C-103-CFL system is designed to be operated in vertical position with attached mounting brackets as shown in Figure 6 and Figure 7. It is not allowed to install the KBox C-103-CFL as a stand-alone (desktop) device.
- ▶ Do not remove the wall mounting brackets.
- ▶ The unit must be placed such that there is sufficient space in front of it for connecting the cables to the I/O interface connectors and for operating the power button.
- ▶ Leave sufficient free space around the unit to prevent the device from possibly overheating!
- ▶ To ensure proper operation, we recommended free space as specified below:
 - ▶ above and below: 100 mm (3.937")
 - ▶ left and right: 50 mm (1.96").
- ▶ See also Figure 46 to Figure 52 section 13.1 "Mechanical Specifications".
- ▶ It must be observed that all ventilation openings are not covered/obstructed by objects.
- ▶ The KBox C-103-CFL must be firmly attached to a clean flat and solid mounting surface. Use proper fastening materials suitable for the mounting surface. Ensure that the mounting surface type and the used mounting solution safely support the load of the KBox C-103-CFL and the attached components.
- ▶ Please follow the local/national regulations for grounding.
- ▶ The voltage feeds must not be overloaded. Adjust the cabling and the overcurrent protection to correspond with the electrical figures indicated on the type label.
- ▶ The type label is located on the right side of the system.
- ▶ It is recommended that the last cable attached to the system should be the power cable! Refer to the section 8.3 "DC Power Plug Terminal" and chapter 9/ "Starting Up".
- ▶ The unit is to be connected only to internal Ethernet networks without exiting a facility and being subjected to TNVs.
- ▶ External circuits connected to the device shall be SELV/PELV (galvanic separated from mains by double or reinforce insulation).
- ▶ Use copper conductors according to the specification of the field wiring terminal.
- ▶ Minimum temperature rating of the cables connected to the field wiring terminals is 77° C.

8.1. Specifications of the internal M.2 Connectors

Table 19: Specifications of the internal M.2 Connectors

M.2 Connector No.	J13	J17	J18
M.2 Connector type	B-Type	M-Type	B-Type
PCIe lanes/ Gen	X1 / G3	X4 / G3	X1 / G3
SATA	no	no	yes ¹
USB	2.0	no	2.0
MicroSIM	yes	no	no
Mech. Format			
2230	yes	no	no
3030	yes	no	no
2242	yes	yes	yes
3042	yes	no ²	no ²
2260	no	yes	yes
2280	no	yes	yes

yes¹: muxed with SATA0/J24

no²: possible

8.2. Control Cabinet Mounting



Expansion card installation should be performed before installing the KBox C-103-CFL into the control cabinet.

CAUTION

Please observe the "General Safety Instructions for IT Equipment" (included) and the installation instructions (refer to the chapters 1/ and 8/).

Your KBox C-103-CFL is supplied with assembled mounting brackets. The key holes of the upper and lower mounting brackets (Figure 25, pos. 1 and pos. 3) allow you to mount the KBox C-103-CFL to a mounting side of the control cabinet in vertical position. This is the only permitted operating position.



For a sufficient air circulation around the device, we recommend not to place (mount) or operate any other devices within the "keep out area". The clearances of "50mm" and "100mm" around the KBox C-103-CFL must be observed; refer to the marked areas in Figure 46 to Figure 52.

Prepare the mounting surface with four screws and if necessary anchors corresponding to the mounting surface type (fire-resistant material). Please refer to the information for mounting to the section 13.1, "Mechanical Specifications of the KBox C-103-CFL", and the subsections 13.1.1 / 13.1.4 / 13.1.5 / 13.1.6 and 13.1.7, or refer to the drawings for KBox C-103-CFL on our web site. The drawings can be downloaded from our web site www.kontron.com by selecting the product.

Figure 46: Keep out area for mounting around KBox C-103-CFL-4 (front side view without fan tray)

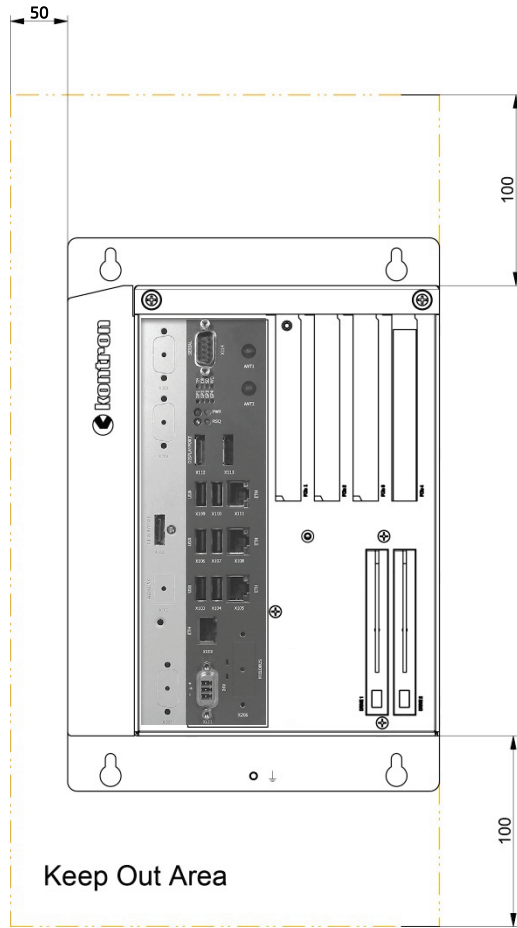


Figure 47: Keep out area for mounting around KBox C-103-CFL-4 (front side view with optional fan tray)

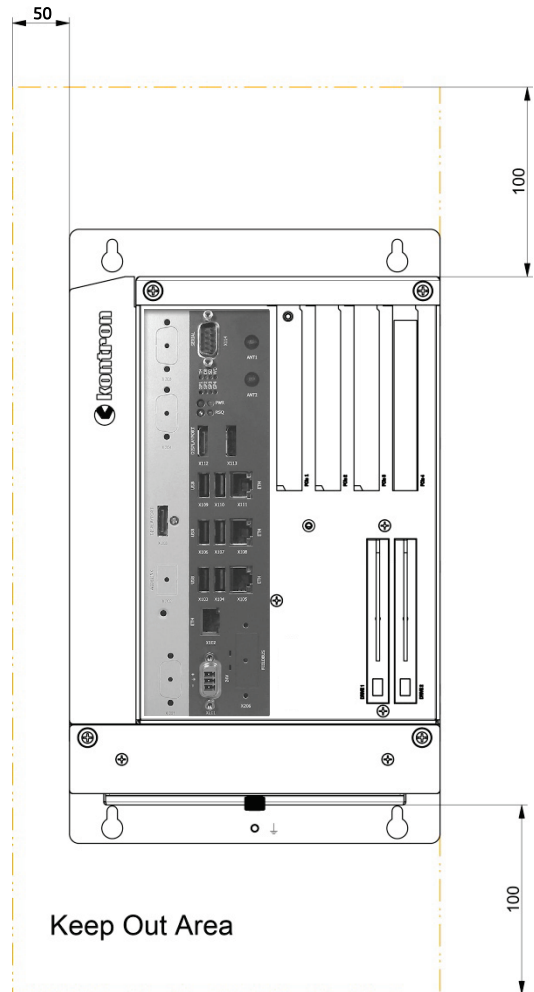


Figure 48: Keep out area for mounting around KBox C-103-CFL-2 (front side view without fan tray)

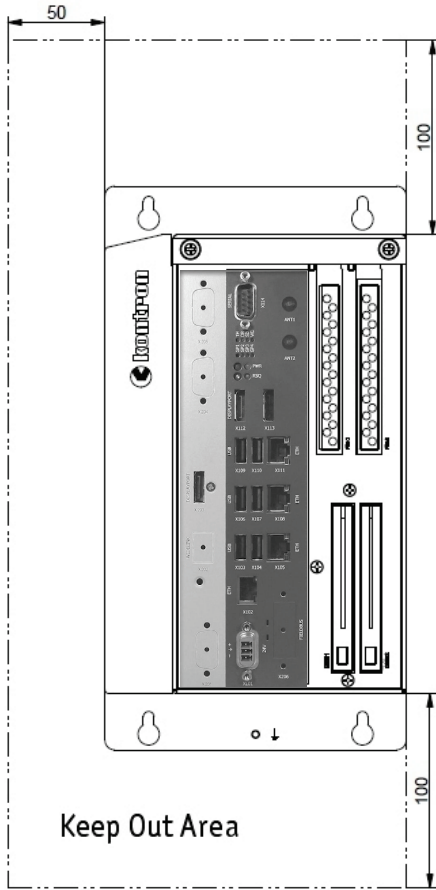


Figure 49: Keep out area for mounting around KBox C-103-CFL-2 (front side view with optional fan tray)

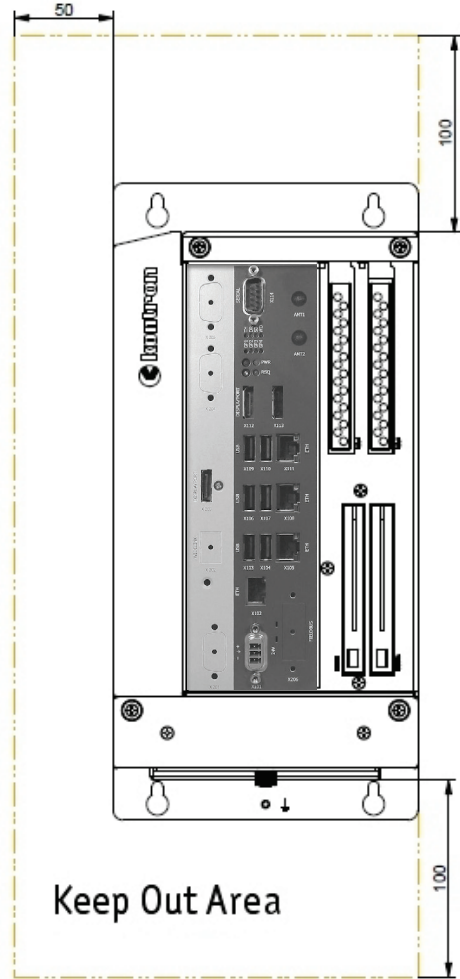


Figure 50: Keep out area for mounting around KBox C-103-CFL-1 (front side view without fan tray)

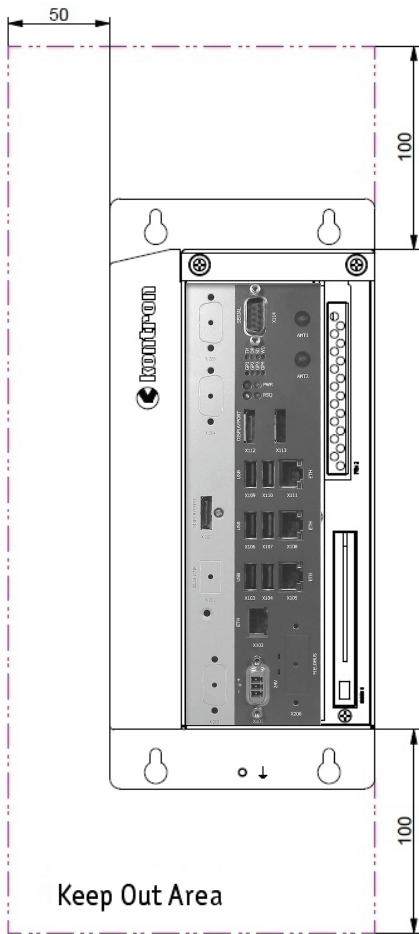


Figure 51: Keep out area for mounting around KBox C-103-CFL-1 (front side view with optional fan tray)

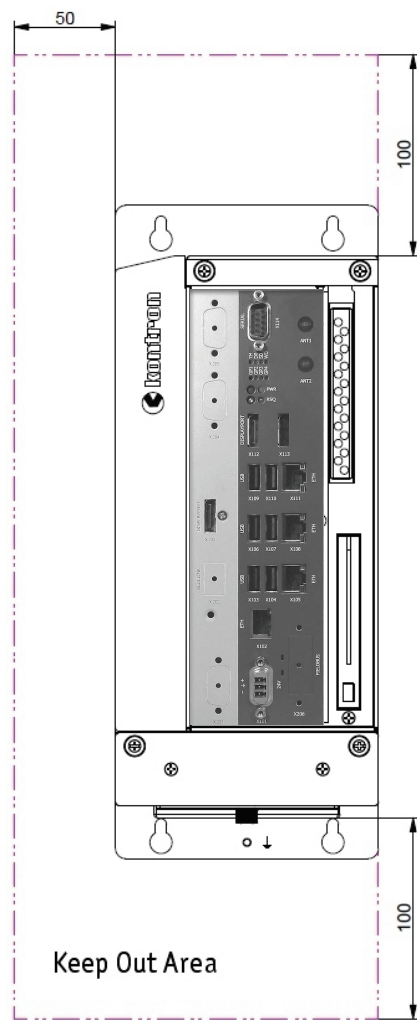
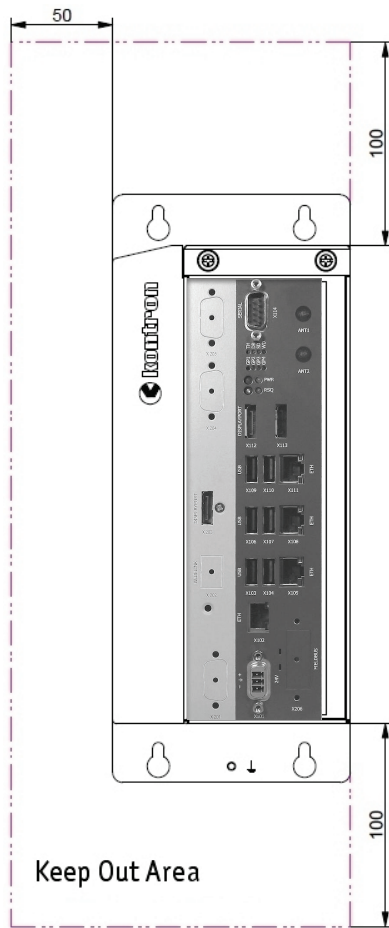


Figure 52: Keep out area for mounting around KBox C-103-CFL-0

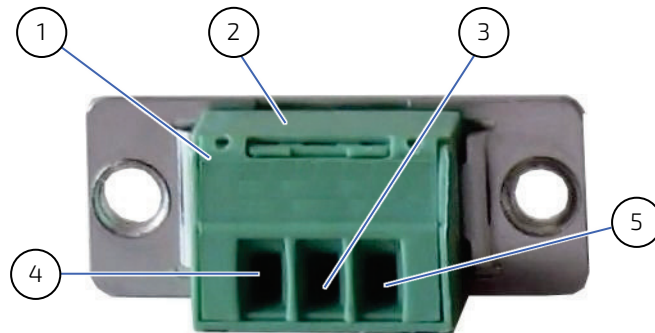


8.3. DC Power Plug Terminal

The KBox C-103-CFL is connected by a Phoenix connector to a DC power source via a DC power supply wiring (only the Phoenix power plug terminal is included).

The KBox C-103-CFL is delivered with a DC power plug terminal (3-pin Phoenix connector). For DC connection, prepare the connecting wires using the supplied Phoenix plug terminal: PSC 1,5/ 3-F.

Figure 53: Phoenix power plug terminal



- | | | | |
|---|--|---|---------------------------------------|
| 1 | 3-pin Phoenix plug terminal | 4 | Location for inserting the "24V" wire |
| 2 | Cover over the slotted pan head screws | 5 | Location for inserting the "0V" wire |
| 3 | Location for inserting the functional earth wire | | |

8.3.1. Cabling

For the pin assignment Phoenix power plug terminal refer to the subsection 4.5.1 "X101/X201 – Power Input Connectors".

1. Cut the required length three isolated wires (1 mm²) AWG18 and strip each end 5 –7 mm.
2. Twist the striped wire-ends and provide them with ferrules.
3. Open the cover (Figure 53, pos. 2) to have access to the slotted pan head screws.
4. Loosen the slotted pan head screws of the DC plug terminal far enough so that you can insert the end of the prepared wires.
5. Insert the wires into the corresponding clamp of the Phoenix plug terminal. Make sure that you have the right polarity of the connection [refer to Figure 53, Figure 14 or subsection 14.1.1, "(X101) Power Input Connector "].
6. Fasten the screws to secure the wires into the clamps of the plug terminal.
7. Close the cover (Figure 53, pos. 2).

8.4. Side Wall Mounting (Option)

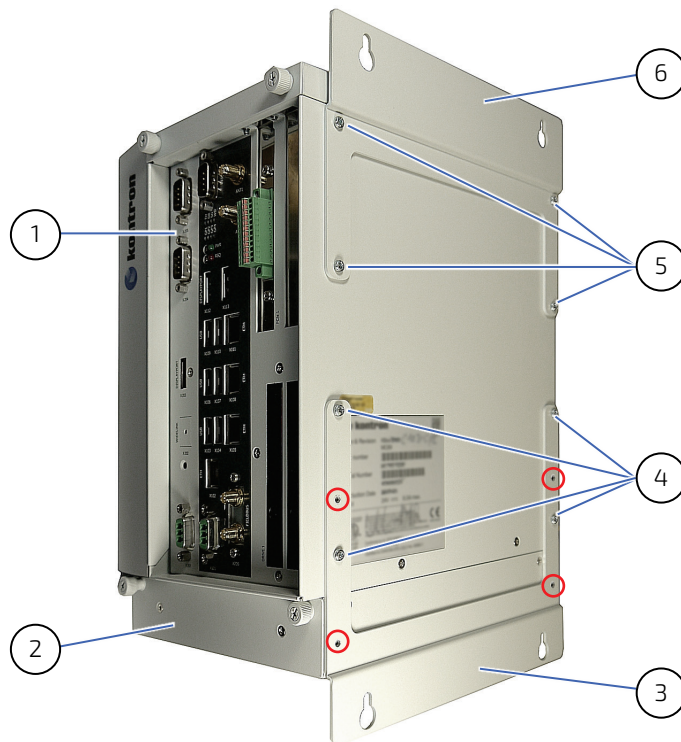
Your KBox C-103-CFL can be mounted with optionally available side wall mounting brackets. The key holes of the upper and lower mounting brackets (Figure 54, pos. 3 and pos. 6) allow you to mount the KBox C-103-CFL to a mounting side of the control cabinet in vertical position. This is the only permitted operating position. The lower side wall mounting bracket has different holes for mounting with and without fan tray (Figure 54, pos. 3 and pos. 4).



For a sufficient air circulation around the device, we recommend not to place (mount) or operate any other devices within the "keep out area". The clearances of "50mm" and "100mm" around the KBox C-103-CFL must be observed; refer to the marked areas in Figure 46 to Figure 52. (This applies to the standard brackets as well as to the side wall mounting brackets.)

Prepare the mounting surface with four screws and if necessary anchors corresponding to the mounting surface type (fire-resistant material). Please refer to the information for mounting to the section 13.1, "Mechanical Specifications of the KBox C-103-CFL", and the subsections 13.1.1 / 13.1.4 / 13.1.5 / 13.1.6 and 13.1.7, or refer to the drawings for KBox C-103-CFL on our web site. The drawings can be downloaded from our web site www.kontron.com by selecting the product.

Figure 54: KBox C-103-CFL-2 with fan tray and side wall mounting brackets



- | | | | |
|---|---|---|---|
| 1 | KBox C-103-CFL-2 | 4 | Mounting screws of the lower side wall mounting bracket, using the holes for mounting with fan tray present |
| 2 | Fan tray (optional) | 5 | Mounting screws of the upper side wall mounting bracket |
| 3 | Lower side wall mounting bracket with key holes, mounted in the "with fan tray" position. | 6 | Upper side wall mounting bracket with key holes |
- Red circles:** Mounting holes for the lower side wall mounting bracket if no fan tray is present

9/ Starting Up



The KBox C-103-CFL must be operated only with the nominal voltage of 24V DC of type SELV. For details refer to the chapter 13/ "Technical Specifications".

9.1. Connecting to DC Main Power Supply

The DC input connector (Figure 11 and Figure 14 marked X101) is located on the front side of the KBox C-103-CFL. The KBox C-103-CFL will be connected to a DC main power supply via the supplied Phoenix power plug terminal (see Figure 53) and corresponding power wires (prepared as described in the subsection 8.3.1 "Cabling").

NOTICE

Before using your system, become familiar with the system components and check that everything is properly connected. Following a proper cabling procedure will prevent a false power-on condition, which could result in unit operational failure.

When you install/disconnect the unit, the functional earth connection must always be made first and disconnected last.

Also, it is recommended that the last connections attached to the system should be the power wires!

CAUTION

The KBox C-103-CFL must be connected to a DC mains power supply complying with the requirements of IEC 61010-1 and IEC 60950-1 standard or better. It must be observed that wiring and short-circuit/overcurrent protection is performed according to the applicable standards, regulations and respect to the electrical specification of the KBox C-103-CFL.

Even when the system is turned off via the power button (Figure 11 and Figure 15, marked PWR) parts of the system are still energized.

The disconnecting device (fuse/circuit breaker) rating must be in accordance with the wire cross-section and the rated current of the KBox C-103-CFL.

NOTICE

The wires used for power connections must be clearly marked (+/-/functional earth) to ensure that they will be properly connected to the DC IN connector of the KBox C-103-CFL and to the main power source, corresponding to signals marked; refer to Figure 14 and Figure 53. In addition, the cables must have some form of support so as to minimize the strain on the unit's connectors.

NOTICE

Only connect to an external power supply delivering the specified input rating and complying with the requirements of Safety Extra Low Voltage (SELV) and Limited Power Source (L.P.S.) of UL/IEC 60950-1 or (PS2) of UL/IEC 62368-1.

To connect the KBox C-103-CFL to a corresponding DC main power supply, please perform the following steps:

1. Ensure that the DC power source is switched off via a disconnecting device (circuit breaker), in order to ensure that no power is flowing from the external DC power source during the connection procedure.
2. Connect at first the wire for "Functional Earth stud" (Figure 25, pos. 6) to an appropriate "common earth" connection point.
3. Connect the Phoenix power terminal prepared as described in the subsection 8.3.1 "Cabling" to the DC input connector (Figure 11 and Figure 14 marked X101) of the KBox C-103-CFL. The DC input connector is located on the front side and is marked "24VDC".

4. Connect the other ends of the DC power wires to the connections of the DC main power supply. Pay attention to the polarity of the connections.
5. Switch on the disconnecting device (circuit breaker) in order to apply voltage to the terminals of the power wires.

9.2. Power OFF/ON Procedure

As the KBox C-103-CFL is equipped with an internal hold-up buffer, it can't be powered off/on immediately. The buffer time depends on the power consumption and load on the KBox C-103-CFL processor and peripherals. Therefore the following procedure must be observed.

1. Close your applications and perform an orderly shutdown (graceful shutdown).
2. Remove power from the system.
3. Wait until the green power LED (Figure 15, pos. 2) stops blinking.
4. Reapply power.

Refer also to the subsection 4.5.7 "POWER Button and PWR LED".

NOTICE

Do not disconnect the power from your system while it is powered up!
Performing a forced shutdown can lead to loss of data or other undesirable effects!

9.3. Operating System and Hardware Component Drivers

Your system can be supplied optionally with a pre-installed operating system.

If you have ordered your KBox C-103-CFL with a pre-installed operating system, all drivers are installed in accordance with the system configuration ordered (optional hardware components). Your system is fully operational when you power it on for the first time.

If you have ordered The KBox C-103-CFL without a pre-installed operating system, you will need to install the operating system and the appropriate drivers for the system configuration you have ordered (optional hardware components) yourself.



You can download the relevant drivers for the installed hardware from our web site at www.kontron.com by selecting the product.
Pay attention to the manufacturer specifications of the operating system and the integrated hardware components.

10/ Maintenance and Cleaning

Equipment from Kontron requires only minimum servicing and maintenance for proper operation.

- ▶ For light soiling, clean the KBox C-103-CFL with a dry cloth.
Carefully remove dust from the surface of the cooling fins of the chassis using a clean, soft brush.
- ▶ Stubborn dirt should be removed using a mild detergent and a soft cloth.

NOTICE

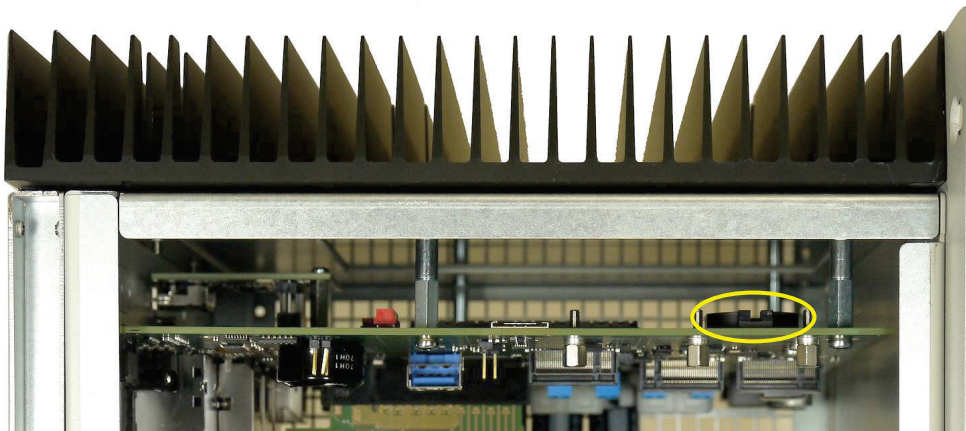
Do not use steel wool, metallic threads or solvents like abrasives, alcohol, acetone or benzene for cleaning the KBox C-103-CFL.

10.1. Replacing the Lithium Battery

If your KBox C-103-CFL is equipped with the optional lithium battery (CR 2032, 3V, internally accessible), and you have to replace it, please proceed as follows:

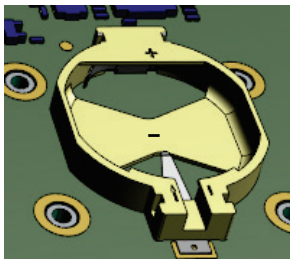
1. Open the topside access cover as describes in chapter 6.2 "Opening and Closing the KBox C-103-CFL"
2. The battery is located on the side of the baseboard that faces to the cooling fins (see Figure 55).

Figure 55: Location of the optional Lithium battery



3. Remove the lithium battery from the holder by pulling it outwards.
4. Place a new lithium battery in the battery holder.
5. Pay attention to the polarity of the battery: the plus pole must face to the top side, the minus pole to the bottom side of the battery holder (see Figure 56).

Figure 56: Lithium battery polarity



6. The lithium battery must only be replaced with the same type of battery or with a type of battery recommended by Kontron Europe.
7. Close the top access cover.

CAUTION

Danger of explosion when replacing with wrong type of battery. Replace only with the same or equivalent type recommended by the manufacturer. The lithium battery type must be UL recognised.



Do not dispose of lithium batteries in general trash collection. Dispose of the battery according to the local regulations dealing with the disposal of these special materials, (e.g. to the collecting points for dispose of batteries).

10.2. Preventive Maintenance for SSD Drives

This section applies to all M.2 and SSD devices installed into the KBox C-103-CFL system.



Because of the limited predetermined lifespan of the M.2/SATA SSD devices, we recommend to check the condition of your installed SSD drives via S.M.A.R.T. regularly.
Pay attention to the manufacturer specifications for lifespan.

For replacing of these devices refer to the sections: 4.5.11 and 6.3.7.

10.3. Replacing the Fan Tray

NOTICE

The operation of the KBox C-103-CFL versions with fan tray extension is permitted only with a functional fan tray!

Defective components may only be replaced by Kontron original spare parts:

- ▶ Part number of the fan tray: 9-5000-1096 for KBox C-103-CFL-4
- ▶ Part number of the fan tray: 9-5000-1095 for KBox C-103-CFL-2
- ▶ Part number of the fan tray: 9-5000-1094 for KBox C-103-CFL-1

The fan tray can be replaced during operation. This should only be carried-out by qualified personnel aware of the associated dangers.

The fan will not stop immediately when the fan tray is removed during operation. Pull out the fan tray only a few centimeters and wait until the fan comes to stop.

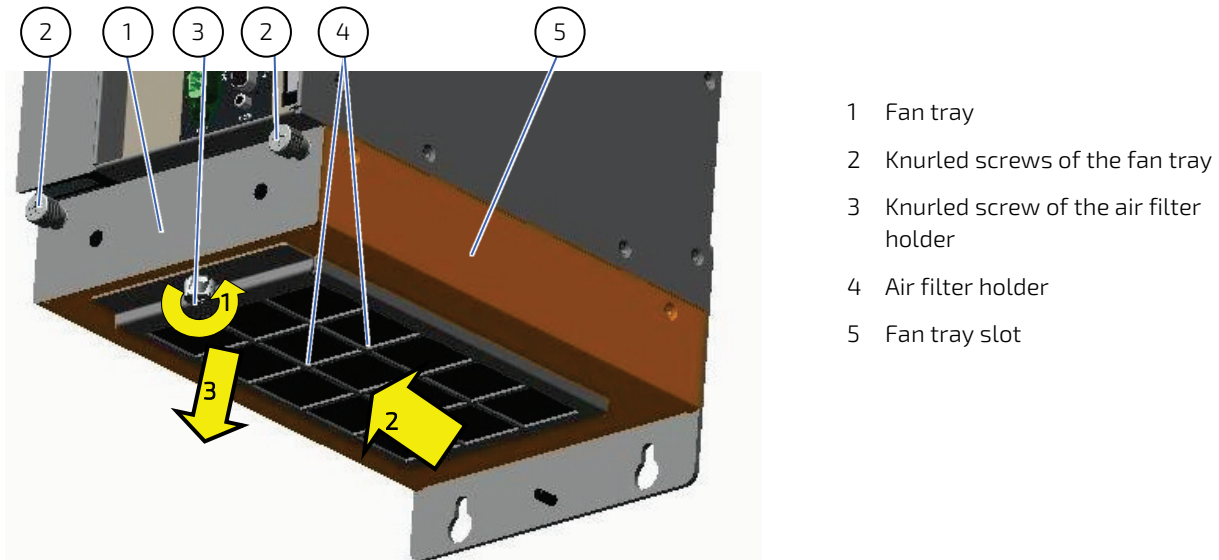
To replace fan tray, proceed as follows:

1. Ensure to have access to the bottom side of the KBox C-103-CFL-4/-2/-1. The fan tray (Figure 57, pos. 1 and Figure 58, pos. 2) may be replaced without removing the air filter holder (Figure 57, pos. 4).
2. Loosen the two knurled screws (Figure 57, pos. 2) of the fan tray.
3. Pull the fan tray (Figure 58, pos. 2) out from the fan tray slot (Figure 58, pos. 3) in order to disconnect the connector for fan power and control (Figure 33, pos. 3) from the internal fan control socket (Figure 58, pos. 10).
4. Pull the fan tray completely out from the fan tray slot (Figure 58, pos. 3).
5. Replace the defective fan tray with a new one.
6. Insert the functional fan tray (Figure 58, pos. 2) into the fan tray slot (Figure 58, pos. 3).
7. Secure the fan tray by fastening the knurled screws (Figure 57, pos. 2). By fastening of the knurled screws the proper insertion of the fan tray into the internal socket (Figure 58, pos. 10) is ensured.

10.4. Cleaning the Air Filter

The air filter is inserted in the holder (Figure 32, pos. 2) at the bottom side of the fan tray slot (Figure 32, pos. 6). The soiling of the air filter (Figure 32, pos. 3) is caused by the pollution of the operating environment. A heavily soiled air filter can cause excessive heating of the device. For this reason we recommend to clean the air filter as often as necessary. The air filter can be changed during operation of the system.

Figure 57: Fan tray extension (detail: shown as KBox C-103-CFL-1)



To replace the air filter, proceed as follows:

1. Ensure to have access to the bottom side of the KBox C-103-CFL-4/-2/-1. The air filter may be replaced without removing the fan tray (Figure 57, pos. 1).
2. Loosen the knurled screw (Figure 57, pos. 3) that secures the air filter holder (Figure 57, pos. 4) to the fan tray slot (Figure 57, pos. 5); refer to step 1 in Figure 57.
3. Pull the air filter holder out of the positioning holes, (Figure 58, pos. 9) into the marked direction (see Figure 57) and pull it down. Put the air filter holder aside for later reassembly; refer to step 2 and 3 in Figure 57.
4. Remove the soiled air filter (Figure 57, pos. 3 and Figure 58, pos. 6).
5. Clean the air filter as follows:
6. Rinse in water (up to approx. 40°C; possibly with the addition of a standard mild detergent).
7. It is possible to clean the air filter with compressed air.
8. For dirt that contains grease/oil, the air filter should be rinsed with warm water with the addition of a degreaser. Air filter should not be cleaned with powerful water jets or wrung out.
9. After cleaning and drying the air filter, place it in the air filter holder.
10. Reattach the air filter holder to the bottom side of the fan tray slot by inserting the positioning latches (Figure 58, pos. 8) into the positioning holes (Figure 58, pos. 9).
11. Secure the air filter holder by tightening the knurled screw to the tapped hole (Figure 58, pos. 4) of the fan tray slot (Figure 57, pos. 5 or Figure 58, pos. 3).

NOTICE

Defective components may only be replaced by Kontron original spare parts.

- ▶ Air filter: part number: 9-5000-1099 (for KBox C-103-CFL-4)
- ▶ Air filter: part number: 9-5000-1098 (for KBox C-103-CFL-2)
- ▶ Air filter: part number: 9-5000-1097 (for KBox C-103-CFL-1)



The pictures in this section correspond to a KBox C-103-CFL-2 system.
 The description of the procedure for cleaning the air filter can be applied to all KBox C-103-CFL-4/-2/-1 variants, under consideration of the different mechanical specifications.

Figure 58: KBox C-103-CFL-2 with removed fan tray and removed air filter

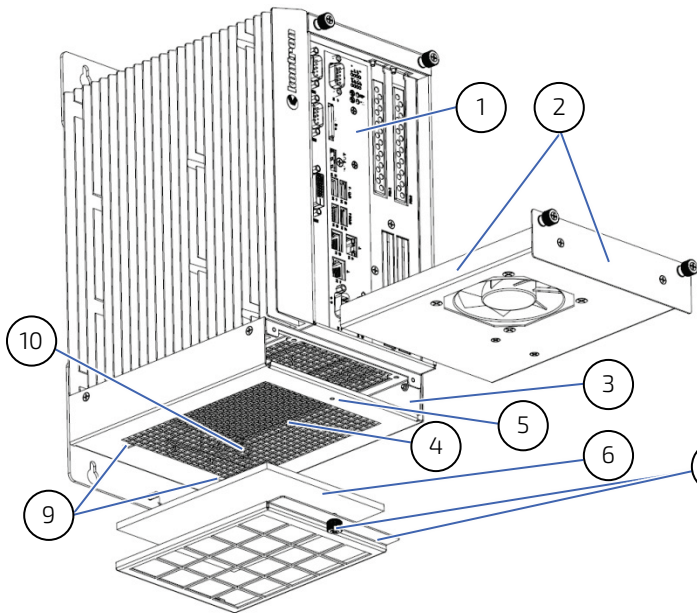


Figure 59: Filter mat Holder without air filter

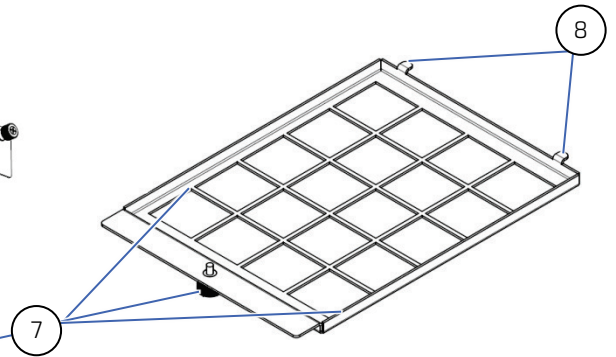


Figure 60: Holder (shown for KBox C-103-CFL-2) with air filter

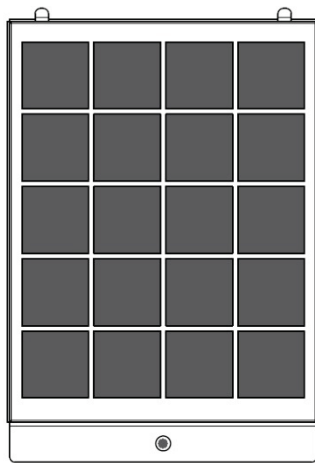
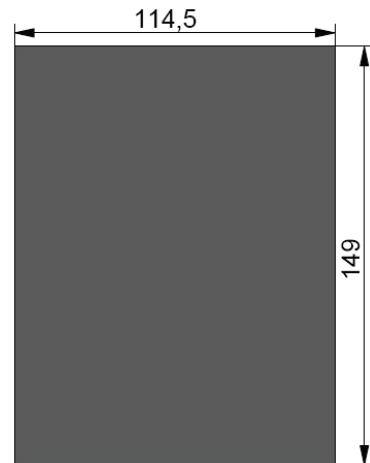


Figure 61: Air filter (shown for KBox C-103-CFL-2)



- | | |
|--|---|
| <ul style="list-style-type: none"> 1 KBox C-103-CFL assembled with the optional fan tray slot 2 Removed fan tray 3 Fan tray slot without inserted fan tray 4 Air intake openings at the bottom side of the fan tray slot 5 Tapped hole to secure the knurled screw of the air filter holder | <ul style="list-style-type: none"> 6 Removed air filter 7 Air filter holder with knurled screw 8 Positioning latches of the air filter holder 9 Positioning holes for the air filter holder 10 Socket for fan power and control (on internal rear side of the fan tray slot) |
|--|---|

11/ uEFI BIOS

11.1. Starting the uEFI BIOS

The KBox C-103-CFL-x is provided with a Kontron-customized, pre-installed and configured version of AMI Aptio® V uEFI BIOS based on the Unified Extensible Firmware Interface (uEFI) specification and the Intel® Platform Innovation Framework for EFI. This uEFI BIOS provides a variety of new and enhanced functions specifically tailored to the hardware features of the KBox C-103-CFL-x.



The BIOS version covered in this document might not be the latest version. The latest version might have certain differences to the BIOS options and features described in this chapter.



Register for the EMD Customer Section to get access to BIOS downloads and PCN service.

The uEFI BIOS comes with a Setup program that provides quick and easy access to the individual function settings for control or modification of the uEFI BIOS configuration. The Setup program allows for access to various menus that provide functions or access to sub-menus with further specific functions of their own.

To start the uEFI BIOS Setup program, follow the steps below:

1. Power on the board.
2. Wait until the first characters appear on the screen (POST messages or splash screen).
3. Press the key.
4. If the uEFI BIOS is password-protected, a request for password will appear. Enter either the User Password or the Supervisor Password, press <RETURN>, and proceed with step 5.
5. A Setup menu appears.

The KBox C-103-CFL-x uEFI BIOS Setup program uses a hot key navigation system. The hot key legend bar is located at the bottom of the Setup screens. The following table provides a list of navigation hot keys available in the legend bar.

Table 20: Navigation Hot Keys Available in the Legend Bar

Sub-screen	Description
<F1>	<F1> key invokes the General Help window
<->	<Minus> key selects the next lower value within a field
<+>	<Plus> key selects the next higher value within a field
<F2>	<F2> key loads previous values
<F3>	<F3> key loads optimized defaults
<F4>	<F4> key Saves and Exits
<←> or <↔>	<Left/Right> arrows selects major Setup menus on menu bar, for example, Main or Advanced
<↑> or <↓>	<Up/Down> arrows select fields in the current menu, for example, Setup function or sub-screen
<ESC>	<ESC> key exits a major Setup menu and enters the Exit Setup menu Pressing the <ESC> key in a sub-menu displays the next higher menu level
<RETURN>	<RETURN> key executes a command or selects a submenu

11.2. Setup Menus

The Setup utility features menus listed in the selection bar at the top of the screen:

- ▶ Main
- ▶ Advanced
- ▶ Chipset
- ▶ Security
- ▶ Boot
- ▶ Save & Exit

The left and right arrow keys select the Setup menus. The currently active menu and the currently active uEFI BIOS Setup item are highlighted in white.

Each Setup menu provides two main frames. The left frame displays all available functions. Configurable functions are displayed in blue. Functions displayed in grey provide information about the status or the operational configuration. The right frame displays an Item Specific Help window providing an explanation of the respective function.

11.2.1. Main Setup Menu

On entering the uEFI BIOS the Setup program displays the Main Setup menu. This screen lists the Main Setup menu sub-screens and provides basic system information as well as functions for setting the system language, time and date.

Figure 62: Main Setup Menu

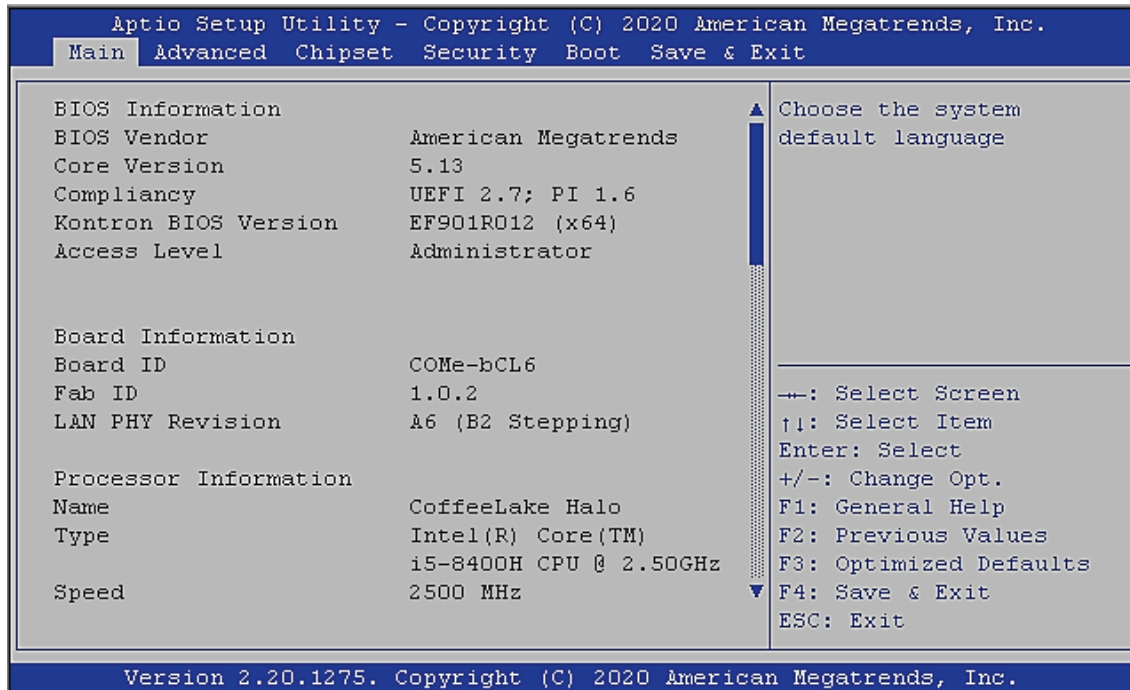


Table 21: Main Setup Menu Sub-screens and Functions

Sub-screen	Description
BIOS Information	Read only field Displays information about the BIOS system Vendor, Core version, Compliancy, Kontron BIOS Version, and Access level
Board Information	Read only field Board ID, Fab ID, LAN PHY Revision
Processor Information	Read only field Displays information about the CPU Name, Type, Speed, Processor ID, Stepping, Package, Number of Processors, Microcode Version, GT Info and eDRAM size,
(Memory Information)	Read only field Displays information about eDRAM Size, IGFX VBIOS/IGFX GOP/Memory RC Version, Total Memory and Memory Frequency
PCH Information	Read only field Displays information about the PCH Name, PCH SKU, Stepping, ChipsetInit Base/ChipsetInit OEM Revision, Package, TXT Capability of Platform/PCH, Production Type, ME FW Version and ME Firmware SKU
ME FW	Read only field ME Firmware Version, ME Firmware Consumer SKU
System language	Selects system language

Sub-screen	Description
Platform Information	Read only subscreen Module Information: Displays information about Product Name, Revision Serial #, MAC Adress, Boot Counter and CPLD Revision Carrier Board Information: Displays information about Product Name, Revision, Serial # and Carrier Board ID
System Date	Displays System Date
System Time	Displays System Time

11.2.2. Advanced Setup Menu

The Advanced Setup menu provides sub-screens and second level sub-screens with functions, for advanced configuration and Kontron specific configurations.

NOTICE

Setting items, on this screen, to incorrect values may cause system malfunctions.

Figure 63: Advanced Setup Menu

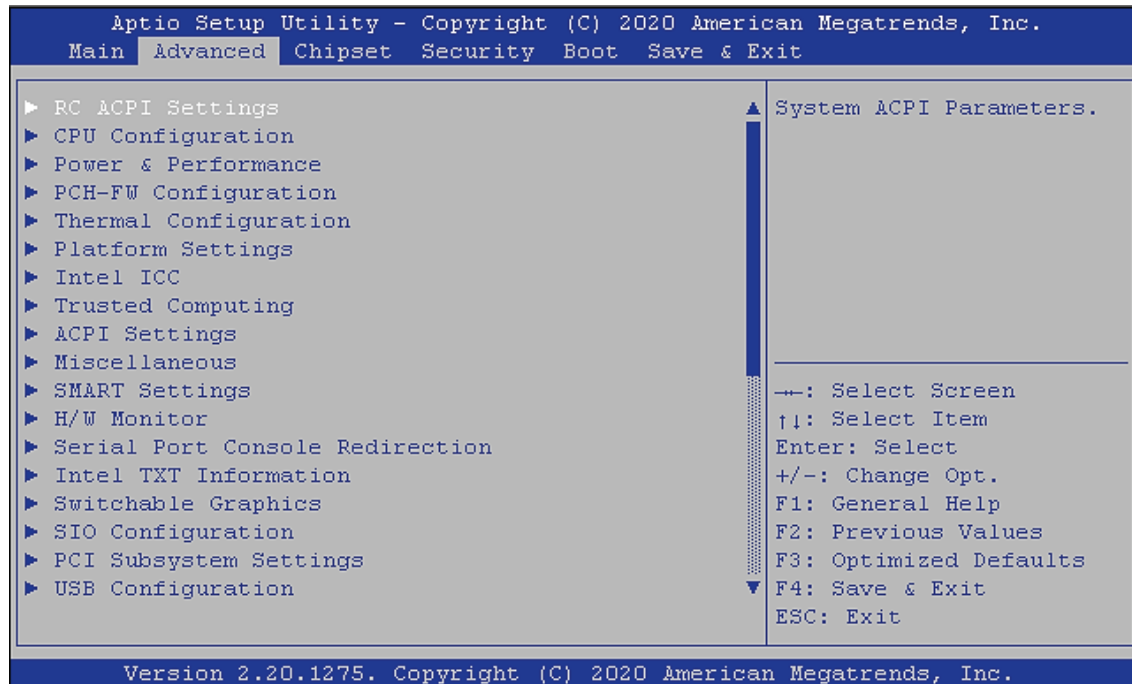


Table 22: Advanced Setup menu Sub-screens and Functions

Sub-Screen	Function	Second level Sub-Screen / Description
RC ACPI	PTID Support	Enable/Disable
	PECI Access Method	Direct I/O /ACPI
	Native PCIe Enable	Enable/Disable
	Native ASPM	Auto/ Enable/Disable
	Wake System from S5 via RTC	Enable/Disable
	ACPI Debug	Enable/Disable
	Low Power S0 Idle Capability	Enable/Disable
	PCI Delay Optimization	Enable/Disable
	MSI enabled	Enable/Disable
CPU Configuration	C6DRAM	Enable/Disable
	Software Guard Extensions (SGX)	Software Controlled/ Enable/Disable
	Select Owner EPOCH input type	No Change in Owner EPOCHs/Change to New Random Owner EPOCHs/Manual User Defiened Owner EPOCHs

Sub-Screen	Function	Second level Sub-Screen / Description		
	CPU Flex Ratio Override	Enable/ Disable		
	Intel (VMX) Virtualization Technology>	Enable /Disable		
	Active Processor Cores>	All /1/2/3		
	Hyper Threading>	Enable /Disable		
	BIST	Enable/ Disable		
Power & Performance	CPU Power Management Control	Boot Performance Mode	Max Non-Turbo Performance	
		Intel SpeedStep	Enable /Disable	
		Intel Speed ShiftTechnology	Enable /Disable	
		Turbo Mode	Enable /Disable	
		View/Configure Turbo Options		
		Config TDP Configurations		
		Platform PL1 Enable	Enable/ Disable	
		Platform PL2 Enable	Enable/ Disable	
		Platform PL4 Override	Enable /Disable	
		Platform PL4 Power	0	
		Platform PL4 Lock	Enable /Disable	
		C states	Enable /Disable	
	Package C State Limit	Auto		
	GT Power Management Control	RC6 (Render Standby)	Enable /Disable	
		Maximum GT frequency	Default Max Frequency	
Disable Turbo GT frequency		Enable/ Disable		
Performance Mode	Performance Mode			
	Real Time Mode	See Table 25		
PCH-FW Configuration	ME State	Enable		
	Firmware Update Configuration	ME FW Image Re-Flash	Enable/ Disable	
		Local FW Update	Enable /Disable	
PTT Configuration	TPM Device Selection	dTPM/PTT		
Thermal Configuration	CPU Thermal Configuration	DTS SMM	Enable/ Disable	
		TCC Activation Offset	0	
		Disable PROCHOT# Output	Enable /Disable	
	Platform Thermal Configuration	Automatic Thermal Reporting	Enable/ Disable	
		Critical Trip Point	119 C (POR)	
		Passive Trip Point	95 C	
		Passive TC1 value	1	
		Passive TC2 value	5	
		Passive TSP value	10	
Passive Trip Points	Enable/ Disable			
Critical Trip Point	Enable /Disable			

Sub-Screen	Function	Second level Sub-Screen / Description	
Platform Settings	System Time and Alarm Source	ACPI Time and Alarm Device /Legacy RTC	
Intel ICC	ICC/OC Watchdog Timer	Enable/ Disable	
	ICC Profile	0	
	ICC PLL Shutdown	Enable /Disable	
	BCLK Clock Settings	Spread %: 47	
Trusted Computing	Security Device Support	Enable /Disable	
	SHA-1 PCR Bank	Enable /Disable	
	SHA256 PCR Bank	Enable /Disable	
	Pending Operation	None	
	Platform Hierarchy	Enable /Disable	
	Storage Hierarchy	Enable /Disable	
	Endorsement Hierarchy	Enable /Disable	
	TPM 2.0 UEFI Spec Version	TCG_2	
	Physical Presence Spec Version	1.3	
	Device Select	Auto	
ACPI settings	Enable ACPI Auto Configuration>	Enable/ Disable	
	Enable Hibernation>	Enable /Disable	
	ACPI Sleep State	S3 (Suspend to RAM) /Suspend Disabled	
	Lock Legacy Resources>	Enable/ Disable	
	S3 Video Repost>	Enable/ Disable	
Miscellaneous	Watchdog	Auto-Reload	Enable/Disable
		Global Lock	Enable/Disable
		Stage 1 Mode	Enable/Disable
	Reset Button Behavior	Chipset Reset /Power Cycle	
	I2C Speed	200	
	Onboard I2C Mode	Multimaster /Busclear	
	ACPI temperature polling	Enable /Disable	
	TZ00 temperature polling	30	
	Control COMe GPIOs in BIOS	Enable/ Disable	
	GPIO IRQ #	Enable/ Disable	
	I2C IRQ #	Enable/ Disable	
SMART Settings	SMART Self Test	Enable/ Disable	
H/W Monitor	Fan Control	Auto	
	Fan Pulse	2	

Sub-Screen	Function	Second level Sub-Screen / Description		
	Fan Trip Point	50		
	Trip Point Speed	50		
	Reference Temperature	CPU Temperature/Module Temperature		
	External Fan: Fan Control	Auto		
	Fan Pulse	2		
	Fan Trip Point	50		
	Trip Point Speed	50		
	Reference Temperature	CPU Temperature		
Serial Port Console Redirection	COM0 Console Redirection	Enable/ Disable		
	Console Redirection Settings	Terminal Type	VT100/VT100+/VT-UTF8/ANSI	
		Bits per Second	9600/19200/38400/57600/115200	
		Data Bits	7/8	
		Parity	None/Even/Odd/Mark/Space	
		Stop Bits	1/2	
		Flow Control	None/Hardware RTS/CTS	
		VT-UTF8 Combo Key Support	Enabled/Disabled	
		Recorder Mode	Disabled/Enabled	
		Resolution 100x31	Disabled/Enabled	
	Putty Keypad	VT100/LINUX/XTERM6/SCO/ESCN/VT400		
	COM1 Console Redirection	Enable/ Disable		
	Legacy Console Redirection	Redirection COM Port [COM0, COM1]		
		Resolution [80x24, 80x25]		
Redirection After POST [Always Enable, Bootloader]				
Console Redirection	Enable/ Disable			
Intel TXT Inf.	Read-only field	Displays Intel TXT information		
Switch. Graphics	Read-only field	SG Mode Select [Muxless]		
SIO Configuration	Serial Port #1 X114	Use this device	Enabled / disabled	
		Possible	IO=3F8h; IRQ=4	
	Mode	RS232		
		RS485 (single) Term Off		
		RS422 (single) Term Off		
		RS485 (Dual) Term Off		
		RS422 (Dual) Term Off		
		RS485 (single) Term On		
		RS422 (single) Term On		

Sub-Screen	Function	Second level Sub-Screen / Description	
	Serial Port #2 X205		RS485 (Dual) Term On
			RS422 (Dual) Term On
		Use this device	Enabled / disabled
		Possible Mode	IO=2F8h; IRQ=3
			RS232
			RS422/485 Support
PCI Subsystem Settings	BME DMA Mitigation	Enable/ Disable	
USB Configuration	Legacy USB Support	Enable /Disable	
	XHCI Hand-Off	Enable /Disable	
	USB Mass Storage Driver Support	Enable /Disable	
	USB transfer time-out	20 sec	
	Device reset time-out	20 sec	
	Device power-up delay	Auto	
	Generic Ultra HS-SD/MMC	Auto /Floppy/Forced FDD/Harddisk/CD-ROM	
CSM Configuration	CSM Support	Enable/ Disable	
NVMe Configuration			

NOTICE**Additional Watchdog Information**

The COMe-bCL6 provides a two-staged watchdog with:

Programmable stages to trigger different actions - If one stage is disabled, then the next stage is also disabled.

Common actions for a watchdog trigger events 'Delay', 'Reset' and 'Watchdog signal only' CPLD code allows for triggering NMI or SCI. This needs programming of a predefined action inside the BIOS and therefore can only be used in a customized BIOS solution.

Timeouts that can be set to eight different fixed values between 1 second and 30 minutes.

NOTICE**Additional Information: External Fan**

An external fan can be connected to baseboard. The external fan's control lines are routed via the COMe connector.

NOTICE

Additional SIO Information

COM 1 and COM 2 can be treated as 16550-compatible legacy COM interfaces at the standard I/O addresses

NOTICE

Additional CSM Information

Compatibility Support Module (CSM) configuration is important for legacy operating systems

By default, CSM is disabled for modern OS such as Windows 10 and Linux.

If a legacy OS is used or a Windows or Linux system is run in legacy mode then this menu allows for detailed option settings.

Note, a change in settings only come into effect after the next restart. Therefore, to be able to use the actualized settings, it is recommended to save and exit setup and re-enter.

The 'Optional ROM Execution' settings require special care. Any OS using an INT10 based display output needs the 'Video' option set to 'Legacy', in the same way that PXE boot needs 'Network' 'Optional ROM' to be set to 'Legacy'.

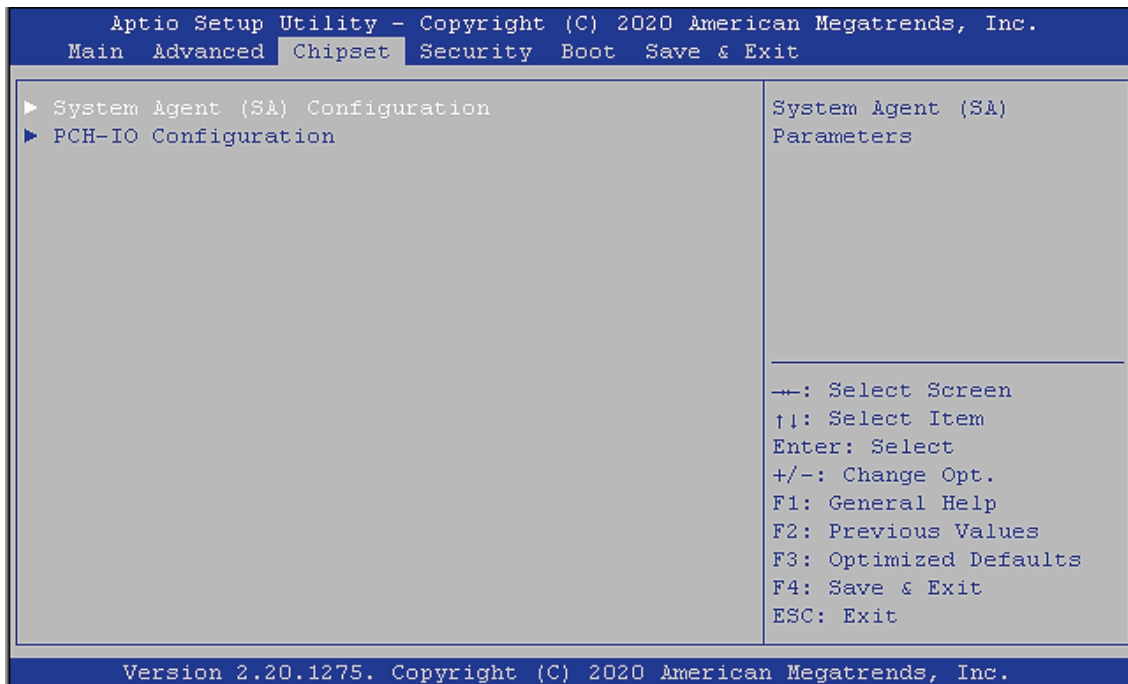
11.2.3. Chipset Setup Menu

On entering the Chipset Setup menu, the screen lists two sub-screen options:

- ▶ System Agent
- ▶ PCH-IO

Entering the System Agent Configuration and PCH-IO Configuration sub-screens provides basic system information and possible functions for these configurations.

Figure 64: Chipset Setup Menu



11.2.3.1. Chipset: System Agent Configuration

Table 23: Chipset: System Agent Configuration Sub-screens and Functions

Function	Second level Sub-Screen / Description		
Memory Configuration	Memory Test on Warm Boot	Enable/Disable	
	Maximum Memory Frequency	Auto	
	Max TOLUD	Dynamic	
	Fast Boot	Enabled/Disabled	
Graphics Configuration	Skip Scanning Slots for External Gfx Card	Enable/Disable	
	Primary Display	Auto/IGFX/PCI/SG	
	Select PCIE Card	Auto/Elk Greek 4/PEG Eval	
	External Gfx Card Primary Display Configuration		
	Internal Graphics	Auto/Disabled/Enabled	
	GTT Size	8 MB	
	Aperture Size	256 MB	
	DVMT Pre-Allocated	32 M	
	DVMT Total Gfx Mem	256 M	
		EFP1 Type	DP with HDMI/DVI
		EFP1 LSPCON	Enable/Disable
		EFP2 Type	DP with HDMI/DVI
		EFP2 LSPCON	Enable/Disable
		EFP3 Type	DP with HDMI/DVI
	EFP3 LSPCON	Enable/Disable	
PEG Port Configuration	Enable Root Port	Enabled/Disabled/Auto	
	Max Link Speed	Auto	
	PEG0 Slot Power Limit Value	75	
	PEG0 Slot Power Limit Scale	1.0x	
	PEG0/1/2 Physical Slot Number	1 (2, 3)	
	PEG0 Hotplug	Disabled/Enabled	
	Enable Root Port	Enabled/Disabled	
	Max link Speed	Auto/Gen1/Gen2/Gen3	

Function	Second level Sub-Screen / Description	
	PEG Port Feature Configuration	Detect Non Compliance Device [Enable/ Disable]
PEG Width Configuration	PEG Width Configuration	1x8+2x4 rev (for 2/4-slot riser cards) 2x8 rev (for 1-slot riser cards)
Stop Grant Configuration	Auto /Manual	
VT-d	Enabled /Disabled	
Above 4GB MMIO BIOS assignment	Enabled/ Disabled	

11.2.3.2. Chipset > PCH-IO Configuration

Table 24: Chipset Set > PCH-IO Configuration Sub-screens and Functions

Function	Second level Sub-Screen / Description		
PCI Express Configuration	Port8xh Decode	Enabled/ Disabled	
	PCI-USB Glitch W/A	Enabled/ Disabled	
	PCIe Root Port 9 (opt. NVMe)	PCI Expr. Root Port 9	Enable /Disable
		Connection Type	Slot
		ASPM8	Disabled
		PME SCI	Enable /Disable
		Hot Plug	Enable/ Disable
		PCIe Speed	Auto
		Detect Timeout	0
		Extra Bus Reserved	0
		Reserved Memory	10
		Reserved I/O	4
		ETH X102 I210 (PCIeRP13) M.2 B-2280 J18 (PCIeRP14) I/O option J32 (PCIeRP15) COMe Lane 7 (PCIeRP16) ETH X105 I210 (PCIeRP21) ETH X108 I210 (PCIeRP22) MiniPCIe J20 (PCIeRP23) M.2 B-2242 J13 (PCIeRP24)	PCI Expr. Root Port 13, 14, 15, 16, 21, 22, 23, 24
	Connection Type		Slot
	ASPM 12...23		Auto
	PME SCI		Enable /Disable
	Hot Plug		Enable/ Disable
	PCIe Speed		Auto
	Detect Timeout		0
	Extra Bus Reserved		0
	Reserved Memory		10
	Reserved I/O		4

Function	Second level Sub-Screen / Description		
SATA and RST Configuration	SATA Controller	Enable/Disable	
	SATA Mode Selection	AHCI	
		Intel RST Premium...	Enables SATA RAID <i>See also note below this table!</i>
	SATA Speed Limit	Auto/1.5/3/6 Gb/s	
	Software Feature Mask Configuration	HDD Unlock	Enable/Disable
		LED Locate	Enable/Disable
	Serial ATA Port 0, 1, 2, 3	Port 0, 1, 2, 3	Enable/Disable
		External	Enable/Disable
		Spin Up Device	Enable/Disable
SATA Device Type		Hard Disk Drive	
USB Configuration	xDCI Support	Enable/Disable	
	USB Overcurrent	Enable/Disable	
	USB Overcurrent Lock	Enable/Disable	
	USB Port Disable Override	Enable/Disable	
Security Configuration	RTC Memory Lock	Enable/Disable	
	BIOS Lock	Enable/Disable	
	Force unlock on all GPIO pads	Enable/Disable	
HD Audio Subsystem Configuration	HD Audio	Enable/Disable	
Serial IO Configuration	SPIO Controller	Enable/Disable	
PCH LAN Controller	Enable/Disable		
Wake on LAN	Enable/Disable		
Serial IRQ Mode>	Continuous		
State after G3	S0 State/S5 State		
Port 80h Redirection	LPC Bus		
Enhance Port 80h LPC Decoding	Enable/Disable		
Enable TCO Timer	Enable/Disable		
PCIe P11 SSC	[Auto, 0.0%, ...]		
SPD Write Disable	True		

NOTICE

Additional Information for PCI port

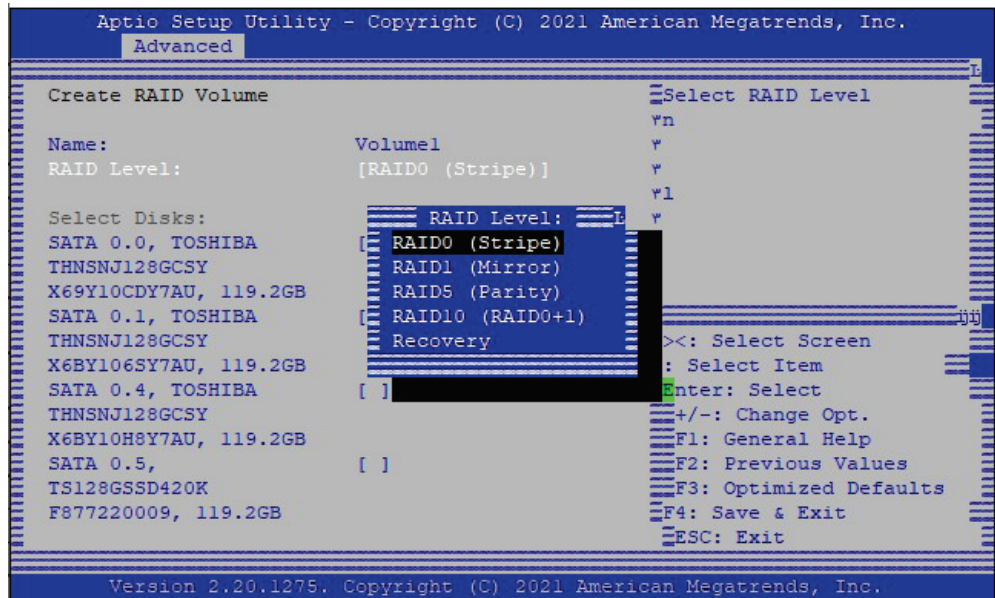
The PCIe menu refers to the different PCIe lanes using their chipset based numbers. For every lane, the number used on the COMe connector is mentioned. Take care to select the PCIe lane you require as numbering varies strongly.

The standard layout for PCIe consists of 8 PCIe 1x lanes.

Other layouts may be programmed by flashing a different descriptor to the Intel firmware on the BIOS SPI flash. Contact Kontron Support if you require different PCIe layout with your project.

NOTICE

After reboot a new menu item "Intel Rapid Storage Technology" is created in "Advanced" to configure the RAID. Depending on the amount of SATA drives RAID 0, 1, 5 or 10 are possible.



NOTICE

In case <Real Time mode> is chosen the defaults for the below settings are changed from enabled to disabled. Single items can be changed to enabled if needed.

Table 25: Setting Overview for Real Time Behaviour

No.	Requirements
01	Advanced/CPU Configuration/Hyper-Threading: Disabled
02	Advanced/Power & Performance /CPU- Power Management Control/Intel(R) Speed Step(tm): Disabled
03	Advanced/Power & Performance /CPU- Power Management Control/Inter(R) Speed Shift Technology: Disabled
04	Advanced/Power & Performance /CPU- Power Management Control/Turbo Mode: Disabled
05	Advanced/Power & Performance /CPU- Power Management Control/C-States: Disabled
06	Advanced/USB Configuration/Legacy USB Support: Disabled

11.2.4. Security Setup Menu

The Security Setup menu provides information about the passwords and functions for specifying the security settings. The passwords are case-sensitive.

Figure 65: Security Setup Menu

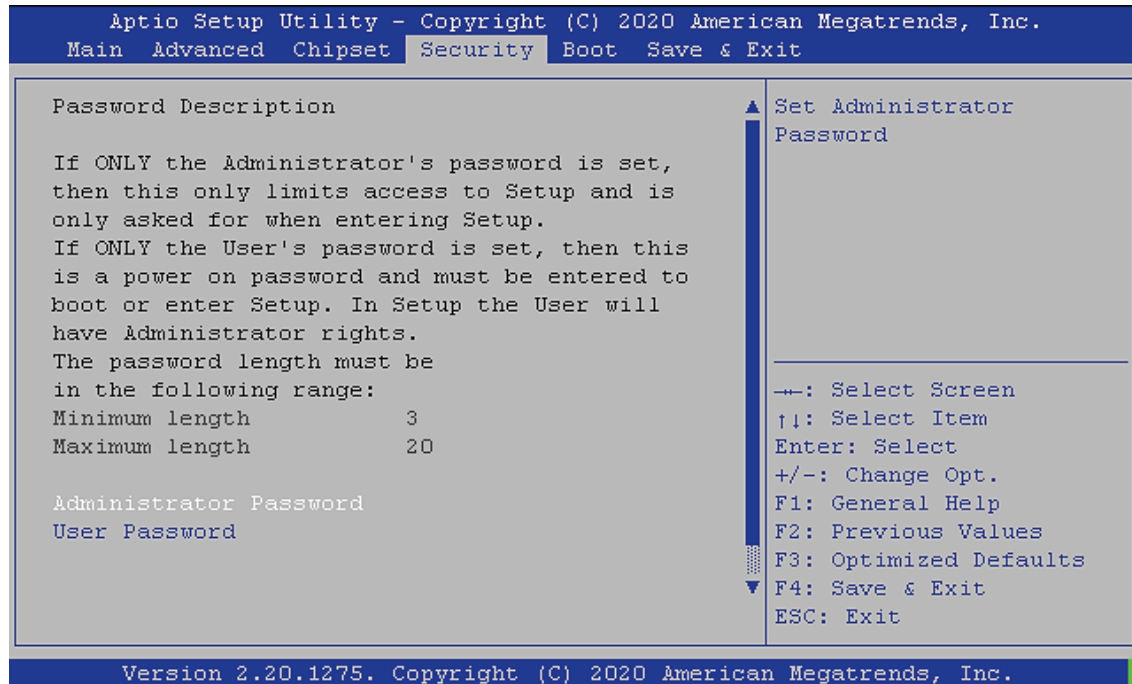


Table 26: Security Setup Menu Functions

Function	Description
Administrator Password	Sets administrator password
User Password	Sets user password



If only the administrator's password is set, then only access to setup is limited. The password is only entered when entering setup.

If only the user's password is set, then the password is a power on password and must be entered to boot or enter setup. Within the setup menu the user has administrator rights.

Password length requirements are maximum length 20 and minimum length 3.

11.2.4.1. Remember the Password

It is highly recommended to keep a record of all passwords in a safe place. Forgotten passwords results in the user being locked out of the system.

If the system cannot be booted because the User Password or the Supervisor Password are not known, see Chapter 11.5 "Updating the uEFI BIOS" for information about clearing the uEFI BIOS settings, or contact Kontron Support for further assistance.



HDD security passwords cannot be cleared using the above method.

11.2.5. Boot Setup Menu

The Boot Setup menu lists dynamically generated boot device priority order.

Figure 66: Boot Setup Menu

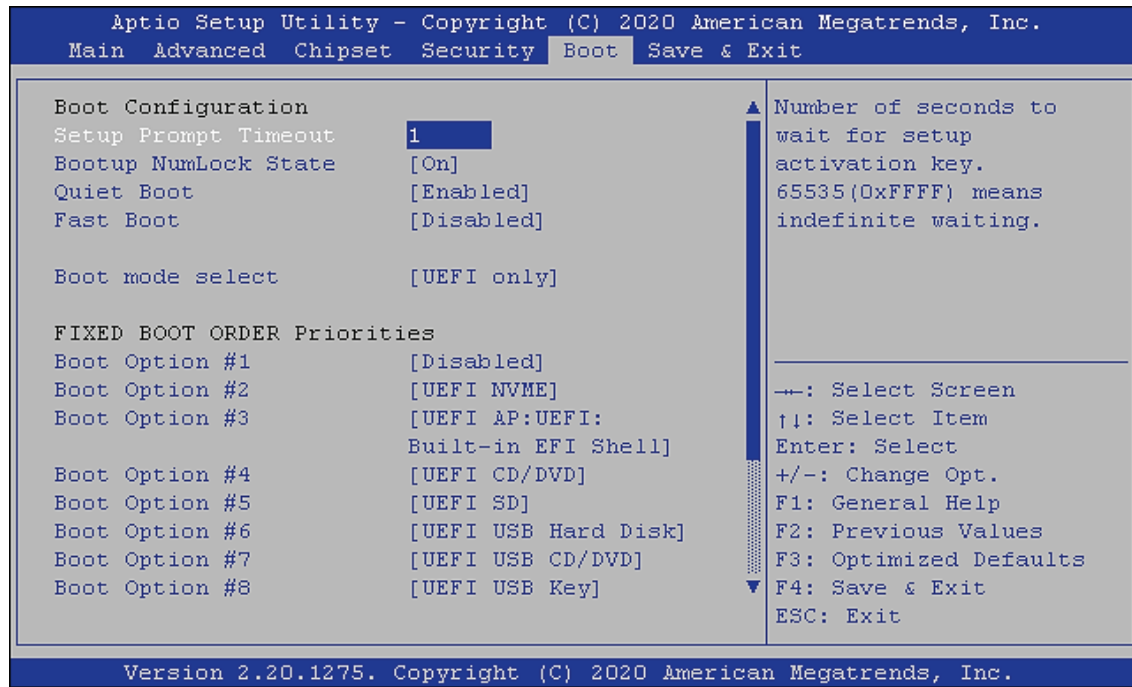


Table 27: Boot Setup Menu Functions

Function	Description
Setup Prompt Timeout	Displays number of seconds that the firmware waits before initiating the original default boot selection
Bootup NumLock State	Selects keyboard NumLock state
Quiet Boot	Enables/disables Quiet Boot
Fast Boot	Enables/disables boot with initialization of a minimal set of devices required to launch active boot option This has no effect for BBS boot options.
Boot Mode Select	Select Boot Mode LEGACY/UEFI
Boot Option #1...#12	Sets the System Boot Order
UEFI Application Boot Priorities	Specifies the Boot Device Priority Sequence from available UEFI Application

11.2.6. Save and Exit Setup Menu

The Save and Exit Setup menu provides functions for handling changes made to the uEFI BIOS settings and exiting of the Setup program.

Figure 67: Save and Exit Setup Menu

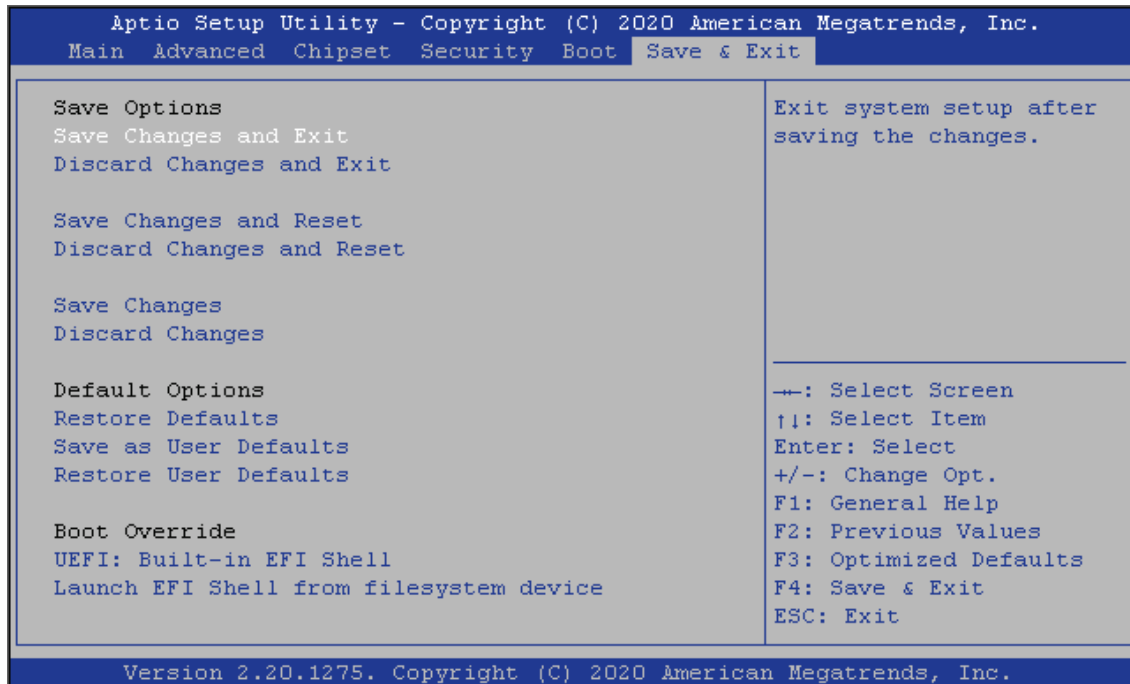


Table 28: Save and Exit Setup Menu Functions

Function	Description
Save Changes and Exit>	Exits system after saving changes
Discard Changes and Exit>	Exits system setup without saving any changes
Save Changes and Reset>	Resets system after saving changes
Discard Changes and Reset>	Resets system setup without saving any changes
Save Changes>	Saves changes made so far for any of the setup options
Discard Changes>	Discards changes made so far for any setup options
Restore Defaults>	Restores/loads standard default values for all setup options
Save as User Defaults>	Saves changes made so far as user defaults
Restore User Defaults>	Restores user defaults to all setup options
UEFI: Built-in EFI shell>	Attempts to launch the built in EFI Shell
UEFI: KingstonDataTraveler 3.0 >	Attempts to launch EFI Shell application (Shell.efi) from one of the available file system devices

11.3. The uEFI Shell

The Kontron uEFI BIOS features a built-in and enhanced version of the uEFI Shell. For a detailed description of the available standard shell scripting, refer to the EFI Shell User Guide. For a detailed description of the available standard shell commands, refer to the EFI Shell Command Manual. Both documents can be downloaded from the EFI and Framework Open Source Community homepage (<http://sourceforge.net/projects/efi-shell/files/documents/>).



Kontron uEFI BIOS does not provide all shell commands described in the EFI Shell Command Manual.

11.3.1. Basic Operation of the uEFI Shell

The uEFI Shell forms an entry into the uEFI boot order and is the first boot option by default.

11.3.1.1. Entering the uEFI Shell

To enter the uEFI Shell, follow the steps below:

1. Power on the board.
2. Press the <F7> key (instead of) to display a choice of boot devices.
3. Choose 'UEFI: Built-in EFI shell'.

```

UEFI Interactive Shell v2.2
EDKII / Kontron add-on v0.1
UEFI v2.70 (American Megatrends, 0x0005000D)
Mapping table:
  FS0:      Alias(s):HD0f0b:;BLK1:
            PciRoot(0x0)/Pci(0x14,0x0)/USB(0x5,0x0)/HD(1,MBR,0x0008131B,0x1,0x6C7ff)
  BLK0:     Alias(s):
            PciRoot(0x0)/Pci(0x14,0x0)/USB(0x5,0x0)

```

4. Press the ESC key within 5 seconds to skip startup.nsh, and any other key to continue.
5. The output produced by the device-mapping table can vary depending on the board's configuration.
6. If the ESC key is pressed before the 5 second timeout elapses, the shell prompt is shown:

```
Shell>
```

11.3.1.2. Exiting the uEFI Shell

To exit the uEFI Shell, follow one of the steps below:

1. Use the **exit** uEFI Shell command to select the boot device, in the Boot menu, for the OS to boot from.
2. Reset the board using the reset uEFI Shell command.

11.4. uEFI Shell Scripting

11.4.1. Startup Scripting

If the ESC key is not pressed and the timeout has run out then the uEFI Shell tries to execute some startup scripts automatically. It searches for scripts and executes them in the following order:

1. Initially searches for Kontron flash-stored startup script.
2. If there is no Kontron flash-stored startup script present then the uEFI-specified `startup.nsh` script is used. This script must be located on the root of any of the attached FAT formatted disk drive.
3. If none of the startup scripts are present or the startup script terminates then the default boot order is continued.

11.4.2. Create a Startup Script

Startup scripts can be created using the uEFI Shell built-in editor **edit** or under any OS with a plain text editor of your choice. To create a startup shell script, simply save the script on the root of any FAT-formatted drive attached to the system. To copy the startup script to the flash, use the **kBootScript** uEFI Shell command.

In case there is no mass storage device attached, the startup script can be generated in a RAM disk and stored in the SPI boot flash using the **kRamdisk** uEFI Shell command.

11.4.3. Examples of Startup Scripts

11.4.3.1. Execute Shell Script on Other Harddrive

This example (**startup.nsh**) executes the shell script named **bootme.nsh** located in the root of the first detected disc drive (**fs0**).

```
fs0:  
bootme.nsh
```

11.5. Updating the uEFI BIOS

The KBox C-103-CFL has two SPI boot flashes programmed with the uEFI BIOS, a standard SPI boot flash and a recovery SPI boot flash. The basic idea behind that is to always have at least one working uEFI BIOS flash available regardless if there have been any flashing errors or not.

11.5.1. Updating Procedure

For the BIOS update the customer should follow the instructions in the Readme.txt BIOS package.

11.5.2. uEFI BIOS Recovery

In case of the standard SPI boot flash being corrupted and therefore the KBox C-103-CFL-x not starting up, it can be booted from the recovery SPI boot flash via RESCUE button on the front panel. For further information, refer to the section 4.5.8 "RESCUE Button and RSQ LED".

NOTICE

The uEFI BIOS code and settings are stored in the SPI boot flashes. Changes made to the uEFI BIOS settings are available only in the currently selected SPI boot flash. Thus, switching over to the other SPI boot flash may result in operation with different uEFI BIOS code and settings.

11.5.3. Determining the Active Flash

Sometimes it may be necessary to check which flash is active. On the AMI Aptio-based uEFI BIOS, the information is available using the kboardinfo uEFI Shell command.

12/ KBox C-103-CFL CPLD Specific Registers

The system registers are accessed over the LPC bus and occupies a total of 32 bytes. The base address is set to 0x100 in order not to conflict with the usually used address space starting at 0x280.

12.1. Register Overview

Table 29: Register Overview

Offset	Register mnemonic	Register description	Category
00	STAT0	Status Register 0	CS
01		Reserved	
02	CTRL0	Control Register 0	CS
03		Reserved	
04		Reserved	
05	RSTAT	Reset Status Register	CS
06	BICFG	Board Interrupt Configuration	CS
07		Reserved	
08	BIDH	Board ID Register High Byte	ID
09	FREV	CPLD Revision Register	ID
0A	BREV	Board Revision Register	ID
0B		Reserved	
0C		Reserved	
0D	BIDL	Board ID Register Low Byte	ID
0E		Reserved	
0F		Reserved	
10	LCFG	LED Configuration Register	LED
11	LCTRL	LED Control Register	LED
12		Reserved	
13		Reserved	
14		Reserved	
15		Reserved	
16		Reserved	
17		Reserved	
18	TMPSR	Temperature Status Register	PML
19		Reserved	
1A		Reserved	
1B		Reserved	
1C		Reserved	
1D		Reserved	
1E	IDX	Index Register	IDX
1F	Data Register	Data Register	DAT

 : Register uses Reserved address space

12.2. Register Descriptions

12.2.1. Status Register 0 STAT0

Table 30: Status Register 0 STAT0

0x100	Status Register 0 STAT0							
Bit	7	6	5	4	3	2	1	0
Name	FPPB	BBEI	BFSS[1:0]		-	-	-	-
Access	R	R/WO	R		R	R	R	R
Reset PS	na	0	na		0	0	0	0

FPPB: Front Panel Power Button – This bit is derived from internal signal shaping logic formed by helper state machine PWBTON and represents current front panel power button status. A one in this bit means button is pressed for longer than 50msec.

BBEI: BIOS Boot End Indication – This bit is set by BIOS after finishing booting, cleared otherwise. After this bit is set, it cannot be cleared again by software. Clearing is done by reset events P and S.

BFSS[1:0]: Boot Flash Selections Status – This bit field indicates which Flash device is currently in use or referenced and derived from rescue logic block.

Decoding of Flash selection status:

Table 31: Decoding of Flash selection status

BFSS[1]	BFSS[0]	Flash reference
0	0	Standard SPI boot flash
0	1	Recovery SPI boot flash
1	0	Reserved
1	1	Reserved

12.2.2. Control Register 0 CTRL0

Table 32: Control Register 0 CTRL0

0x102	Control Register 0 CTRL0							
Bit	7	6	5	4	3	2	1	0
Name	-	-	BFUS	-	-	-	-	-
Access	-	-	R/W	-	-	-	-	-
Reset PS	0	0	0	0	0	0	0	0

BFUS: Boot Flash Update Selection - The active SPI boot flash will be toggled each time if bit BFUS is **written** with 0 to 1 or 1 to 0. The active SPI boot flash can be read back via the Status Register 0, bit field BFSS.



The effective selection of rescue BIOS flash is indicated by red blinking rescue LED.

12.2.3. Reset Status Register RSTAT

This register is implemented to determine the cause of system reset's or shutdown.

Table 33: Reset Status Register RSTAT

0x105	Reset Status Register RSTAT							
Bit	7	6	5	4	3	2	1	0
Name	PORS	CBRS	-	MWDTS	THRMS	0	SHDNS	RRES
Access	R/W	R/W	R	R/W	R/W	R/W	R/W	R/W
Reset P	0	0	0	0	0	0	0	0

PORS: Power On Reset Status – This bit distinguishes the cause of a system reset

0 = System reset generated by software (warm start)

1 = System reset generated by power on (cold start)

CBRS: Carrier Board Reset Status – This bit if set reports COMe module caused reset by using CB_RESET# line.

0 = CB_RESET# not generated by COMe module.

1 = CB_RESET# generated by COMe module.

MWDTS: Module Watchdog Trigger Status – This bit if set reports COMe module caused reset by watchdog signal line WDT.

0 = System reset not generated by WDT signal line.

1 = System reset generated by WDT signal line.

THRMS: Thermal Status – This bit if set reports COMe module caused reset with THRMTRIP# line asserted.

0 = THRMTRIP# not asserted by COMe module.

1 = THRMTRIP# asserted by COMe module.

SHDNS: Shutdown Status – This bit if set reports shutdown was intentional.

0 = Unexpected shutdown occurred.

1 = Shutdown executed (intentional or because of power failure)

RRES: Rescue reboot executed Status – This bit is set to inform system software reboot with rescue flash has occurred.

12.2.4. Board interrupt configuration BICFG

This control register is used to route the three individual interrupt sources to a predefined set of interrupt lines.

Table 34: Board interrupt configuration BICFG

0x106	Board interrupt configuration BICFG							
Bit	7	6	5	4	3	2	1	0
Name	-	-	PMICF [1:0]		CICF [1:0]		-	
Access	-	-	R/W		R/W		-	
Reset PS	0	0	00		00		00	

PMICF[1:0]: Power Management Interrupt Configuration - The PMICF bit field is used to select an interrupt line association for the power management interrupt requests as decoded as follows:

Table 35: Power Management Interrupt Configuration

PMICF[1]	PMICF[0]	Interrupt request line
0	0	Disabled (Default)
0	1	LPT_ACK# of Super-I/O
1	0	IRQ10
1	1	IRQ11 (Recommended)

CICF[1:0]: CAN Interrupt Configuration - The CICF bit field is used to select an interrupt line association for the CAN controller module as decoded as follows:

Table 36: CAN Interrupt Configuration

CICF[1]	CICF[0]	Interrupt request line
0	0	Disabled (Default)
0	1	IRQ5
1	0	IRQ10 (Recommended)
1	1	IRQ11

12.2.5. Board ID Register High Byte BIDH

This register contains the High byte of the Board ID.

Table 37: Board ID Register High Byte BIDH

0x108	Board ID Register High Byte BIDH							
Bit	7	6	5	4	3	2	1	0
Name	BIDH[7:0]							
Access	R							
Reset P	0xEF							

12.2.6. PLD Revision Register

Table 38: PLD Revision Register FREV

0x109	PLD Revision Register FREV							
Bit	7	6	5	4	3	2	1	0
Name	FREV [7:0]							
Access	R							
Reset P	na							

12.2.7. Board Revision Register

Table 39: Board Revision Register BREV

0x10A	Board Revision Register FREV							
Bit	7	6	5	4	3	2	1	0
Name	BREV [7:0]							
Access	R							
Reset P	0x02...							

12.2.8. Board ID Register Low Byte BIDL

This register contains the Low byte of the Board ID.

Table 40: Board ID Register Low Byte BIDL

0x10D	Board ID Register Low Byte BIDL							
Bit	7	6	5	4	3	2	1	0
Name	BIDL[7:0]							
Access	R							
Reset P	\$90							

12.2.9. LED Configuration Register LCFG

The LED Configuration Register holds a series of bits defining the onboard configuration for the front panel General Purpose LEDs.

Table 41: LED Configuration Register LCFG

0x110	LED Configuration Register LCFG							
Bit	7	6	5	4	3	2	1	0
Name	-	-	-	-	LCON			
Access	-	-	-	-	R/W			
Reset PS	0	0	0	0	%0000			

LCON[3:0]: User-Specific LED Configuration – This bit field selects the LED Configuration mode. The default setting after power up is POST mode.

0000 = POST

0001 = Reserved

0010 = Mode B (default after Boot)

remaining = Reserved

In POST mode all eight LED's will display POST code during the pre-boot phase. Mode B is used for display of general purpose informations.

12.2.10. LED Control Register LCTRL

This register can be read and written to any time and is used to drive the front panel General Purpose LEDs.

Table 42: LED Control Register LCTRL

0x111	LED Control Register LCTRL							
Bit	7	6	5	4	3	2	1	0
Name	LCMD				LCOL			
Access	R/W				R/W			
Reset PS	%0000				%0000			

The status of a certain LED can be get by writing a get LED command including LED number (color bits are ignored) followed by a simple read.

LCMD[3:0]: LED command – This bit field is used to get and set a certain LED status.

0000 = Get LED 0
 0001 = Get LED 1
 0010 = Get LED 2
 0011 = Get LED 3
 01xx = Reserved
 1000 = Set LED 0
 1001 = Set LED 1
 1010 = Set LED 2
 1011 = Set LED 3
 11xx = Reserved

LCOL[3:0]: LED color – This bit field is used to define the color of the LED specified together with .the SET command.

0000 = Off
 0001 = Green
 0010 = Red
 0011 = Red + Green
 01xx = Reserved

12.2.11. Temperature Status Register TMPSR

This read only status register is used to get status of both the onboard temperature sensor and the FAN implementation.

Table 43: Temperature Status Register TMPSR

0x118	Temperature Status Register TMPSR							
Bit	7	6	5	4	3	2	1	0
Name	-	-	-	-	OVT	FDIAG	FTAS	FPWM
Access	-	-	-	-	R	R	R	R
Reset PS	0	0	0	0	na	na	0	0

OVT: Over temperature – This status bit is used to get the current status OVER_T# of onboard temperature sensor LM73.

0 = Temperature within range

1 = LM73 detected temperature higher than present limit.

FDIAG: Fan Diagnostic – This status bit is defined DIP switch #5 and enables logic for fan diagnostics (analysis of FAN tacho pin)

0 = Fan diagnostic disabled

1 = Fan diagnostic enabled

FTAS: Fan tacho status – This status bit indicates if fan is working correctly by analysis of fan tacho input signal FAN_TACHO. This analysis is only done if FDIAG is set and the fan is activated (indicated by FPWM is set, too).

0 = Not active, fan maybe defective.

1 = Fan tacho pulses detected

FPWM: Fan PWM status – This status bit is based on activity on input signal FAN_PWM_OUT and informs if fan is generally activated.

0 = Fan not active

1 = Fan active (Duty cycle greater than 0)

12.2.12. Index Register IDX

This register is a pointer to extended registers.

Table 44: Index Register IDX

0x11E	Index Register IDX							
Bit	7	6	5	4	3	2	1	0
Name	SEM	IDX [6:0]						
Access	R/W	R/W						
Reset PS	0	\$00						

SEM: This bit is used for simple semaphore operation. Reading Index Register sets this bit to '1'. It can be clear to '0' by writing '1' to it.

IDX: 7-bit address of extended register

12.2.13. Data Register DATA

This register is used to access extended registers. Reading or writing to this register generates read or write cycle to register pointed by IDX.

Table 45: Data Register DATA

0x11F	Data Register DATA							
Bit	7	6	5	4	3	2	1	0
Name	DATA [7:0]							
Access	R/W							
Reset PS	-							

12.3. Extended Registers

Extended registers are accessed by read/write cycle to DATA register. The IDX register must be initialized prior to DATA access.

12.3.1. DIP switch Status Register DIPSW

This read only register shows status of 6-position DIP Switch and Jumper JP0/JP1.

Table 46: DIP switch Status Register DIPSW

IDX=0X03	DIP switch Status Register DIPSW							
Bit	7	6	5	4	3	2	1	0
Name	JP[1:0]		DIPSW					
Access	R		R					
Reset PS								

JP[1:0]: Status of Jumper.

0 = Jumper is off (removed)

1 = Jumper is set (present).

DIPSW[5]: Enable or disable FAN diagnostic

0 = FAN diagnostic is OFF.

1 = FAN diagnostic is ON

DIPSW[4]: Used for automatic BIOS PEG port bifurcation

0 = PEG width Configuration [2x8 Rev]

1 = PEG width Configuration [1x8+2x4 Rev]

DIPSW[3:0]: For user applications.

Note: '0' = switch OFF; '1' = switch ON

BIT 0 reflects status of switch number 1

.....

BIT 5 reflects status of switch number 6

13/ Technical Specifications

Table 47: Technical Specifications

KBox C-103-CFL Family				
Installed COM Express Module and Baseboard	Baseboard with COMe-bCL6 G4930E or Baseboard with COMe-bCL6 i3-9100HL or Baseboard with COMe-bCL6 i5-8400H or Baseboard with COMe-bCL6 i7-9850HE or Baseboard with COMe-bCL6 E-2276ME			
Processor	Intel® Celeron™ G4930E, 2x 2.4GHz, 35W max. power consumption Intel® Core™ i3-9100HL, 4x1.6GHz, 25W max. power consumption Intel® Core™ i5-8400H, 4x 2.5GHz, 45W max. power consumption Intel® Core™ i7-9850HE, 6x 2.7GHz, 45W max. power consumption Intel® XEON™ E-2276ME, 6x 2.8GHz, 45W max. power consumption			
RAM	Up to 64 GB w/wo ECC			
BIOS	AMI Aptio V uEFI			
Controls (at the front side)	Power button (PWR) RESCUE button (RSQ)			
Indicators (at the front side)	PWR (Power LED) RSQ (Rescue LED) TH (Thermal LED) DR (HDD/SSD status LED) M2 (M.2 Card status LED) WD (Watchdog status LED) GP1-4 (General purpose LEDs)			
Interfaces (front side accessible)	4x Ethernet (10/100/1000 Mbit/s) 3x USB 3.0 3x USB 2.0 2x DisplayPort 1x Serial port (RS232/RS422/RS485)			
DC IN Connector (at the front side)	3-pin DC input connector			
Protection Class	IP20			
Lithium Battery (Option) (internally accessible)	CR 2032, 3 V			
Rated Voltage (tolerance)	24 VDC/6 A (+20% / - 20%), up to 20ms hold-up (depending on configuration)			
	KBox C-103-CFL-4	KBox C-103-CFL-2	KBox C-103-CFL-1	KBox C-103-CFL-0
Options for Storage Media	2x 2.5" SATA HDD/SSD non removable or 2x 2.5" removable SATA HDD/SSD for: • DRIVE 1: SATA 6 Gb/s. • DRIVE 2: SATA 6 Gb/s. Up to 2x M.2 1x MicroSD card	2x 2.5" SATA HDD/SSD non removable or 2x 2.5" removable SATA HDD/SSD for: • DRIVE 1: SATA 6 Gb/s. • DRIVE 2: SATA 6 Gb/s. Up to 2x M.2 1x MicroSD Card	1x 2.5" SATA HDD/SSD non removable or 1x 2.5" removable SATA HDD/SSD for: • DRIVE 1: SATA 6 Gb/s. Up to 2x M.2 1x MicroSD Card	1x 2.5" SATA HDD/SSD non removable Up to 2x M.2 1x MicroSD Card

KBox C-103-CFL Family				
Free Expansions Sockets (internal)	1x M.2 B-type 1x full/half size Mini PCIe x1 2x PCIe x4 and 2x PCIe x1	1x M.2 B-type 1x full/half size Mini PCIe x1 2x PCIe x4 or 1x PCIe x8 or 1x PCI (32 bit) and 1x PCIe x4 (via corresponding riser card)	1x M.2 B-type 1x full/half size Mini PCIe x1 1x PCIe x4 or 1x PCIe x8 (via corresponding riser card)	1x M.2 B-type 1x full/half size Mini PCIe x1
Fan Tray (Option)	yes	yes	yes	no

13.1. Mechanical Specifications of the KBox C-103-CFL

13.1.1. Mechanical Specifications of the KBox C-103-CFL-4

Figure 68: Dimensions: right side (KBox C-103-CFL-4)

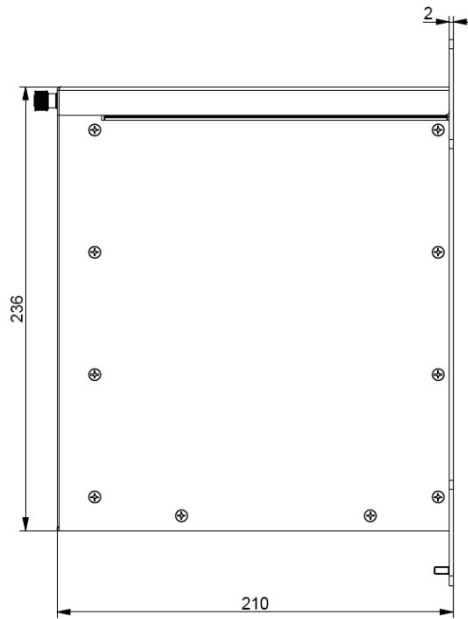


Figure 69: Dimensions: front side with key holes (KBox C-103-CFL-4)

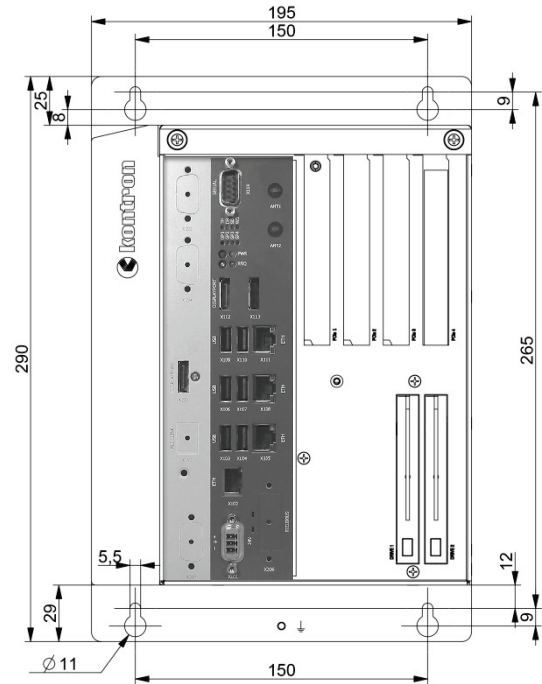
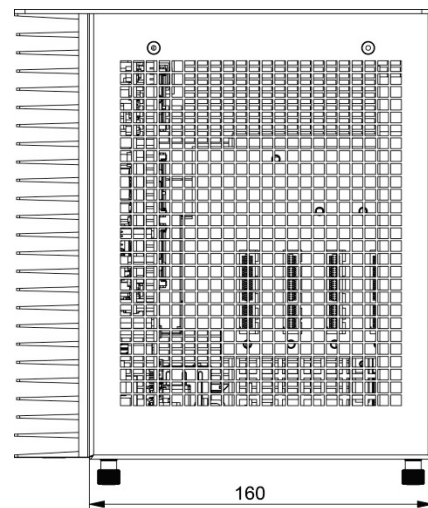
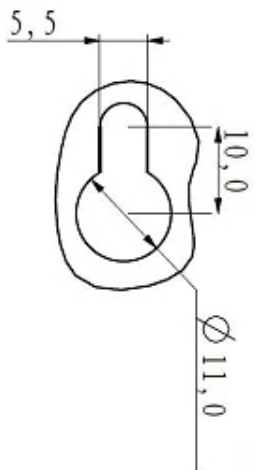


Figure 70: Dimensions: detail key hole (KBox C-103-CFL-4)

Figure 71: Dimensions: top side (KBox C-103-CFL-4)



13.1.2. Mechanical Specifications of the KBox C-103-CFL-4 with Fan Tray Option

Figure 72: Dimensions: right side
(KBox C-103-CFL-4 with fan tray option)

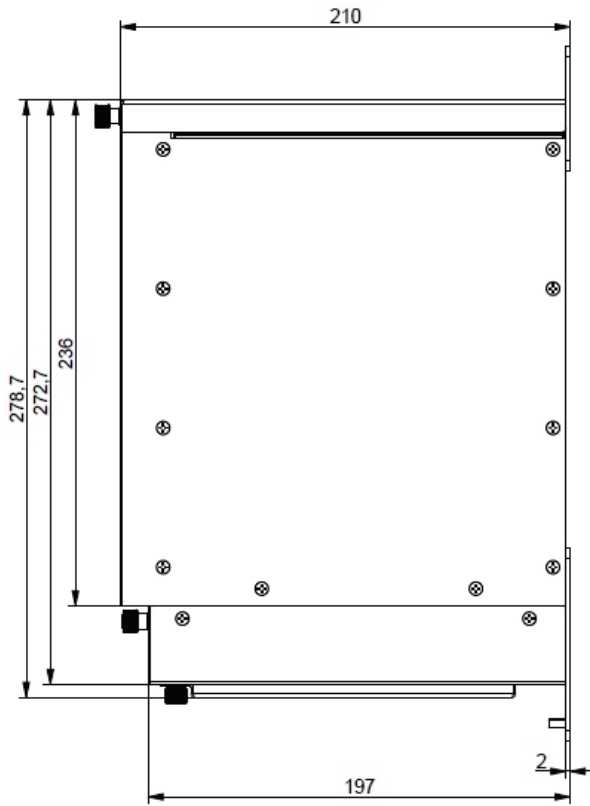


Figure 73: Dimensions: front side with key holes
(KBox C-103-CFL-4 with fan tray option)

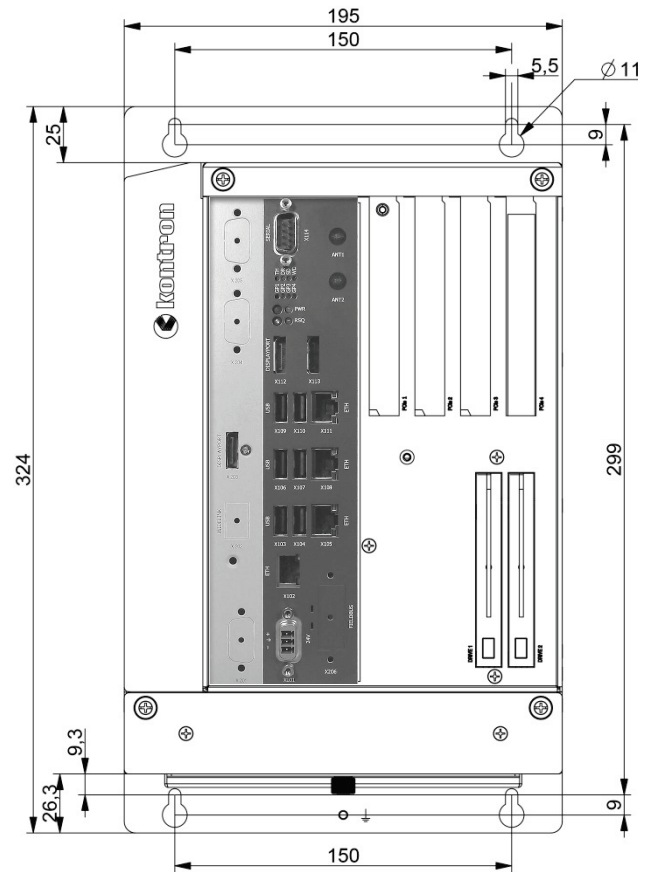


Figure 74: Dimensions: detail key hole
(KBox C-103-CFL-4 with fan tray option)

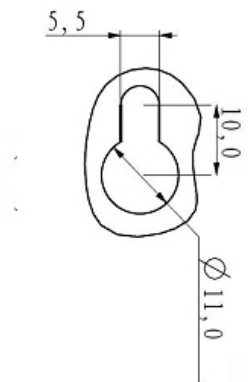


Figure 75: Dimensions: top side
(KBox C-103-CFL-4 with fan tray option)

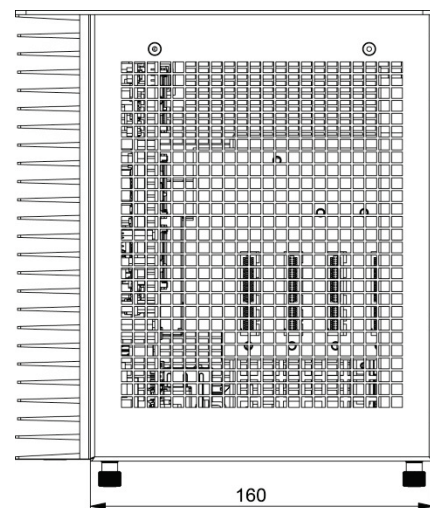


Table 48: Mechanical Specifications of the KBox C-103-CFL-4

Dimensions	KBox C-103-CFL-4 (Standard Version)	KBox C-103-CFL-4 (with optional Fan Tray)
Height	with mounting brackets: 290 mm (11.42")	with mounting brackets: 324 mm (12.756")
Width	195 mm (6.10")	195 mm (6.10")
Depth	with mounting brackets: 210 mm (8.26")	with mounting brackets: 210 mm (8.26")
Weight (without packaging, without expansions)	Approx. 5.2 kg (9.25 lbs.)	Approx. 6.00 kg (13.22 lbs.)
Chassis	Cooling fins, black Chassis: steel sheet, light grey (RAL 7035) Side with External Interfaces : trim strips, traffic grey (RAL 7043)	

13.1.3. Mechanical Specifications of the KBox C-103-CFL-2

Figure 76: Dimensions: right side (KBox C-103-CFL-2)

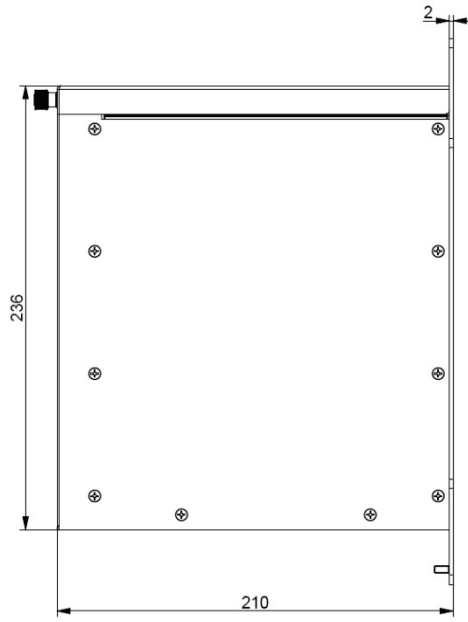


Figure 77: Dimensions: front side with key holes (KBox C-103-CFL-2)

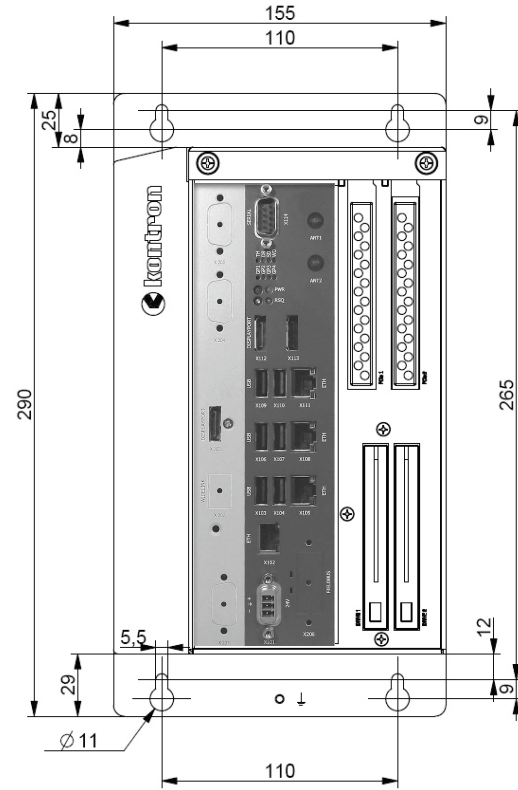
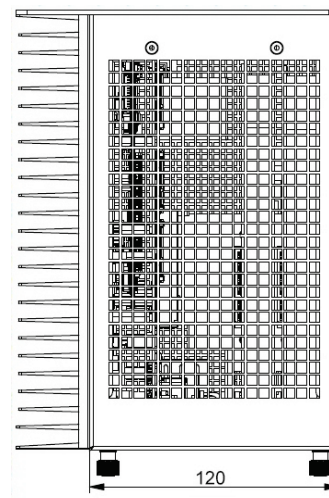
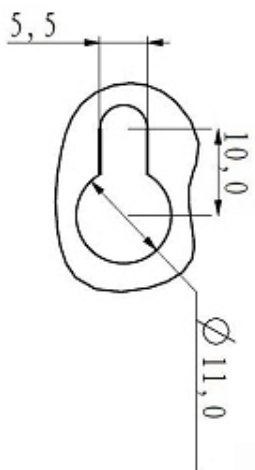


Figure 78: Dimensions: detail key hole (KBox C-103-CFL-2)

Figure 79: Dimensions: top side (KBox C-103-CFL-2)



13.1.4. Mechanical Specifications of the KBox C-103-CFL-2 with Fan Tray Option

Figure 80: Dimensions: right side
(KBox C-103-CFL-2 with fan tray option)

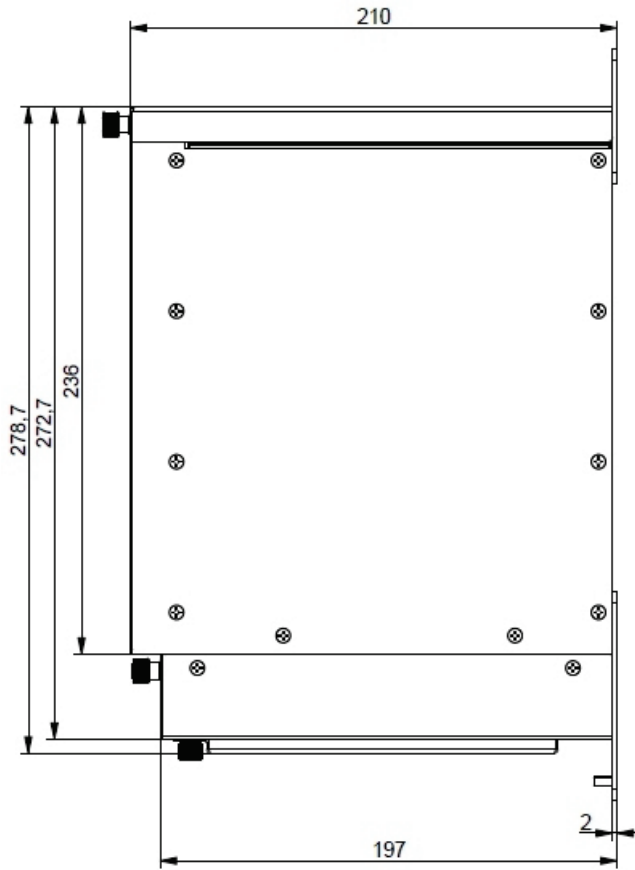


Figure 82: Dimensions: detail key hole
(KBox C-103-CFL-2 with fan tray option)

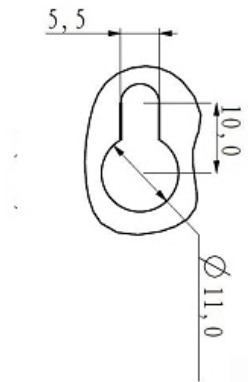


Figure 81: Dimensions: front side with key holes
(KBox C-103-CFL-2 with fan tray option)

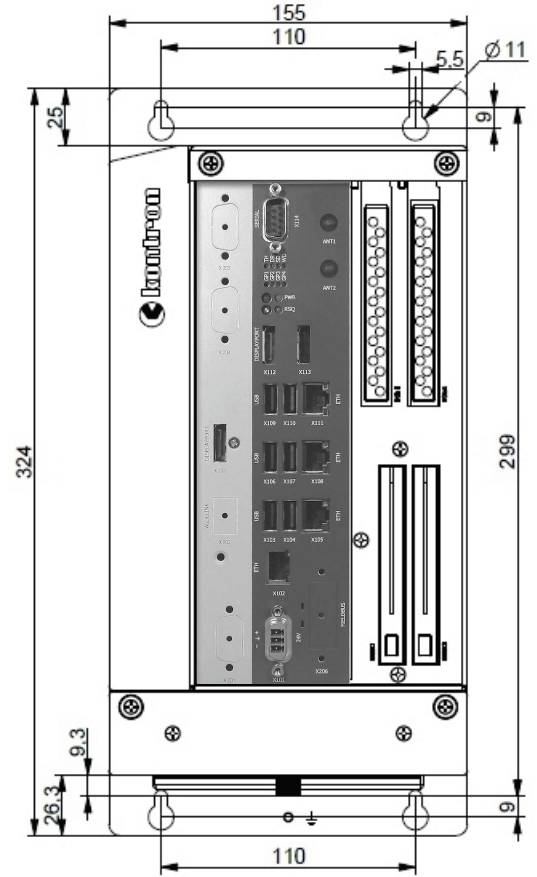


Figure 83: Dimensions: top side
(KBox C-103-CFL-2 with fan tray option)

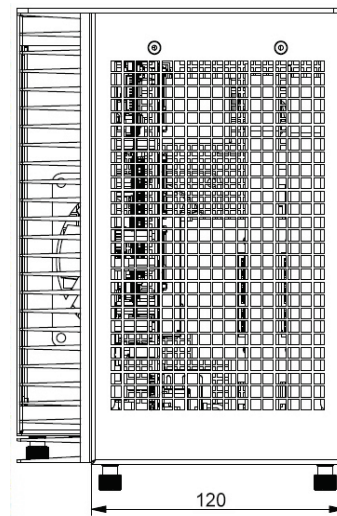


Table 49: Mechanical Specifications of the KBox C-103-CFL-2

Dimensions	KBox C-103-CFL-2 (Standard Version)	KBox C-103-CFL-2 (with optional Fan Tray)
Height	with mounting brackets: 290 mm (11.42")	with mounting brackets: 324 mm (12.756")
Width	155 mm (6.10")	155 mm (6.10")
Depth	with mounting brackets: 210 mm (8.26")	with mounting brackets: 210 mm (8.26")
Weight (without packaging, without expansions)	Approx. 4.75 kg (10.47 lbs.)	Approx. 6.00 kg (13.22 lbs.)
Chassis	Cooling fins, black Chassis: steel sheet, light grey (RAL 7035) Side with External Interfaces : trim strips, traffic grey (RAL 7043)	

13.1.5. Mechanical Specifications of the KBox C-103-CFL-1

Figure 84: Dimensions: right side (KBox C-103-CFL-1)

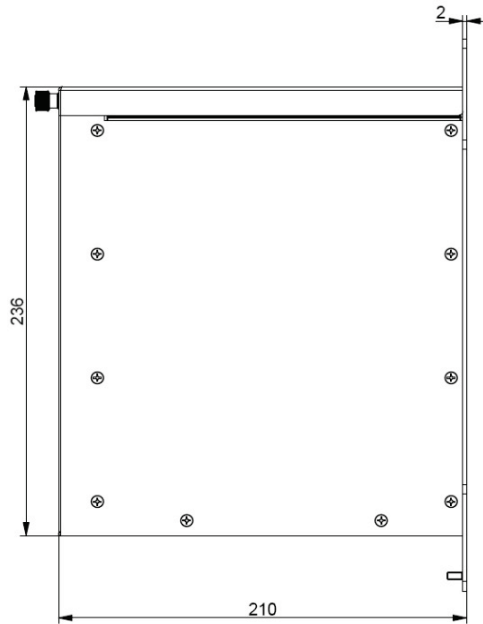


Figure 85: Dimensions: front side with key holes (KBox C-103-CFL-1)

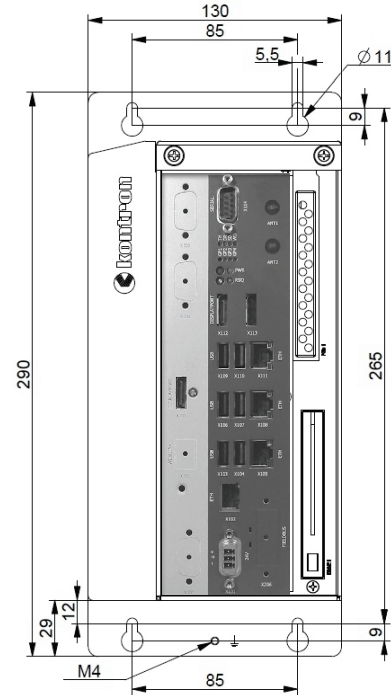


Figure 86: Dimensions: detail key hole (KBox C-103-CFL-1)

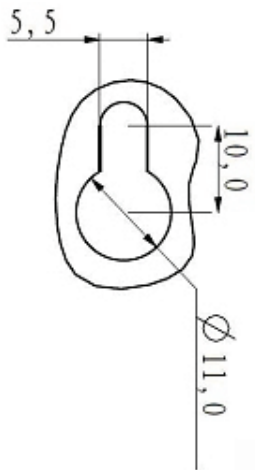
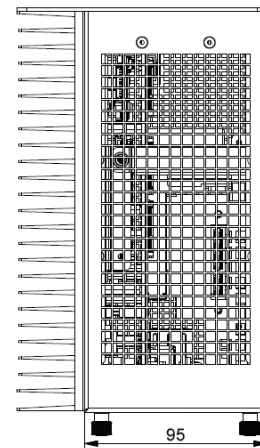


Figure 87: Dimensions: top side (KBox C-103-CFL-1)



13.1.6. Mechanical Specifications of the KBox C-103-CFL-1 with Fan Tray Option

Figure 88: Dimensions: right side
(KBox C-103-CFL-1 with fan tray option)

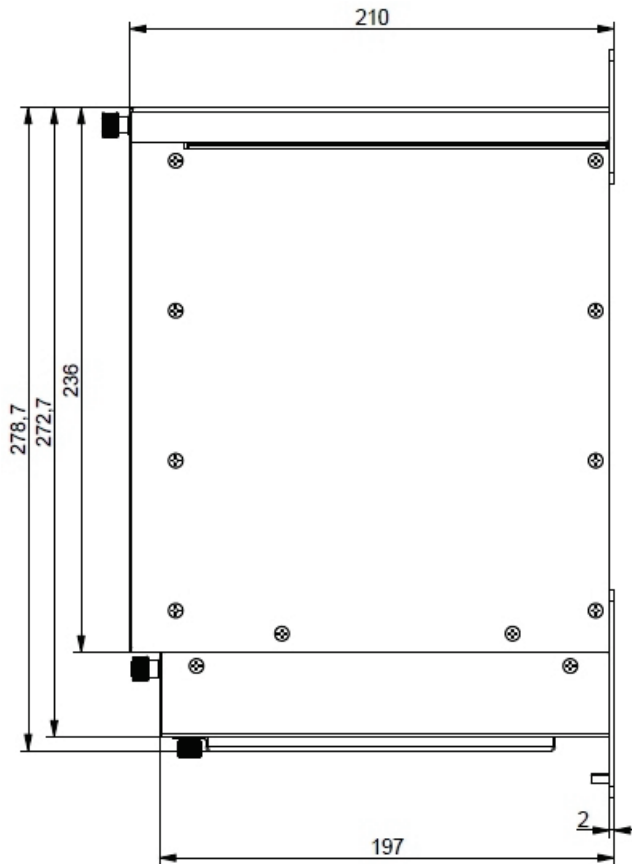


Figure 89: Dimensions: front side with key holes
(KBox C-103-CFL-1 with fan tray option)

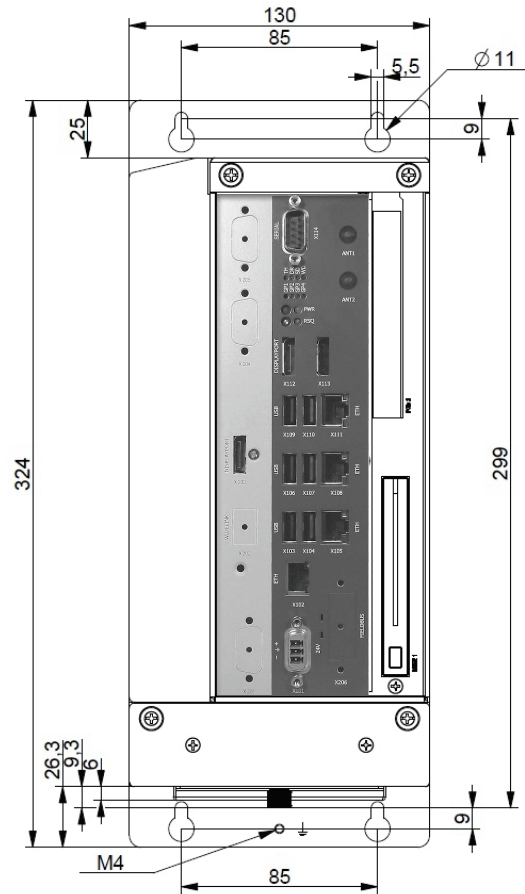


Figure 90: Dimensions: detail key hole
(KBox C-103-CFL-1 with fan tray option)

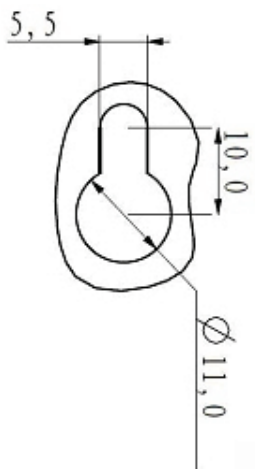


Figure 91: Dimensions: top side
(KBox C-103-CFL-1 with fan tray option)

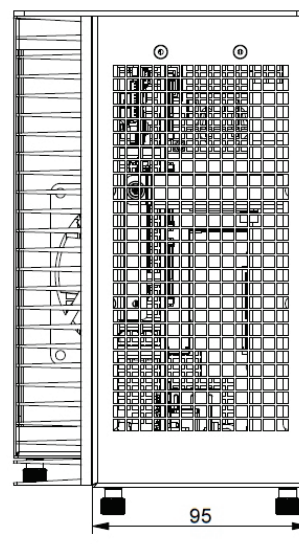


Table 50: Mechanical Specifications of the KBox C-103-CFL-1

Dimensions	KBox C-103-CFL-1 (Standard Version)	KBox C-103-CFL-1 (with optional Fan Tray)
Height	with mounting brackets: 290 mm (11.42")	with mounting brackets: 324 mm (12.756")
Width	130 mm (5.12")	130 mm (5.12")
Depth	with mounting brackets: 210 mm (8.26 ")	with mounting brackets: 210 mm (8.26 ")
Weight (without packaging, without expansions)	Approx. 4.6 kg (10.14 lbs.)	Approx. 5.6 kg (12.34 lbs.)
Chassis	Cooling fins, black Chassis: steel sheet, light grey (RAL 7035) Side with External Interfaces : trim strips, traffic grey (RAL 7043)	

13.1.7. Mechanical Specifications of the KBox C-103-CFL-0

Figure 92: Dimensions: right side (KBox C-103-CFL-0)

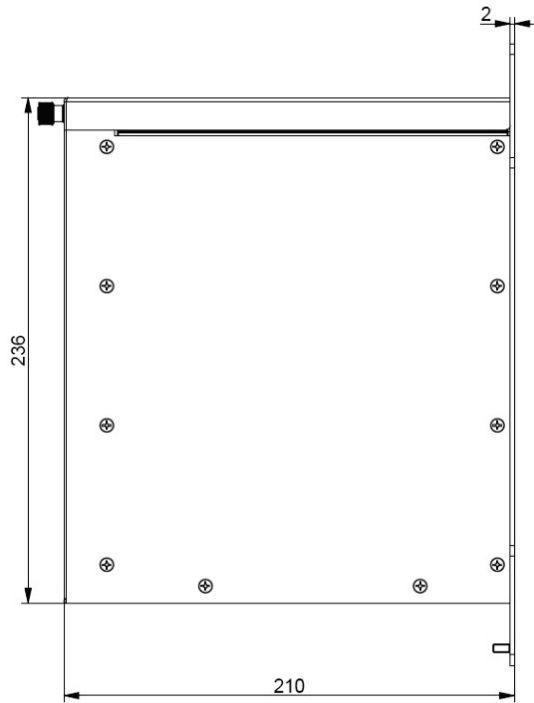


Figure 93: Dimensions: front side with key holes (KBox C-103-CFL-0)

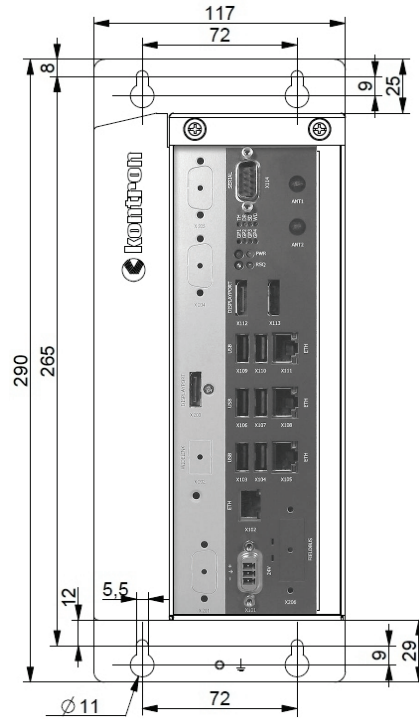


Figure 94: Dimensions: detail key hole (KBox C-103-CFL-0)

Figure 95: Dimensions: top side (KBox C-103-CFL-0)

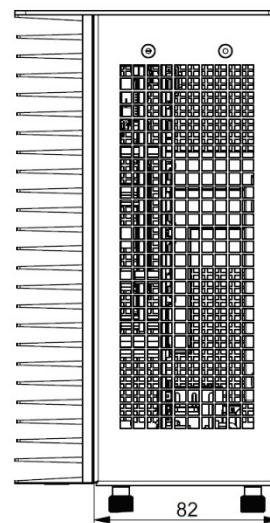
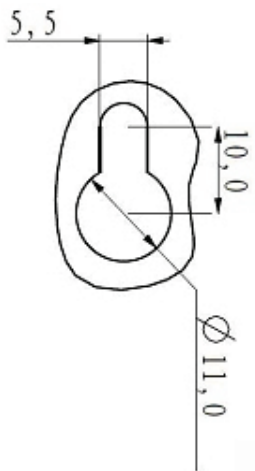


Table 51: Mechanical Specifications of the KBox C-103-CFL-0

Dimensions	KBox C-103-CFL-0 (Standard Version)
Height	with mounting brackets: 290 mm (11.42")
Width	117 mm (4.61")
Depth	with mounting brackets: 210 mm (8.26 ")
Weight (without packaging, without expansions)	Approx. 3.8 kg (8.37 lbs)
Chassis	Cooling fins, black Chassis: steel sheet, light grey (RAL 7035) Side with External Interfaces : trim strips, traffic grey (RAL 7043)

13.2. Environmental Specifications

Table 52: Environmental Specifications

	KBox C-103-CFL
Thermal Management	Convection cooling/with fan
Operating Temperature (with Fan Tray)	Intel® Celeron™ G4930E: 0°C to +70°C (32°F to 158°F) Intel® Core™ i3-9100HL: 0°C to +70°C (32°F to 158°F) Intel® Core™ i5-8400H: 0°C to +70°C (32°F to 158°F) Intel® Core™ i7-9850HE: 0°C to +65°C (32°F to 149°F) Intel® XEON™ E-2276ME: 0°C to +60°C (32°F to 140°F)
Operating Temperature (w/o Fan Tray)	Intel® Celeron™ G4930E: 0°C to +65°C (32°F to 149°F) Intel® Core™ i3-9100HL: 0°C to +65°C (32°F to 149°F) Intel® Core™ i5-8400H: 0°C to +65°C (32°F to 149°F) Intel® Core™ i7-9850HE: 0°C to +60°C (32°F to 140°F) Intel® XEON™ E-2276ME: 0°C to +55°C (32°F to 131°F)
Storage / Transit Temperature	-40°C ... +75°C (-40°F ... +167°F)
Relative Humidity (Operating)	93 % @ 40 °C (non condensing) acc. to IEC 60068-2-78
Max. Operation Altitude	2,000 m (6,560 ft.)
Max. Storage / Transit Altitude	10,000 m (32,810 ft.)
Non-Operating Shock	30 G, 11 ms, half sine, acc. to IEC 60068-2-27
Operating Shock	15 G, 11 ms, half sine, acc. to IEC 60068-2-27
Non-Operating Vibration	10 Hz - 150 Hz, 2 G, acc. to IEC 60068-2-6
Operating Vibration	10 Hz - 150 Hz, 1 G, acc. to IEC 60068-2-6
Pollution Degree	2

13.3. Standards, Certifications and Directives Compliance

Table 53: Standards, Certifications and Directives Compliance

CE-Mark Compliant with EU Directives	Electromagnetic Compatibility	Directive 2014/30/EU
	Low Voltage	Directive 2014/35/EU
	Radio Equipment Directive (RED)	Directive 2014/53/EU
	RoHS II	Directive 2011/65/EU
EMC 2014/30/EU Emission	CISPR 11 EN 55011	Industrial, scientific and medical equipment - Radio-frequency disturbance characteristics - Limits and methods of measurement
EMC 2014/30/EU Immunity	EN 61000-6-2	Electromagnetic compatibility (EMC), part 6-2: Generic standards- Immunity for industrial environment
RED 2014/53/EU <i>Article 3.1(b)</i>	EN 301 489-1 V2.2.0	ElectroMagnetic Compatibility (EMC) standard for radio equipment and services; Part 1: Common technical requirements; Harmonised Standard covering the essential requirements of article 3.1(b) of Directive 2014/53/EU and the essential requirements of article 6 of Directive 2014/30/EU
	<i>EN 301 489-17 V3.1.1</i>	ElectroMagnetic Compatibility (EMC) standard for radio equipment and services; Part 17: Specific conditions for Broadband Data Transmission Systems; Harmonised Standard covering the essential requirements of article 3.1(b) of Directive 2014/53/EU
	<i>EN 301 893 V2.1.1</i>	5 GHz RLAN; Harmonised Standard covering the essential requirements of article 3.2 of Directive 2014/53/EU
RF Spectrum Efficiency & Spurious Emission 2014/53/EU <i>Article 3.2</i>	EN 300 328 V2.1.1	Wideband transmission systems; Data transmission equipment operating in the 2,4 GHz ISM band and using wide band modulation techniques; Harmonised Standard covering the essential requirements of article 3.2 of Directive 2014/53/EU
	<i>EN 301 511 V12.5.1</i>	<i>Global System for Mobile communications (GSM); Mobile Stations (MS) equipment; Harmonised Standard covering the essential requirements of article 3.2 of Directive 2014/53/EU</i>
	EN 301 908-1 V11.1.1	<i>IMT cellular networks; Harmonised Standard covering the essential requirements of article 3.2 of the Directive 2014/53/EU; Part 1: Introduction and common requirements</i>
	<i>EN 301 908-2 V11.1.2</i>	<i>IMT cellular networks; Harmonised Standard covering the essential requirements of article 3.2 of Directive 2014/53/EU; Part 2: CDMA Direct Spread (UTRA FDD) User Equipment (UE)</i>
	<i>EN 301 908-13 V11.1.2</i>	<i>IMT cellular networks; Harmonised Standard covering the essential requirements of article 3.2 of Directive 2014/53/EU; Part 13: Evolved Universal Terrestrial Radio Access (E-UTRA) User Equipment (UE)</i>
FCC CFR 47 Part 15, Subpart B	ANSI C63.4 CISPR 16 ICES-003	The American National Standards Institute standard ANSI C63.4 is the key standard for measuring electrical and electronic equipment for showing compliance to FCC and Industry Canada regulations.

Safety 2014/35/EU	IEC 61010-1 EN 61010-1 UL 61010-1	Safety requirements for electrical equipment for measurement, control and laboratory use - Part 1: General requirements
	IEC 61010-2-201 EN 61010-2-201 UL 61010-2-201	Safety requirements for electrical equipment for measurement, control and laboratory use - Part 2-201: Particular requirements for control equipment
Safety and Health 2014/35/EU 2014/53/EU <i>Article 3.1(a)</i>	EN 62311	Assessment of the compliance of low power electronic and electrical equipment with the basic restrictions related to human exposure to electromagnetic fields (10 MHz to 300 GHz)
WEEE 2002/96/EC	The Waste Electrical and Electronic Equipment Directive (WEEE Directive)	Compliant with the Waste Electrical and Electronic Equipment (WEEE) directive to reduce waste of electrical and electronic equipment, encourage recycling and environmental disposal and increase the environmental awareness of producers

Table 54: Electrical Safety

Electrical Safety	Harmonized Standards
EUROPE	EN 61010-2-201
U.S.A. / CANADA	Conform UL 61010-1, UL 61010-2-201 Certified to CAN/CSA-C22.2 No. 61010-1-12, CSA C22.2 No. 61010-2-201:18
CB Report	IEC 61010-1:2010/AMD1:2016/COR1:2019 IEC 61010-2-201:2017
Listed Mark	UL

Table 55: EMC

EMC	Harmonized Standards
EU	Generic standards - Emission standard for industrial environments (Emission): EN 55011, Class B (conducted Emission) EN 55032, Class B EN 61000-6-4 Generic standards - Immunity for industrial environments (Immunity): EN 55024, EN 61000-6-2, EN 61000-4-3 EN61131-2 (Standard for programmable controllers, part 2 equipment requirements and tests)

13.4. Power Supply Specification

Before connecting the product to a mains power supply, ensure that the power supply meets the required electrical specification for the product and that protection and supply limitation have been taken into consideration. The power supply used must also automatically recover from AC power loss and start up under peak loading.

Connect the product only to a power supply designed to achieve NEC Class-2 and Limited Power Source (LPS).

Table 56: KBox C-103-CFL-x Electrical Specification

Nominal Input Voltage	24 VDC
Input Voltage Range	17 VDC to 36 VDC
Input Current	6.0 A max.
Inrush Current	10 A max. (at 17 VDC)
Power	140 W (max.)

⚠ CAUTION

Observed that wiring and short-circuit/overcurrent protection is performed according to the applicable standards, regulations and in respect to the product's electrical specification. The disconnecting device (fuse/circuit breaker) rating must be in accordance with the product's wire cross-section

NOTICE

Only connect to an external power supply delivering the specified input rating and complying with the requirements of Safety Extra Low Voltage (SELV) and Limited Power Source (L.P.S.) of UL/IEC 60950-1 or (PS2) of UL/IEC 62368-1.

NOTICE

Ensure that the power supply is used according to the manufacturer's instructions.

NOTICE

Ensure the power supply has been fully tested to at least meet the minimum immunity of AC inputs requirements, as stipulated in IEC 55024. Including power supplies marketed with a separate AC/DC power converter.

13.4.1. Power Supply Protection Requirements

The used external power supply is required to incorporate protection and supply features such as over current protection, inrush current protection, over voltage protection and undervoltage (brownout) protection, to protect the product against fluctuations and interruptions in the delivered DC power supply.

NOTICE

If an under voltage (brownout) condition occurs, the used power supply must remain in the "off state" long enough to allow internal voltages to discharge sufficiently. Failure to observe this "off state" may mean that parts of the product or peripherals work incorrectly or suffer a reduction of MTBF. The minimum "off state", to allow internal voltages to discharge sufficiently, is dependent on the power supply and additional electrical factors. To determine the required "off state", each case must be considered individually. For more information, contact Kontron Support.

13.4.2. Power Consumption

The used external power supply must be capable of delivering the product with the required power when configured with all components. The total power consumption depends on factors such as the CPU, interfaces, and system/memory expansion.



The external power supply must supply power to all configured components.

13.4.3. Protective Earth Stud Bolt

The protective earth stud bolt connects to the internal chassis GND. The protective earth stud bolt is located at the bottom of the System.

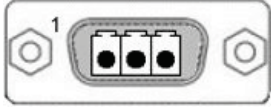
When installing cables to the product the first cable connection must be to the protective earth stud bolt and when disconnecting the last cable to be disconnected must be from the protective earth stud bolt

14/ Standard Interfaces – Pin Assignments

Low-active signals are indicated by a minus sign.

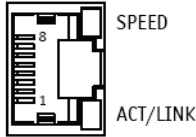
14.1.1. (X101) Power Input Connector

Table 57: (X101) Power Input Connector

Pin	Signal Name	3-pin POWER SUBCON (male)
1	+24 VDC (input)	
2	Ground	
3	0V (input)	

14.1.2. (X102, X105, X108, X111) Ethernet Connectors

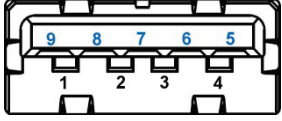
Table 58: (X102, X105, X108, X111) Ethernet Connectors

Pin	Signal Name	X102, X105, X108, X111 Ethernet (RJ45)
1	MDI0+	
2	MDI0-	
3	MDI1+	
4	MDI2+	
5	MDI2-	
6	MDI1-	
7	MDI3+	
8	MDI3-	

Speed (Mbps)		LINK/ACT	
		LINK	ACTIVE
10	off	on	orange on (blinking)
100	green	on	orange on (blinking)
1000	orange	on	orange on (blinking)


14.1.3. (X103, X106, X109) USB 3.0 Ports

Table 59: (X103, X106, X109) USB 3.0 Ports

Pin	Signal Name	Pin	Signal Name	9-pin USB Connector Type A Version 3.0/2.0
USB 2.0 contact pins		USB 3.0 contact pins		
1	VCC, fused (900 mA max.)	5	StdA_SSRX-	
2	Data-	6	StdA_SSRX+	
3	Data+	7	GND_DRAIN	
4	GND	8	StdA_SSTX-	
		9	StdA_SSTX+	

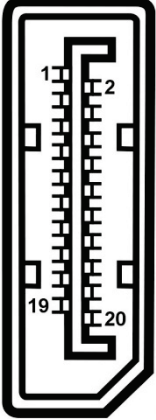
14.1.4. (X104, X107, X110) USB 2.0 Ports

Table 60: (X104, X107, X110) USB 2.0 Ports

Pin	Signal Name	4-pin USB Connector Typ A Version 2.0
1	VCC	
2	Data-	
3	Data+	
4	GND	

14.1.5. (X112, X113, X203) DisplayPorts

Table 61: (X112, X113, X203) DisplayPorts

Pin	Signal Name	DisplayPort	Signal Name	Pin
1	ML Lane 0 (p)		GND (ML Lane 0)	2
3	ML Lane 0 (n)		Lane 1 (p)	4
5	GND (ML Lane 1)		Lane 1 (n)	6
7	Lane 2 (p)		GND (ML Lane 2)	8
9	Lane 2 (n)		Lane 3 (p)	10
11	GND (ML Lane 3)		Lane 3 (n)	12
13	AUX SEL#		Pull-down to GND	14
15	AUX CH (p)		GND (AUX CH)	16
17	AUX CH (n)		Hot Plug	18
19	GND (GND_DDC)		3.3V (DDC EEPROM power) 500 mA fused	20

14.1.6. (X114) Serial Interface COM 1 (RS232, RS422, RS485)

The mode can be selected in the BIOS

Table 62: (X114) Serial Interface COM 1, configured as RS232)

Pin	Signal Name	9-pin D-SUB Connector (male)
1	DCD (Data Carrier Detect)	
2	RXD (Receive Data)	
3	TXD (Transmit Data)	
4	DTR (Data Terminal Ready)	
5	GND (Signal Ground)	
6	DSR (Data Set Ready)	
7	RTS (Request to Send)	
8	CTS (Clear to Send)	
9	RI (Ring Indicator)	

Table 63: (X114) Serial Interface COM 1, configured as single RS485

Pin	Signal Name	9-pin D-SUB Connector (male)
1	TxD/RxD- (Data -)	
2	TxD/RxD+ (Data+)	
3		
4		
5	GND (Signal Ground)	
6		
7		
8		
9		

Table 64: (X114) Serial Interface COM 1, configured as single RS422

Pin	Signal Name	9-pin D-SUB Connector (male)
1	TxD- (Transmit Data-)	
2	TxD+ (Transmit Data+)	
3	RxD+ (Receive Data+)	
4	RxD- (Receive Data-)	
5	GND (Signal Ground)	
6		
7		
8		
9		

Table 65: (X114) Serial Interface COM 1 and COM2, configured as dual RS485

Pin	Signal Name	9-pin D-SUB Connector (male)
1	TxD/RxD- (COM1 Data -)	
2	TxD/RxD+ (COM1 Data+)	
3		
4		
5	GND (Signal Ground)	
6	TxD/RxD- (COM2 Data -)	
7	TxD/RxD+ (COM2 Data+)	
8		
9		

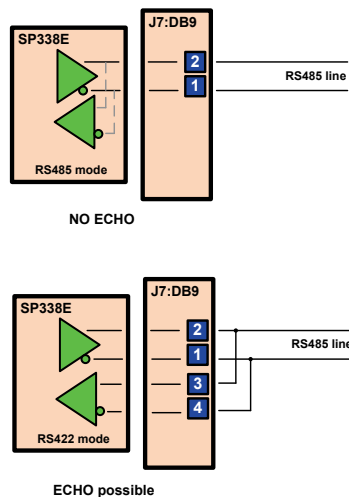
Table66: (X114) Serial Interface COM 1 and COM2, configured as dual RS422

Pin	Signal Name	9-pin D-SUB Connector (male)
1	TxD- (COM1 Transmit Data-)	
2	TxD+ (COM1 Transmit Data+)	
3	RxD+ (COM1 Receive Data+)	
4	RxD- (COM1 Receive Data-)	
5	GND (Signal Ground)	
6	TxD- (COM2 Transmit Data-)	
7	TxD+ (COM2 Transmit Data+)	
8	RxD+ (COM2 Receive Data+)	
9	RxD- (COM2 Receive Data-)	



If RS485 is needed in Echo mode, the RS422 mode must be selected and the lines must be connected according below picture.
 If dual (RS422/RS485) mode is selected the second serial Port connector X205 is not usable.

Figure 96: RS485 Echo mode configuration



14.2. Optional Interfaces via Adapter Modules

14.2.1. (X201) 2nd Power Input Connector

For pin assignment, refer to 14.1.1.

14.2.2. (X 202) WideLink



This port must be factory installed and configured only.
 Your KBox C-103 can either be equipped with a 3rd DisplayPort or a WideLink port.
 Only one of these two interfaces (WideLink and DP 3) can be ordered as optional extension of your KBox C-103 system.

Table 67: (X201) WideLink

Pin #	Signal Name	WideLink (RJ45 female)
1	TRD1+	
2	TRD1-	
3	TRD2+	
4	TRD3+	
5	TRD3-	
6	TRD2-	
7	TRD4+	
8	TRD4-	

Green LED	Yellow LED
Link LED	HDMI Activity LED

14.2.3. (X 203) 3rd DisplayPort

For pin assignment, refer to 14.1.5.



This port must be factory installed and configured only.
 Your KBox C-103 can either be equipped with a 3rd DisplayPort or a WideLink port.
 Only one of these two interfaces (WideLink and DP 3) can be ordered as optional extension of your KBox C-103 system.

14.2.4. (X 205) Serial Port RS232/RS422



This port must be factory installed and configured only.

When you order the KBox C-103 with this extended interface via RS232/422 adapter module, you have to specify in your ordering:

- ▶ the needed configuration of this port as RS232 or RS422 and
- ▶ for RS422 configuration: if the onboard termination resistor (120Ω) should be enabled or disabled.

14.2.4.1. Serial Port RS232/RS422 configured as RS232

Table 68: Serial Port RS232/RS422 configured as RS232

Pin	Signal Name	9-pin D-SUB Connector (male)
1	DCD (Data Carrier Detect)	
2	RXD (Receive Data)	
3	TXD (Transmit Data)	
4	DTR (Data Terminal Ready)	
5	GND (Signal Ground)	
6	DSR (Data Set Ready)	
7	RTS (Request to Send)	
8	CTS (Clear to Send)	
9	RI (Ring Indicator)	

14.2.4.2. Serial Port RS232/RS422 configured as RS422

Table 69: Serial Port RS232/RS422 configured as RS422

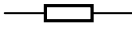
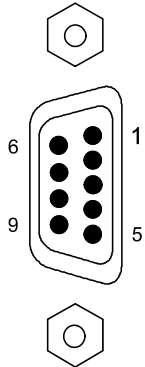
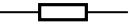
Pin	Signal Name	9-pin D-SUB Connector (male)
1	Do not connect	
2	RxD- (Receive Data-)	
3	TxD+ (Transmit Data+)	
4	Do not connect	
5	GND (Signal Ground)	
6	Do not connect	
7	TxD- (Transmit Data-)	
8	RxD+ (Receive Data+)	
9	Do not connect	

14.2.5. (X 204) CAN Bus Port



If a termination resistor (120Ω) is required, you have to make a connection (bridge) between pin 1 and 2, respectively pin 7 and 8, in order to enable the onboard termination resistor (120Ω).

Table 70: (X204) CAN Bus Port

Pin	Signal Name		9-pin D-SUB Connector (male)
1	TERM L	120Ω 	
	2	CAN_L CAN_L bus line (dominant low)	
3	CAN_GND (CAN Ground) Reference potential		
4	NC (not connected)		
5	NC (not connected)		
6	NC (not connected)		
7	CAN_H	CAN_H bus line (dominant high)	
	8	TERM H 120Ω 	
9	NC (not connected)		



About Kontron – Member of the S&T Group

Kontron is a global leader in IoT/Embedded Computing Technology (ECT). As a part of technology group S&T, Kontron, together with its sister company S&T Technologies, offers a combined portfolio of secure hardware, middleware and services for Internet of Things (IoT) and Industry 4.0 applications. With its standard products and tailor-made solutions based on highly reliable state-of-the-art embedded technologies, Kontron provides secure and innovative applications for a variety of industries. As a result, customers benefit from accelerated time-to-market, reduced total cost of ownership, product longevity and the best fully integrated applications overall.

For more information, please visit: www.kontron.com



GLOBAL HEADQUARTERS

Kontron Europe GmbH

Gutenbergstraße 2
85737 Ismaning, Germany
Tel.: + 49 821 4086-0
Fax: + 49 821 4086-111
info@kontron.com