



▶ KBOX C-103-NGSF - USER GUIDE

This page has been intentionally left blank

## Disclaimer

Kontron would like to point out that the information contained in this user guide may be subject to alteration, particularly as a result of the constant upgrading of Kontron products. This document does not entail any guarantee on the part of Kontron with respect to technical processes described in the user guide or any product characteristics set out in the user guide. Kontron assumes no responsibility or liability for the use of the described product(s), conveys no license or title under any patent, copyright or mask work rights to these products and makes no representations or warranties that these products are free from patent, copyright or mask work right infringement unless otherwise specified. Applications that are described in this user guide are for illustration purposes only. Kontron makes no representation or warranty that such application will be suitable for the specified use without further testing or modification. Kontron expressly informs the user that this user guide only contains a general description of processes and instructions which may not be applicable in every individual case. In cases of doubt, please contact Kontron.

This user guide is protected by copyright. All rights are reserved by Kontron. No part of this document may be reproduced, transmitted, transcribed, stored in a retrieval system, or translated into any language or computer language, in any form or by any means (electronic, mechanical, photocopying, recording, or otherwise), without the express written permission of Kontron. Kontron points out that the information contained in this user guide is constantly being updated in line with the technical alterations and improvements made by Kontron to the products and thus this user guide only reflects the technical status of the products by Kontron at the time of publishing.

Brand and product names are trademarks or registered trademarks of their respective owners.

©2021 by Kontron Europe GmbH

Kontron Europe GmbH

Gutenbergstraße 2  
85737 Ismaning  
Germany  
[www.kontron.com](http://www.kontron.com)

## High Risk Applications Hazard Notice

THIS DEVICE AND ASSOCIATED SOFTWARE ARE NOT DESIGNED, MANUFACTURED OR INTENDED FOR USE OR RESALE FOR THE OPERATION OF NUCLEAR FACILITIES, THE NAVIGATION, CONTROL OR COMMUNICATION SYSTEMS FOR AIRCRAFT OR OTHER TRANSPORTATION, AIR TRAFFIC CONTROL, LIFE SUPPORT OR LIFE SUSTAINING APPLICATIONS, WEAPONS SYSTEMS, OR ANY OTHER APPLICATION IN A HAZARDOUS ENVIRONMENT, OR REQUIRING FAIL-SAFE PERFORMANCE, OR IN WHICH THE FAILURE OF PRODUCTS COULD LEAD DIRECTLY TO DEATH, PERSONAL INJURY, OR SEVERE PHYSICAL OR ENVIRONMENTAL DAMAGE (COLLECTIVELY, "HIGH RISK APPLICATIONS").

You understand and agree that your use of Kontron devices as a component in High Risk Applications is entirely at your risk. To minimize the risks associated with your products and applications, you should provide adequate design and operating safeguards. You are solely responsible for compliance with all legal, regulatory, safety, and security related requirements concerning your products. You are responsible to ensure that your systems (and any Kontron hardware or software components incorporated in your systems) meet all applicable requirements. Unless otherwise stated in the product documentation, the Kontron device is not provided with error-tolerance capabilities and cannot therefore be deemed as being engineered, manufactured or setup to be compliant for implementation or for resale as device in High Risk Applications. All application and safety related information in this document (including application descriptions, suggested safety measures, suggested Kontron products, and other materials) is provided for reference only.

---

**CAUTION**

Handling and operation of the product is permitted only for trained personnel within a work place that is access controlled. Please follow the "General Safety Instructions" supplied with the system.

---

**NOTICE**

You find the most recent version of the "General Safety Instructions" online in the download area of this product.

---

## Revision History

Revision	Brief Description of Changes	Date of Issue	Author /Editor
PRE	Initial Issue	2021-May	RP

## Terms and Conditions

Kontron warrants products in accordance with defined regional warranty periods. For more information about warranty compliance and conformity, and the warranty period in your region, visit <http://www.kontron.com/terms-and-conditions>.

Kontron sells products worldwide and declares regional General Terms & Conditions of Sale, and Purchase Order Terms & Conditions. Visit <http://www.kontron.com/terms-and-conditions>.

For contact information, refer to the corporate offices contact information on the last page of this user guide or visit our website [CONTACT US](#).

## Customer Support

Find Kontron contacts by visiting: <https://www.kontron.de/support-and-services>.







## Customer Service

As a trusted technology innovator and global solutions provider, Kontron extends its embedded market strengths into a services portfolio allowing companies to break the barriers of traditional product lifecycles. Proven product expertise coupled with collaborative and highly-experienced support enables Kontron to provide exceptional peace of mind to build and maintain successful products.

For more details on Kontron's service offerings such as: enhanced repair services, extended warranty, Kontron training academy, and more visit <https://www.kontron.de/support-and-services>.

## Symbols

The following symbols may be used in this user guide

<b>▲ DANGER</b>	DANGER indicates a hazardous situation which, if not avoided, will result in death or serious injury.
<b>▲ WARNING</b>	WARNING indicates a hazardous situation which, if not avoided, could result in death or serious injury.
<b>NOTICE</b>	NOTICE indicates a property damage message.
<b>▲ CAUTION</b>	CAUTION indicates a hazardous situation which, if not avoided, may result in minor or moderate injury.
	<p><b>Electric Shock!</b></p> <p>This symbol and title warn of hazards due to electrical shocks (&gt; 60 V) when touching products or parts of products. Failure to observe the precautions indicated and/or prescribed by the law may endanger your life/health and/or result in damage to your material.</p>
	<p><b>ESD Sensitive Device!</b></p> <p>This symbol and title inform that the electronic boards and their components are sensitive to static electricity. Care must therefore be taken during all handling operations and inspections of this product in order to ensure product integrity at all times.</p>
	<p><b>HOT Surface!</b></p> <p>Do NOT touch! Allow to cool before servicing.</p>
	<p><b>Laser!</b></p> <p>This symbol inform of the risk of exposure to laser beam and light emitting devices (LEDs) from an electrical device. Eye protection per manufacturer notice shall review before servicing.</p>
	<p>This symbol indicates general information about the product and the user guide.</p> <p>This symbol also indicates detail information about the specific product configuration.</p>
	<p>This symbol precedes helpful hints and tips for daily use.</p>



## For Your Safety

Your new Kontron product was developed and tested carefully to provide all features necessary to ensure its compliance with electrical safety requirements. It was also designed for a long fault-free life. However, the life expectancy of your product can be drastically reduced by improper treatment during unpacking and installation. Therefore, in the interest of your own safety and of the correct operation of your new Kontron product, you are requested to conform with the following guidelines.

### High Voltage Safety Instructions

As a precaution and in case of danger, the power connector must be easily accessible. The power connector is the product's main disconnect device.

#### ⚠ CAUTION

##### Warning

All operations on this product must be carried out by sufficiently skilled personnel only.

#### ⚠ CAUTION



##### Electric Shock!

Before installing a non hot-swappable Kontron product into a system always ensure that your mains power is switched off. This also applies to the installation of piggybacks. Serious electrical shock hazards can exist during all installation, repair, and maintenance operations on this product. Therefore, always unplug the power cable and any other cables which provide external voltages before performing any work on this product.

Earth ground connection to vehicle's chassis or a central grounding point shall remain connected. The earth ground cable shall be the last cable to be disconnected or the first cable to be connected when performing installation or removal procedures on this product.

### Special Handling and Unpacking Instruction

#### NOTICE



##### ESD Sensitive Device!

Electronic boards and their components are sensitive to static electricity. Therefore, care must be taken during all handling operations and inspections of this product, in order to ensure product integrity at all times.

Do not handle this product out of its protective enclosure while it is not used for operational purposes unless it is otherwise protected.

Whenever possible, unpack or pack this product only at EOS/ESD safe work stations. Where a safe work station is not guaranteed, it is important for the user to be electrically discharged before touching the product with his/her hands or tools. This is most easily done by touching a metal part of your system housing.

It is particularly important to observe standard anti-static precautions when changing piggybacks, ROM devices, jumper settings etc. If the product contains batteries for RTC or memory backup, ensure that the product is not placed on conductive surfaces, including anti-static plastics or sponges. They can cause short circuits and damage the batteries or conductive circuits on the product.



## Lithium Battery Precautions

If your product is equipped with a lithium battery, take the following precautions when replacing the battery.

### ▲ CAUTION

---

Danger of explosion if the battery is replaced incorrectly.

- ▶ *Replace only with same or equivalent battery type recommended by the manufacturer.*
  - ▶ *Dispose of used batteries according to the manufacturer's instructions.*
- 

## General Instructions on Usage

In order to maintain Kontron's product warranty, this product must not be altered or modified in any way. Changes or modifications to the product, that are not explicitly approved by Kontron and described in this user guide or received from Kontron Support as a special handling instruction, will void your warranty.

This product should only be installed in or connected to systems that fulfill all necessary technical and specific environmental requirements. This also applies to the operational temperature range of the specific board version that must not be exceeded. If batteries are present, their temperature restrictions must be taken into account.

In performing all necessary installation and application operations, only follow the instructions supplied by the present user guide.

Keep all the original packaging material for future storage or warranty shipments. If it is necessary to store or ship the product then re-pack it in the same manner as it was delivered.

Special care is necessary when handling or unpacking the product. See Special Handling and Unpacking Instruction.

## Quality and Environmental Management

Kontron aims to deliver reliable high-end products designed and built for quality, and aims to complying with environmental laws, regulations, and other environmentally oriented requirements. For more information regarding Kontron's quality and environmental responsibilities, visit <http://www.kontron.com/about-kontron/corporate-responsibility/quality-management>.

## Disposal and Recycling

Kontron's products are manufactured to satisfy environmental protection requirements where possible. Many of the components used are capable of being recycled. Final disposal of this product after its service life must be accomplished in accordance with applicable country, state, or local laws or regulations.

## WEEE Compliance

The Waste Electrical and Electronic Equipment (WEEE) Directive aims to:

- ▶ *Reduce waste arising from electrical and electronic equipment (EEE)*
- ▶ *Make producers of EEE responsible for the environmental impact of their products, especially when the product become waste*
- ▶ *Encourage separate collection and subsequent treatment, reuse, recovery, recycling and sound environmental disposal of EEE*
- ▶ *Improve the environmental performance of all those involved during the lifecycle of EEE*



Environmental protection is a high priority with Kontron.  
Kontron follows the WEEE directive  
You are encouraged to return our products for proper disposal.

---

## Table of Contents

Symbols .....	6
For Your Safety .....	8
High Voltage Safety Instructions .....	8
Lithium Battery Precautions .....	9
General Instructions on Usage .....	9
Quality and Environmental Management .....	9
Disposal and Recycling .....	9
WEEE Compliance .....	9
Table of Contents .....	11
List of Tables .....	14
List of Figures .....	14
1/ General Safety Instructions .....	16
1.1. Electrostatic Discharge (ESD) .....	19
1.1.1. Grounding Methods .....	19
1.2. Instructions for the optional Lithium Battery .....	19
2/ Shipment and Unpacking .....	20
2.1. Unpacking .....	20
2.2. Scope of Delivery .....	20
2.2.1. Optional Parts (System Expansion) .....	20
2.2.2. Optional System Extension .....	20
2.3. Type Label and Product Identification .....	20
3/ System Overview .....	22
3.1. Optional RTC Lithium Battery (internally-accessible) .....	23
3.2. System Expansion Capabilities .....	23
3.2.1. M.2 Interfaces .....	23
3.2.2. Mini PCI Express® Interface .....	23
3.2.3. Standard PCI Express® Interfaces .....	23
3.2.4. SATA Interfaces .....	23
3.2.5. Internal USB 3.0 Interface .....	24
3.2.6. Internal microSD Card and microSIM Card Interface .....	24
3.3. KBox C-103-NGSF Variant .....	26
3.3.1. X101/X201 - Power Input Connectors .....	28
3.3.2. X102/X105/X108/X111 - Ethernet Connectors (ETH) .....	29
3.3.3. X103/X106/X109 - USB 3.0 .....	29
3.3.4. X104/X107/X110 - USB 2.0 .....	29
3.3.5. X112/X113/X203 - DisplayPorts .....	30
3.3.6. X114 - RS232 Port .....	30
3.3.7. POWER Button and PWR LED .....	30
3.3.8. RESCUE Button and RSQ LED .....	31
3.3.9. Status and General Purpose LEDs .....	31
3.3.10. PCI/PCIe Expansion Slots .....	32
3.3.11. Internal or Removable 2.5" SATA HDDs/SSDs .....	33
3.3.11.1. Installing/Removing the removable HDD/SSD .....	34
3.4. Left and Right Side View .....	35
3.5. Top and Bottom Side View .....	35
3.6. Rear Side View .....	36
3.7. Functional Earth Stud .....	36
4/ System Extensions .....	38
4.1. (X203) - 3 <sup>rd</sup> DisplayPort .....	38

4.2. (X206) WiFi .....	38
4.2.1. WiFi/BT .....	38
4.3. Optional Versions with Fan Tray - KBox C-103-NGSF .....	39
5/ Accessing Internal Components .....	40
5.1. Top Cover .....	41
5.2. Opening and Closing the KBox C-103-NGSF .....	43
5.2.1. DIP Switch .....	46
5.2.2. Expansion Socket for PCIe Mini Cards .....	46
5.2.3. Riser Cards Expansion Sockets for PCI/PCIe Cards .....	46
5.2.4. Installing/Removing an M.2 Module .....	47
5.2.5. Installing/Removing a microSD/microSIM Card .....	48
6/ Power and Thermal Considerations .....	49
6.1. System Power Portfolio .....	49
6.2. Convection Cooling .....	49
6.3. Active Cooling via the optional Fan Tray .....	49
6.4. Minimum System Clearance .....	51
6.5. Third Party Components .....	51
6.6. Processor Thermal Monitoring .....	51
6.7. Processor Thermal Trip Feature .....	51
7/ Installation Instructions .....	52
7.1. Specifications of the internal M.2 Connectors .....	54
7.2. Control Cabinet Mounting .....	54
7.3. DC Power Plug Terminal .....	56
7.3.1. Cabling .....	56
7.4. Side Wall Mounting (Option) .....	57
8/ Starting Up .....	58
8.1. Connecting to DC Main Power Supply .....	58
8.2. Power OFF/ON Procedure .....	59
8.3. Operating System and Hardware Component Drivers .....	59
9/ Maintenance and Cleaning .....	60
9.1. Replacing the Lithium Battery .....	60
9.2. Preventive Maintenance for SSD Drives .....	61
9.3. Replacing the Fan Tray .....	61
9.4. Cleaning the Air Filter .....	63
10/ uEFI BIOS .....	66
10.1. Starting the uEFI BIOS .....	66
10.2. Setup Menus .....	68
10.2.1. Main Setup Menu .....	68
10.2.2. Advanced Setup Menu .....	69
10.2.3. Chipset Setup Menu .....	69
10.2.4. Security Setup Menu .....	69
10.2.4.1. Remember the Password .....	69
10.2.5. Boot Setup Menu .....	70
10.2.6. Save and Exit Setup Menu .....	70
10.3. The uEFI Shell .....	70
10.3.1. Basic Operation of the uEFI Shell .....	70
10.3.1.1. Entering the uEFI Shell .....	71
10.3.1.2. Exiting the uEFI Shell .....	71
10.4. uEFI Shell Scripting .....	72
10.4.1. Startup Scripting .....	72
10.4.2. Create a Startup Script .....	72

10.4.3. Examples of Startup Scripts ..... 72

10.4.3.1. Execute Shell Script on Other Harddrive ..... 72

10.5. Updating the uEFI BIOS ..... 73

10.5.1. Updating Procedure ..... 73

10.5.2. uEFI BIOS Recovery ..... 73

11/ Technical Specifications ..... 74

11.1.1. Mechanical Specifications of the KBox C-103-NGSF ..... 75

11.1.2. Mechanical Specifications of the KBox C-103-NGSF with Fan Tray Option ..... 76

11.2. Environmental Specifications ..... 79

11.3. Standards, Certifications and Directives Compliance ..... 79

11.4. Power Supply Specification ..... 80

11.4.1. Power Supply Protection Requirements ..... 80

11.4.2. Power Consumption ..... 82

11.4.3. Protective Earth Stud Bolt ..... 82

12/ Standard Interfaces - Pin Assignments ..... 83

12.1.1. (X101) Power Input Connector ..... 83

12.1.2. (X102, X105, X108, X111) Ethernet Connectors ..... 83

12.1.3. (X103, X106, X109) USB 3.0 Ports ..... 84

12.1.4. (X104, X107, X110) USB 2.0 Ports ..... 84

12.1.5. (X112, X113, X203) DisplayPorts ..... 84

12.1.6. (X114) Serial Interface COM 1 (RS232, RS422, RS485) ..... 85

12.2. Optional Interfaces via Adapter Modules ..... 87

12.2.1. (X201) 2<sup>nd</sup> Power Input Connector ..... 87

12.2.2. (X 203) 3<sup>rd</sup> DisplayPort ..... 87

12.2.3. (X 205) Serial Port RS232/RS422 ..... 88

12.2.3.1. Serial Port RS232/RS422 configured as RS232 ..... 88

12.2.3.2. Serial Port RS232/RS422 configured as RS422 ..... 88

Appendix A: List of Acronyms ..... 89

About Kontron - Member of the S&T Group ..... 90

## List of Tables

Table 2: Product Identification Table .....	21
Table 4: Status and General Purpose LEDs .....	31
Table 6: WiFi/BT Expansion Card Option .....	38
Table 13: Power Consumption .....	49
Table 14: Current and voltage provided in the KBOX C-103-NGSF per port .....	49
Table 15: Maximum Power supplied on the PCIe Slot .....	49
Table 19: Specifications of the internal M.2 Connectors .....	54
Table 20: Navigation Hot Keys Available in the Legend Bar .....	66
Table 21: Main Setup Menu Sub-screens and Functions .....	68
Table 26: Security Setup Menu Functions .....	69
Table 28: Save and Exit Setup Menu Functions .....	70
Table 47: Technical Specifications .....	74
Table 49: Mechanical Specifications of the KBox C-103-NGSF .....	78
Table 52: Environmental Specifications .....	79
Table 56: KBox C-103-x Electrical Specification .....	80
Table 57: (X101) Power Input Connector .....	83
Table 58: (X102, X105, X108, X111) Ethernet Connectors .....	83
Table 59: (X103, X106, X109) USB 3.0 Ports .....	84
Table 60: (X104, X107, X110) USB 2.0 Ports .....	84
Table 61: (X112, X113, X203) DisplayPorts .....	84
Table 62: (X114) Serial Interface COM 1, configured as RS232) .....	85
Table 63: (X114) Serial Interface COM 1, configured as single RS485 .....	85
Table 64: (X114) Serial Interface COM 1, configured as single RS422 .....	85
Table 65: (X114) Serial Interface COM 1 and COM2, configured as dual RS485 .....	85
Table 66: (X114) Serial Interface COM 1 and COM2, configured as dual RS422 .....	86
Table 68: Serial Port RS232/RS422 configured as RS232 .....	88
Table 69: Serial Port RS232/RS422 configured as RS422 .....	88
Table 71: List of Acronyms (Example) .....	89

## List of Figures

Figure 1: Example of KBox C-103-NGSF type label .....	21
Figure 4: Bottom side view .....	25
Figure 5: Right side view .....	25
Figure 6: Front side view config. with removable drives .....	25
Figure 7: Front side view config. without removable drives .....	25
Figure 8: Left side view .....	25
Figure 9: Top side view .....	25
Figure 10: Rear side view .....	25
Figure 11: KBox C-103-NGSF - front view (shown with removable drive bays and without mounting brackets) .....	26
Figure 12: Block Diagram - KBox C-103-NGSF .....	27
Figure 14: X101 - 24VDC power input connector .....	29
Figure 12: Detail - Power button and PWR LED/Rescue button and RSQ LED .....	30
Figure 16: Detail - Status and General Purpose LEDs .....	31
Figure 14: Drive 1 and Drive 2 for removable 2.5" SATA HDD/SSD (option); closed drive bays .....	33
Figure 15: Drive bay 1 with opened drive bay cover .....	33
Figure 16: Inserting/removing a 2.5" removable SSD .....	33
Figure 17: Right side of the KBox C-103-NGSF system .....	35
Figure 18: Left side of the KBox C-103-NGSF system .....	35
Figure 19: Top side of the KBox C-103-NGSF system .....	35
Figure 20: Bottom side of the KBox C-103-NGSF system .....	35
Figure 21: Rear side of the KBox C-103-NGSF system .....	36
Figure 22: KBox C-103-NGSF-1 equipped with the optional fan tray .....	39
Figure 34: Inside of the top cover with centering and fixing brackets .....	41

Figure 24: Removing the centering and fixing bracket of the top cover (detail of the KBox C-103-NGSF) ..... 43

Figure 36: Removing the cover (detail of the KBox C-103-NGSF) ..... 43

Figure 37: KBox C-103-NGSF - removing the right side cover ..... 44

Figure 38: KBox C-103-NGSF without top and right side cover (shown with a PCIe riser card) ..... 44

Figure 28: microSD/microSIM combo connector ..... 48

Figure 48: Keep out area for mounting around KBox C-103-NGSF (front side view without fan tray) ..... 55

Figure 49: Keep out area for mounting around KBox C-103-NGSF (front side view with optional fan tray) ..... 55

Figure 53: Phoenix power plug terminal ..... 56

Figure 32: KBox C-103-NGSF with fan tray and side wall mounting brackets ..... 57

Figure 55: Location of the optional Lithium battery ..... 60

Figure 56: Lithium battery polarity ..... 60

Figure 57: Fan tray extension (detail: shown as KBox C-103-NGSF) ..... 63

Figure 58: KBox C-103-NGSF with removed fan tray and removed air filter ..... 64

Figure 59: Filter mat Holder without air filter ..... 64

Figure 60: Holder (shown for KBox C-103-NGSF) with air filter ..... 64

Figure 61: Air filter (shown for KBox C-103-NGSF) ..... 64

Figure 76: Dimensions: right side (KBox C-103-NGSF) ..... 75

Figure 77: Dimensions: front side with key holes (KBox C-103-NGSF) ..... 75

Figure 78: Dimensions: detail key hole (KBox C-103-NGSF) ..... 75

Figure 79: Dimensions: top side (KBox C-103-NGSF) ..... 75

Figure 80: Dimensions: right side (KBox C-103-NGSF with fan tray option) ..... 76

Figure 81: Dimensions: front side with key holes (KBox C-103-NGSF with fan tray option) ..... 76

Figure 82: Dimensions: detail key hole (KBox C-103-NGSF with fan tray option) ..... 76

Figure 83: Dimensions: top side (KBox C-103-NGSF with fan tray option) ..... 76

Figure 96: RS485 Echo mode configuration ..... 86

## 1/ General Safety Instructions

### **⚠ WARNING**



Please read this chapter carefully and take careful note of the instructions, which have been compiled for your safety and to ensure to apply in accordance with intended regulations. If the following general safety instructions are not observed, it could lead to injuries to the operator and/or damage of the product; in cases of nonobservance of the instructions Kontron is exempt from accident liability, this also applies during the warranty period.

The product has been built and tested according to the basic safety requirements for low voltage (LVD) applications and has left the manufacturer in safety-related, flawless condition. To maintain this condition and also to ensure safe operation, the operator must not only observe the correct operating conditions for the product but also the following general safety instructions:

- ▶ *The product must be used as specified in the product documentation, in which the instructions for safety for the product and for the operator are described. These contain guidelines for setting up, installation and assembly, maintenance, transport or storage.*
  - ▶ *The on-site electrical installation must meet the requirements of the country's specific local regulations.*
  - ▶ *The product must be connected only to a certified mains power supply complying with the requirements of IEC 60950-1 or IEC 62368-1 standard or better.*
  - ▶ *If a power supply comes with the product, only this power supply should be used to supply the product.*
  - ▶ *If a power cable for your region comes with the product, only this cable should be used to supply the product.*
  - ▶ *Do not use an extension cable to connect the product.*
  - ▶ *To guarantee that sufficient air circulation is available to cool the product, please ensure that the ventilation openings are not covered or blocked. If an air filter is provided, this should be cleaned regularly. Do not place the system close to heat sources or damp places. Make sure the system is well ventilated.*
  - ▶ *Only devices or parts that fulfill the safety requirements as stipulated by the applied safety standards may be connected to the available interfaces.*
  - ▶ *Before opening the device, make sure that the device is disconnected from the mains.*
  - ▶ *Switching off the device by its power button does not disconnect it from the mains. Complete disconnection is only possible if the power cable is removed from the wall plug or from the device. Ensure that there is free and easy access to enable disconnection.*
  - ▶ *The device may only be opened for the insertion or removal of add-on cards (depending on the configuration of the system). This may only be carried out by qualified operators.*
  - ▶ *If extensions are being carried out, the following must be observed:*
    - ▶ *All effective legal regulations and all technical data are adhered to.*
    - ▶ *The power consumption of any add-on card does not exceed the specified limitations.*
    - ▶ *The current consumption of the system does not exceed the value stated on the product label.*
  - ▶ *Only original accessories that have been approved by Kontron can be used.*
  - ▶ *Please note: safe operation is no longer possible when any of the following applies:*
    - ▶ *The device has visible damages.*
    - ▶ *The device is no longer functioning.*
- In this case the device must be switched off and it must be ensured that the device can no longer be operated.





**Additional safety instructions for DC power supply circuits**

- ▶ *To guarantee safe operation of devices with DC power supply voltages larger than 60 volts DC or a power consumption larger than 240 VA, please observe that:*
  - ▶ no cables or parts without insulation in electrical circuits with dangerous voltage or power should be touched directly or indirectly
  - ▶ a reliable protective earthing connection is provided
  - ▶ a suitable, easily accessible disconnecting device is used in the application (e.g. overcurrent protective device), if the device itself is not disconnectable
  - ▶ a disconnect device, if provided in or as part of the equipment, shall disconnect both poles simultaneously
  - ▶ interconnecting power circuits of different devices cause no electrical hazards
- ▶ *A sufficient dimensioning of the power cable wires must be selected - according to the maximum electrical specifications on the product label - as stipulated by the applied safety standards.*
- ▶ *The product does not generally fulfill the requirements for "centralized DC power systems" as stipulated by the applied safety standards and therefore may not be connected to such devices!*

## 1.1. Electrostatic Discharge (ESD)




---

A sudden discharge of electrostatic electricity can destroy static-sensitive devices or micro-circuitry.

---

Therefore proper packaging and grounding techniques are necessary precautions to prevent damage. Always take the following precautions:

1. Transport boards in ESD-safe containers such as boxes or bags.
2. Keep electrostatic sensitive parts in their containers until they arrive at the ESD-safe workplace.
3. Always be properly grounded when touching a sensitive board, component, or assembly.
4. Store electrostatic-sensitive boards in protective packaging or on antistatic mats.

### 1.1.1. Grounding Methods

By adhering to the guidelines below, electrostatic damage to the device can be avoided:

1. Cover workstations with approved antistatic material. Always wear a wrist strap connected to workplace. Always use properly grounded tools and equipment.
2. Use antistatic mats, heel straps, or air ionizers for more protection.
3. Always handle electrostatically sensitive components by their edge or by their casing.
4. Avoid contact with pins, leads, or circuitry.
5. Turn off power and input signals before inserting and removing connectors or connecting test equipment.
6. Keep work area free of non-conductive materials such as ordinary plastic assembly aids and Styrofoam.
7. Use only field service tools which are conductive, such as cutters, screwdrivers, and vacuum cleaners.
8. Always place drives and boards PCB-assembly-side down on the foam.

## 1.2. Instructions for the optional Lithium Battery

If ordered, your KBox C-103-NGSF is equipped with an optional lithium battery. For the replacement of this battery please observe the instructions described in section 0 "Optional RTC Lithium Battery (internally-accessible)".

### **⚠ WARNING**

---

Danger of explosion when replacing with wrong type of battery. Replace only with the same or equivalent type recommended by the manufacturer. The lithium battery type must be UL recognized.

---




---

Do not dispose of lithium batteries in general trash collection. Dispose of the battery according to the local regulations dealing with the disposal of these special materials, (e.g. to the collecting points for dispose of batteries).

---

## 2/ Shipment and Unpacking

### 2.1. Unpacking

Proceed as follows to unpack the unit:

1. Remove packaging.
2. Do not discard the original packaging. Keep it for future relocation.
3. Check the delivery for completeness by comparing it with your order.
4. Please keep the associated paperwork. It contains important information for handling the unit.
5. Check the contents for visible shipping damage.
6. If you notice any shipping damage or inconsistencies between the contents and your order, please contact Kontron for help and information.

### 2.2. Scope of Delivery

- ▶ KBox C-103-NGSF (Build as Proof of Concept)
- ▶ POWER-SUBCON PSC 1,5/ 3-F, 3-pin plug
- ▶ Device Passport which states the status of the delivered System

#### 2.2.1. Optional Parts (System Expansion)

- ▶ Front accessible drive bays for 2.5" SATA HDD/SSDs
- ▶ M.2 cards
- ▶ PCIe cards
- ▶ USB Dongles

#### 2.2.2. Optional System Extension

- ▶ Optional internally accessible RTC lithium battery
- ▶ Optional fan tray
- ▶ GSM (LTE) Support: via internal factory mounted adapter module
- ▶ WiFi support: via internal factory mounted adapter module

### 2.3. Type Label and Product Identification

The type label (product name, serial number, part number, production date) of your KBox C-103-NGSF system is located on the right side of the device (refer to

Figure 1 and Figure 17, pos. 9).

Figure 1: Example of KBox C-103-NGSF type label



Table 1: Product Identification Table

System Type	Product Designation	Product Identifikation
KBox C	KBox C-103-NGSF	KBox C-103-NGSF: corresponds for system configurations with two slot rows for optional removable DRIVES and/or PCIe expansion slot

## 3/ System Overview

The KBox C-103-NGSF offers a maintenance free (wartungsfrei) operation. That means it operates without battery, fans and rotating media (HDD).

### Standard Front Panel:

The following interfaces are available with the KBox C-103-NGSF:

Some of which are non-functional because the BIOS or the hardware is not supporting the feature.

These non-functional-features are marked in *italics*

- ▶ 24VDC input power (X101, optional 2<sup>nd</sup> power input X201)
- ▶ 1x 2.5 Gigabit Ethernet (X111)
- ▶ 3x Gigabit Ethernet (X102, X105, X108)
- ▶ 3x USB 3.0 (X103, X106, X109)
- ▶ 3x USB 2.0 (X104, X107, X110)
- ▶ 2x DisplayPort (X112, X113)
- ▶ *RS232/422/485 serial port (X114)*
- ▶ Buttons with corresponding LEDs:
  - ▶ *RSQ (Rescue)*
  - ▶ *PWR (Power)*
- ▶ *LEDs: (only show Post code, BIOS related)*
  - ▶ *GP1 to GP4 (general purpose LEDs)*
  - ▶ *THERM (thermal status)*
  - ▶ *DRIVE (SSD/HDD drive status)*
  - ▶ *M2 (M.2 card activity)*
  - ▶ *WD (Watchdog status)*

### Standard Baseboard - Onboard and System Expansion Capabilities:

- ▶ up to 2x SATA and power connector (for internal or removable devices, depending on the configuration)
- ▶ 1x Mini PCIe x1 socket (J20, on the lower side of the baseboard)
- ▶ 2x M.2 (J13 and J18; 2x B type)
- ▶ 1x PCIe x4 socket for expansion via riser cards
- ▶ 1x USB3.0 port for e.g. connection of USB dongles (J14)
- ▶ MicroSIM and MicroSD card combo connector (J28)
- ▶ CR2032 coin battery (J29)

### Optional System Extension:

- ▶ Optional fan tray
- ▶ LTE: via internal factory mounted adapter module
- ▶ WiFi: via corresponding internal factory mounted adapter module (X206)

The KBox C-103-NGSF is a fanless system with a compact metal chassis with cooling fins which can be optionally equipped with a fan tray for active cooling

The rated voltage range of the mains can be found on the type label. The type label is located at the right side of the device (Figure 17, pos. 9).

### NOTICE

The KBox C-103-NGSF is designed to be operated wall mounted inside a control cabinet, in vertical position, except with the top side facing down.

When you power on the KBox C-103-NGSF, make sure that the air exhaust openings on the top side (Figure 19, pos. 12), the air intake openings on the bottom side (Figure 20, pos. 11) and the cooling fins of the

---

chassis (Figure 18, Figure 19 and Figure 20, pos. 6) are not obstructed (covered) by any objects.

To provide sufficient heat dissipation via the cooling fins of the device, do not cover the cooling fins of the KBox C-103-NGSF. Do not place any objects on the device. When installing the system, please observe the clearance recommendation (keep out area) in the subsection 7.2 "Control Cabinet Mounting".

---

### 3.1. Optional RTC Lithium Battery (internally-accessible)

Your KBox C-103-NGSF can be optionally equipped with an internally-accessible lithium battery (CMOS) (see Figure 33). The battery and the battery holder can be accessed after removing the topside access cover (see chapter 5.2 "Opening and Closing the KBox C-103-NGSF").

For replacing the lithium battery, please follow the corresponding instructions in the section 9.1 "Replacing the Lithium Battery".

## 3.2. System Expansion Capabilities

### 3.2.1. M.2 Interfaces

The KBox C-103-NGSF is equipped with two M.2 interfaces on the KBox C-103-NGSF baseboard. The M.2 interface connectors are located on the top side of the baseboard and are accessible after removing the side access cover. There are two B type interfaces, one for 2280, 2260 and 2242 modules and one for 2242/3042 and 2230/3030 modules. Refer also to the subsection 5.2.4 "Installing/Removing an M.2 Module".

Refer to section 7.1 "Specifications of the internal M.2 Connectors" and the descriptions in this manual.

### 3.2.2. Mini PCI Express® Interface

The KBox C-103-NGSF is equipped with a Mini PCIe interface on the KBox C-103-NGSF baseboard. The Mini PCIe interface connector is located on the lower side of the baseboard and is not accessible in the field. This interface connector is intended to be used for Fieldbus or WiFi expansion. If a customer requires this system expansion, it must be selected when ordering, as this expansion has to be carried-out at factory. Refer also to the subsections 5.2.1.

Refer to section 11/ "Technical Specifications" and the descriptions in this manual.

### 3.2.3. Standard PCI Express® Interfaces

The baseboard of KBox C-103-NGSF provides 1x PCIe x4 interface. Via riser card there is one available PCIe expansion slot available.

### 3.2.4. SATA Interfaces

The baseboard of KBox C-103-NGSF provides 2 SATA interfaces. These allow the installation of up to two internal 2.5" SATA HDDs/SSDs or optional front accessible drive bays for 2.5" SATA HDDs/SSDs (refer to the subsection 3.3.11 "Internal or Removable 2.5" SATA HDDs/SSDs").

### 3.2.5. Internal USB 3.0 Interface

The baseboard of KBox C-103-NGSF provides one USB3.0 interface (USB A header) and space for a USB A module. This connector can be used to install an internal USB device e.g. a USB Dongle.

### 3.2.6. Internal microSD Card and microSIM Card Interface

The baseboard of KBox C-103-NGSF provides a microSD/microSIM combo interface. This allows the installation of of one microSD card and one microSIM card.

For installing/removing a micro SD or microSIM card, refer to chapter 5.2.5 "Installing/Removing a microSD/microSIM Card".



Figure 2 to Figure 8: Views of a KBox C-103-NGSF

Figure 2: Bottom side view

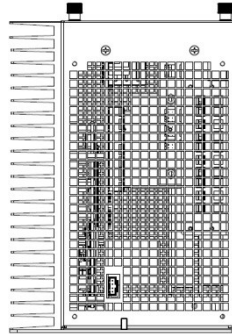


Figure 3: Right side view

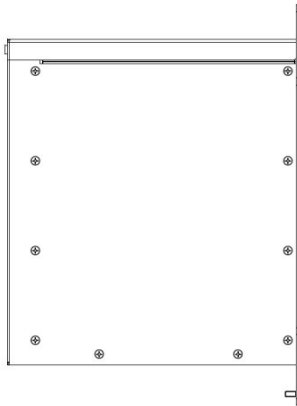


Figure 4: Front side view config. with removable drives



Figure 5: Front side view config. without removable drives



Figure 6: Left side view

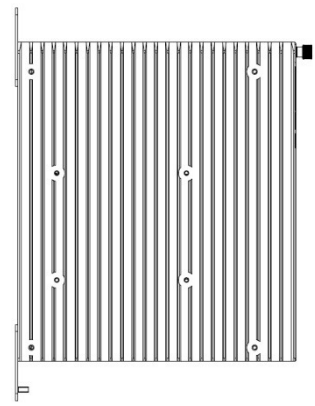


Figure 7: Top side view

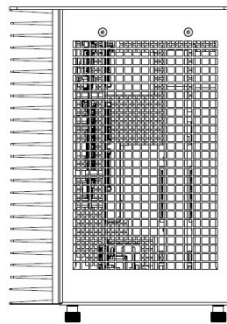
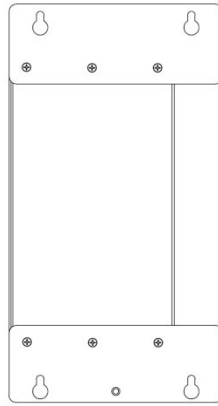
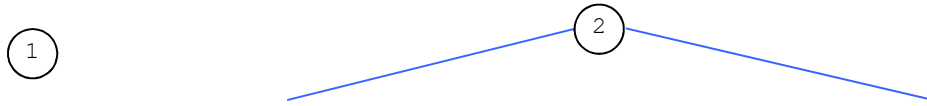


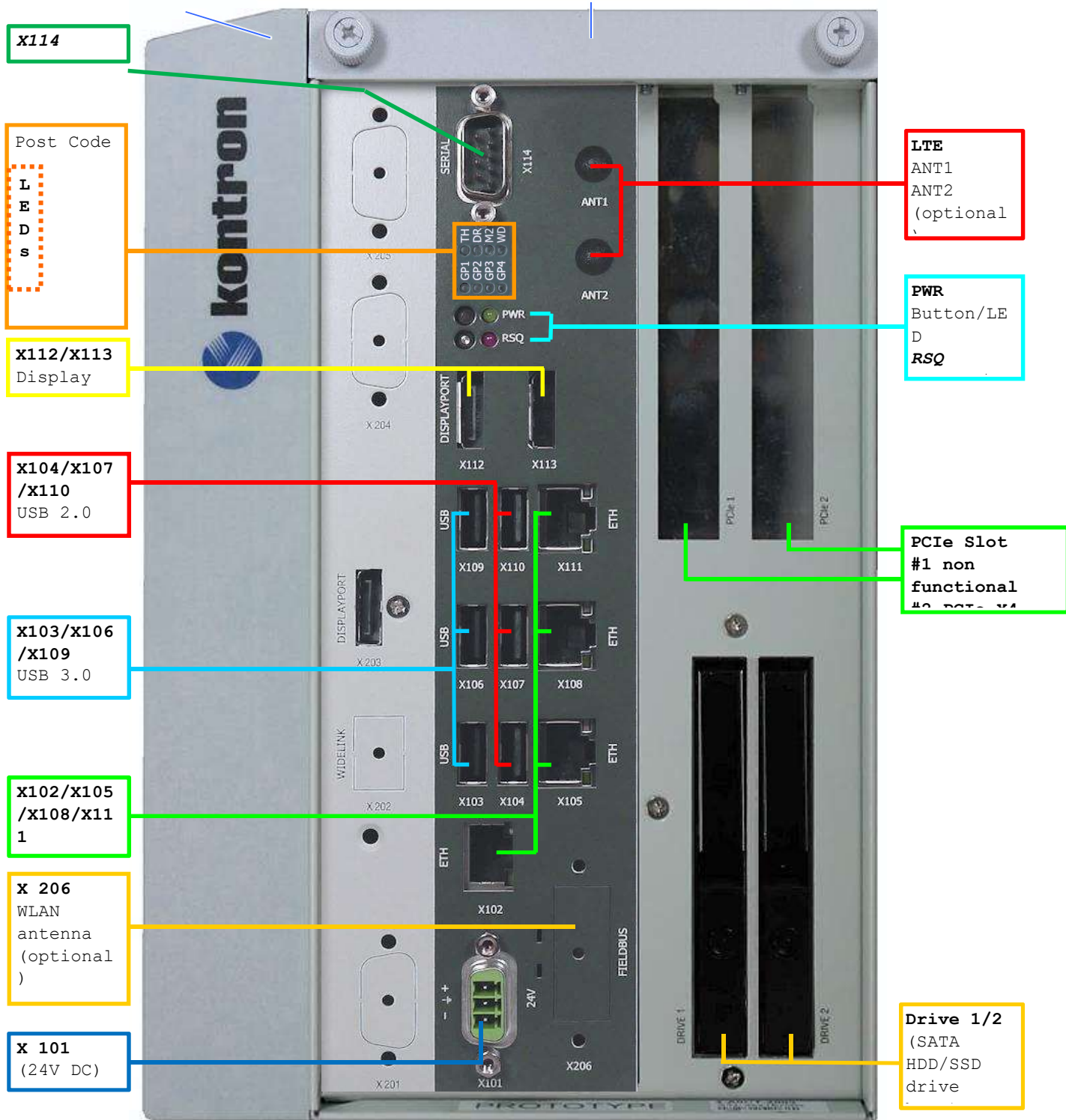
Figure 8: Rear side view



### 3.3. KBox C-103-NGSF Variant

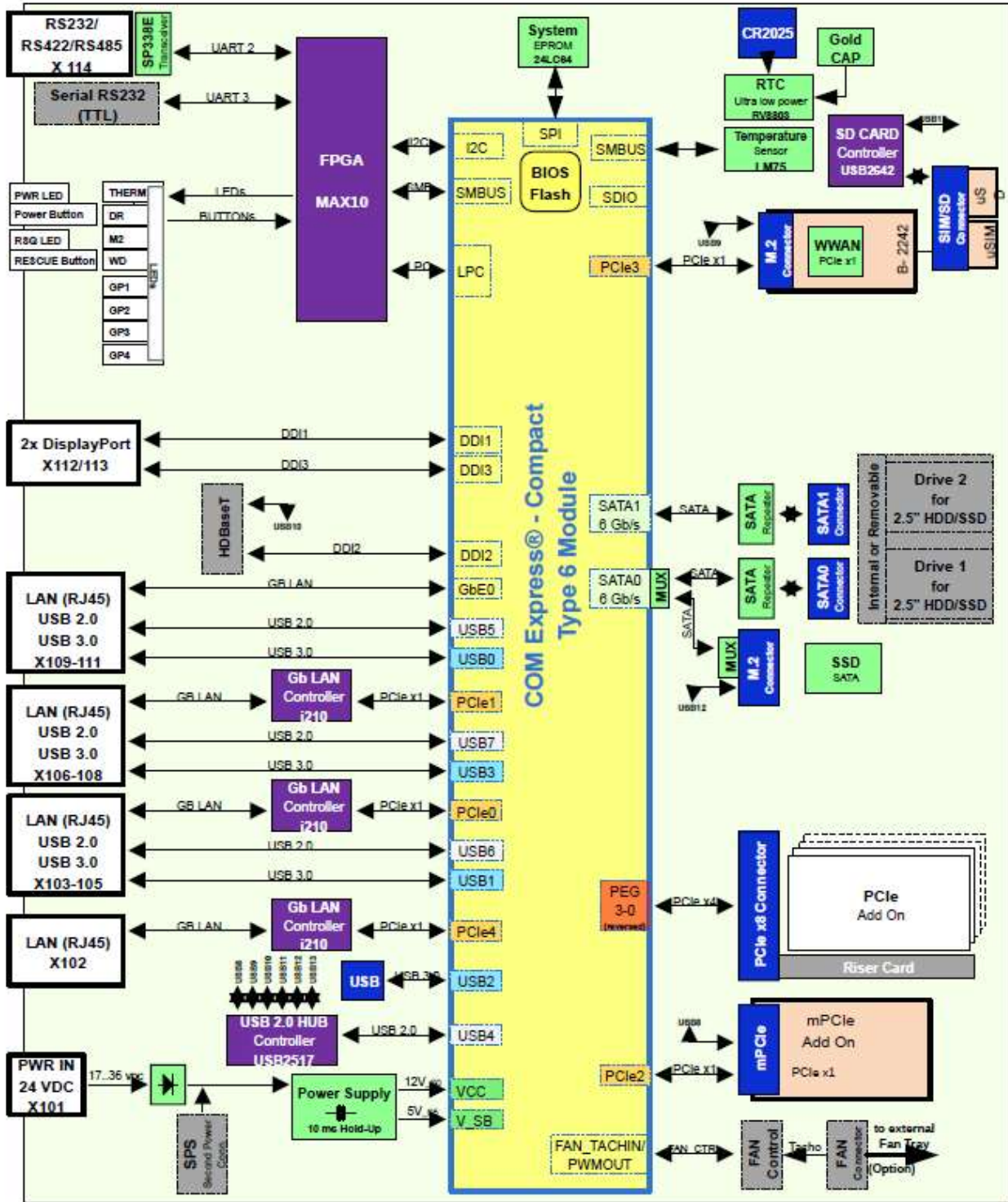
Figure 9: KBox C-103-NGSF - front view (shown with removable drive bays and without mounting brackets)



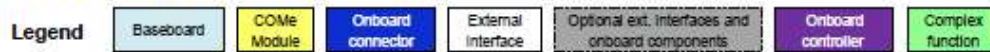


1. Side of KBox C-103-NGSF with cooling fins
2. Top side cover with knurled screws

Figure 10: Block Diagram - KBox C-103-NGSF-x



KCBASE Baseboard Rev. 1.0 for cTL6



### 3.3.1. X101/X201 - Power Input Connectors

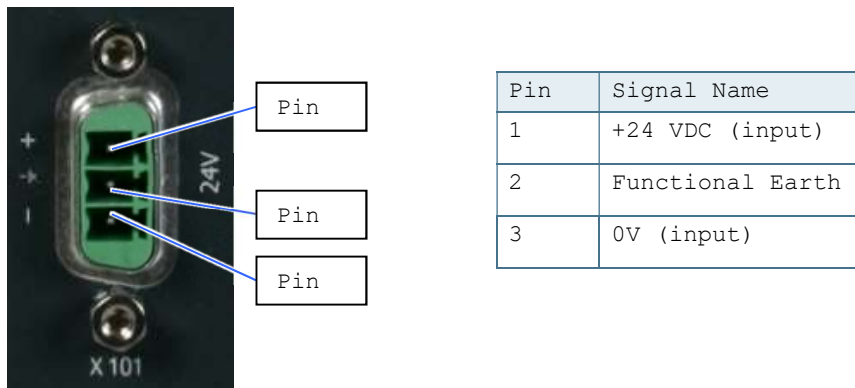
The 3-pin connector (X101) and the optional second power connector (X201) provide the power connection of the KBox C-103-NGSF system to an appropriate DC main power supply (see Figure 11 and Figure 9). For pin assignment refer to the subsection 12.1.1.



If a second power supply is connected to the KBox C-103-NGSF, only the particular power supply with the higher supply voltage will be used (no power sharing), the other power supply is redundant. Active and redundant power supply can change during operation without interruption.

The external cable connector is a Phoenix PSC 1,5/ 3-M, 3-pin plug with an SCT-D-SUB 9-KG housing. This power plug is delivered along with the KBox C-103-NGSF. Please observe the section 8.1 "Connecting to DC Main Power Supply". The mating connector is a Phoenix PSC 1,5/ 3-F connector.

Figure 11: X101 - 24VDC power input connector



### 3.3.2. X102/X105/X108/X111 - Ethernet Connectors (ETH)

These connectors (X102/X105/X108/X111, Figure 9) are Gigabit Ethernet 10/100/1000 Mbit/s, IEEE 1588 capable interfaces. X111 is connected to the COMe i225 NIC and can be operated also at 2.5GB.

The connectors are standard 8-pin RJ45 type connectors with status LEDs:

- ▶ *Activity/link: green = link up; green blinking = activity.*
- ▶ *Speed: off, green, yellow (10/100/1000 Mbit/s).*

For pin assignment refer to subsection 12.1.2.

### 3.3.3. X103/X106/X109 - USB 3.0

The KBox C-103-NGSF provides three USB 3.0/2.0 interfaces. These connectors (X103/X106/X109, Figure 9) allow connection of USB 3.0 or USB 2.0 compatible devices to the system. The maximum current available depends on the ambient temperature: Below 40°C it is 1 A (100%), above 40°C there is a derating of 2.5% per degree. So at 60°C the maximum current available is 500 mA (50%). For pin assignment refer to subsection 12.1.3.

### 3.3.4. X104/X107/X110 - USB 2.0

The KBox C-103-NGSF provides three USB 2.0/1.1 interfaces. These connectors (X104/X107/X110, Figure 9) allow connection of USB 2.0 or USB 1.1 compatible devices to the system. The maximum current available depends on the ambient temperature: Below 40°C

it is 500 mA (100%), above 40°C there is a derating of 2.5% per degree. So at 60°C the maximum current available is 250 mA (50%). For pin assignment refer to subsection 12.1.4.

### 3.3.5. X112/X113/X203 - DisplayPorts

The KBox C-103-NGSF provides DisplayPort compliant interfaces realised using two (optional: three) standard DisplayPort connectors. External (digital) displays can be connected to the DisplayPort connectors (X112/X113, optional: X203, Figure 9). For pin assignment refer to subsection 12.1.5.

### 3.3.6. X114 - RS232 Port

The RS232 interface (X114, Figure 9) is provided as a 9-pin D-SUB connector. It allows you to connect a serial device to the system. Support of this connector depends on the BIOS version.

For pin assignment refer to subsection 12.1.6.

### 3.3.7. POWER Button and PWR LED

Figure 12: Detail - Power button and PWR LED/Rescue button and RSQ LED



The power button (PWR, Figure 12, pos. 1, Figure 9) is used to power the KBox C-103-NGSF on or off.

By pressing the power button for longer than four seconds a forced system shutdown will be initiated, before the power to the system is turned off.

#### **NOTICE**

Caution: Performing a forced shut down can lead to loss of data or other undesirable effects!

The power LED (marked PWR, Figure 12, pos. 2, Figure 9) is on green steady when power is applied to the system.

#### **Prerequisite:**

The KBox C-103-NGSF has to be connected to an appropriate main power supply (DC).

#### **⚠ WARNING**

Even when the system is turned off via the power button there are parts of the system still energized.  
The unit is only completely disconnected from the DC mains, when the power is removed.

As soon as external power is applied to the main input power connector X101 (Figure 11) or to the optional second power connector X201 (Figure 9), the KBox C-103-NGSF boots up and then starts the operating system and application where available.

To perform an orderly shutdown of the system, press the PWR button and the system shuts down under the control of the operating system.

Once the system has been shut down, it can be restarted by pressing the PWR button (assuming that power is still applied to the main input power connector, X101).

### 3.3.8. RESCUE Button and RSQ LED



The rescue function is not working on this version

### 3.3.9. Status and General Purpose LEDs

The 8 LEDs are only showing the BIOS post code!

Figure 13: Detail - Status and General Purpose LEDs

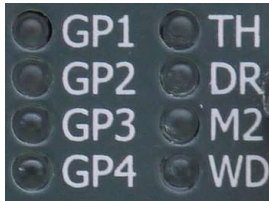


Table 2: Status and General Purpose LEDs

Status and General Purpose LEDs				
Designator	Function	Color	Description	Post Code
TH	Thermal	Green	Normal operation	Bit #7 MSB
		Red blinking	The system turns off due to over temperature	
DR	Drives (SSD/HDD)	Green	SSD/HDD active	Bit #6
M2	M.2 2242 Card	Green	M.2 card active	Bit #5
WD	Watchdog	Red blinking	Watchdog timeout occurred	Bit #4
GP1	General Purpose 1	Red/Green/Orange	User general purpose 1	Bit #3
GP2	General Purpose 2	Red/Green/Orange	User general purpose 2	Bit #2
GP3	General Purpose 3	Red/Green/Orange	User general purpose 3	Bit #1
GP4	General Purpose 4	Red/Green/Orange	User general purpose 4	Bit #0 LSB

### 3.3.10. PCI/PCIe Expansion Slots

The KBox C-103-NGSF provides on the front side two slots (see also Figure 9 for KBox C-103-NGSF) for system expansion with PCIe expansion card via riser card.

**PCIe Slot 1 is not functional!**

Use only Slot two for PCIe expansion cards!



### 3.3.11. Internal or Removable 2.5" SATA HDDs/SSDs

Depending on the ordered system configuration, your KBox C-103-NGSF can be equipped with up to two drive bays for 2.5" removable SATA HDDs/SSDs (refer to Figure 9, Figure 10) or one internal mounting frame for 2x 2.5" SATA HDDs/SSDs. The drive bays are suitable for 9.5 mm SSDs and 7 mm SSDs (with adapter).

The internal 2.5" HDDs/SSDs are not accessible from the outside. The internal SATA HDDs/SSDs are installed (always factory installed) into the system by use of a mounting frame.

The 2.5" drive bays (DRIVE 1 and DRIVE 2) for removable HDDs/SSDs are accessible from the front side (Figure 9) of the system (refer to Figure 14, Figure 15 and Figure 16).

The drives support following drive speeds:

- ▶ DRIVE 1: up to SATA 6 Gb/s.
- ▶ DRIVE 2: up to SATA 6 Gb/s.



If the KBox C-103-NGSF configuration with internal 2.5" SATA HDDs/SSDs was ordered, the "DRIVE 1" and "DRIVE 2" for removable SATA HDDs/SSDs are not available (refer to Figure 5).

If the KBox C-103-NGSF configuration with removable 2.5" SATA HDDs/SSDs was ordered, no installation of any internal SATA HDD/SSD (with mounting frame) is possible.

Refer also to the area marked "D" in the section 3.3.

Figure 14: Drive 1 and Drive 2 for removable 2.5" SATA HDD/SSD (option); closed drive bays

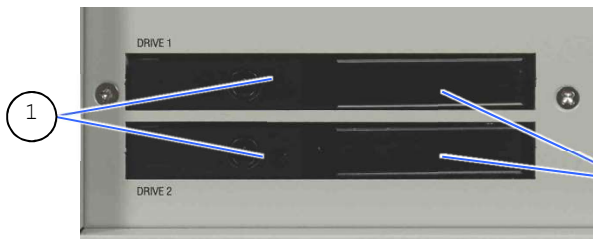


Figure 15: Drive bay 1 with opened drive bay cover

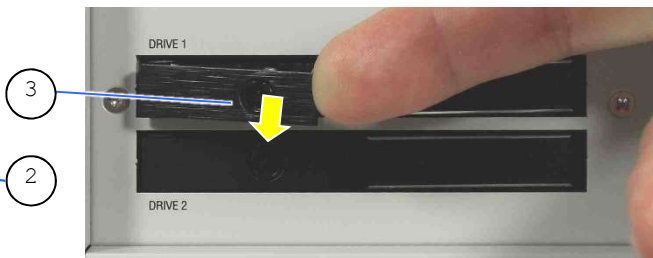
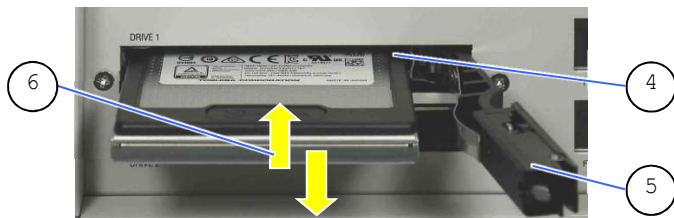


Figure 16: Inserting/removing a 2.5" removable SSD



This SATA interface supports hot-swapping. To prevent data loss, don't remove the HDD during read/write activity

- 1 Lockable lever to release the drive bay cover
- 2 Cover of the drive bay
- 3 Pulled-out lever

- 4 Drive bay for 2.5" removable SATA HDD/SSD
- 5 Opened drive bay cover
- 6 Inserting or removing a 2.5" removable SATA HDD/SSD

### 3.3.11.1. Installing/Removing the removable HDD/SSD

To install/remove a removable drive, please perform the following steps:

1. Pull out the lever (Figure 15, pos. 3) of the drive cover (Figure 14, pos. 2) and release it. (If required, unlock the lever with the corresponding key before.)
2. The drive bay cover will spring open and the removable drive will automatically slide out a bit.
3. Insert/remove the drive into/out from the bay receptacle.
4. Close the cover.

### 3.4. Left and Right Side View

Figure 17: Right side of the KBox C-103-NGSF system

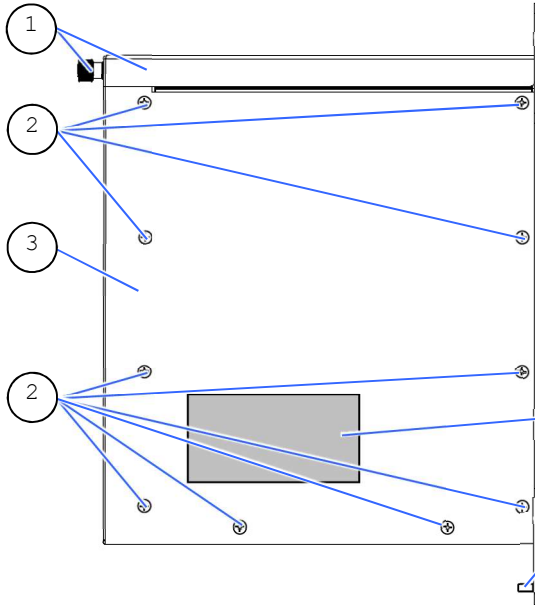
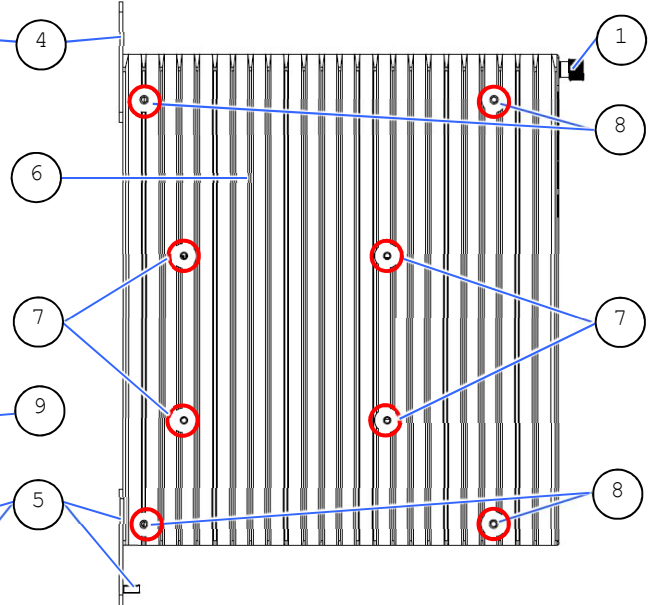


Figure 18: Left side of the KBox C-103-NGSF system



- 1 Top side access cover with knurled screws
- 2 10x screws that secure the right side access cover
- 3 Right side access cover
- 4 Upper mounting bracket with key holes
- 5 Lower mounting bracket with M4 ground stud and key holes
- 6 Cooling fins of the chassis

- 7 Screws that secure the COMExpress® module
- 8 Screws that secure the cooling fins to the chassis
- 9 Type label
- 10 Hole for further system fan tray extension
- 11 Air intake openings on the bottom cover
- 12 Air exhaust openings on the top cover

**NOTICE**

Please do not remove the red marked screws (see Figure 18, pos. 7 and pos. 8).

### 3.5. Top and Bottom Side View

Figure 19: Top side of the KBox C-103-NGSF system

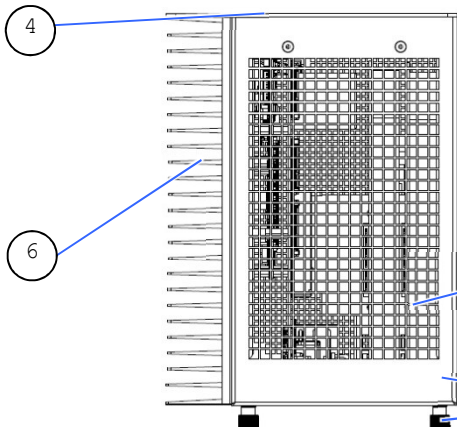
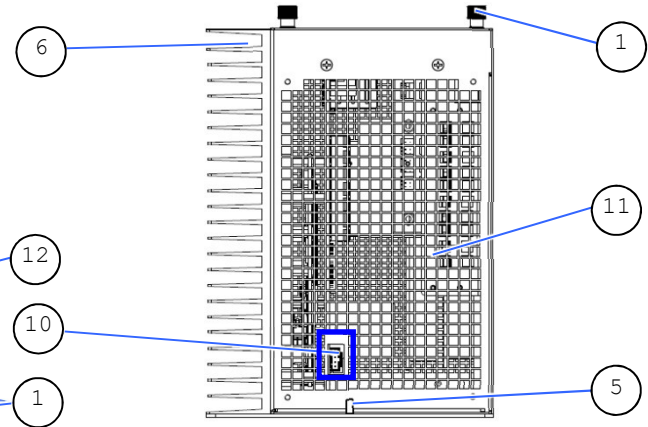


Figure 20: Bottom side of the KBox C-103-NGSF system



**NOTICE**

When powering on the KBox C-103-NGSF, make sure that the air intake and exhaust openings are not obstructed. To provide sufficient heat dissipation for the cooling of the KBox C-103-NGSF system, never cover the cooling fins of the chassis. Do not place any objects onto the device.

### 3.6. Rear Side View

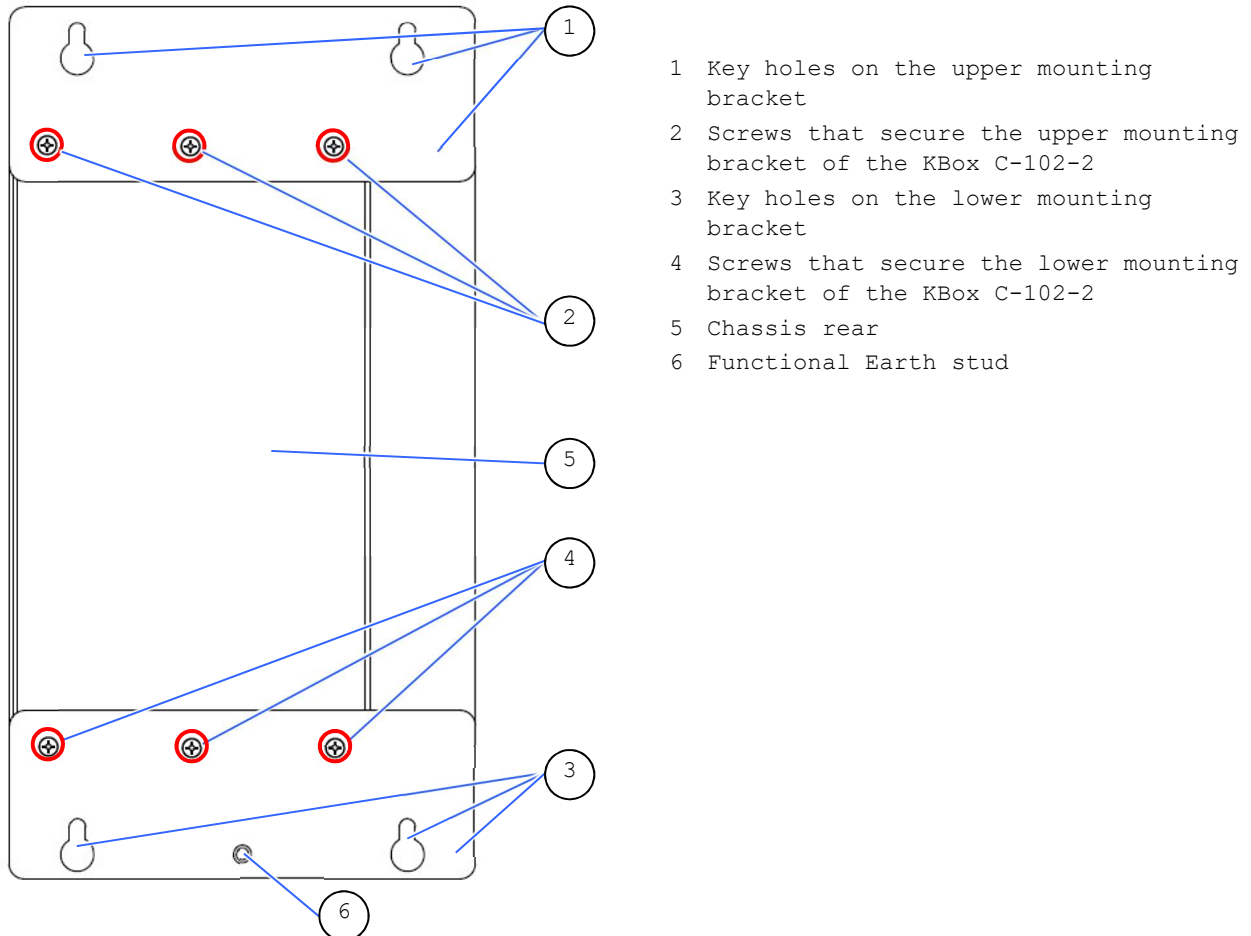
The KBox C-103-NGSF is designed for wall mounting, in vertical position inside of a control cabinet.



Please do not remove the red marked screws (see Figure 21, pos. 2 and pos. 4).

Please observe the mounting instructions included in the chapter 7/ "Installation Instructions"

Figure 21: Rear side of the KBox C-103-NGSF system



### 3.7. Functional Earth Stud

There is an M4 functional earth terminal on the lower mounting bracket of the KBox C-103-NGSF (Figure 21, pos. 6). This terminal may be connected as required.

**NOTICE**

The KBox C-103-NGSF with the stud marked with a "Functional Earth" symbol (Figure 21) has to be grounded to an appropriate "common earth" connection point.

---

## 4/ System Extensions

Optionally your KBox C-103-NGSF can be equipped by factory only, with following ports and additional components:

- ▶ *Fan Tray: an additional component connected to the KBox C-103-NGSF-4, KBox C-103-NGSF and KBox C-103-NGSF-1*

You have to order these components separately, in order to extend your KBox C-103-NGSF at the factory.

Example of system configuration, see below:

### 4.1. (X203) - 3<sup>rd</sup> DisplayPort

Your KBox C-103-NGSF can optionally be extended with a third DisplayPort

The DP 3 port is a DisplayPort compliant interface realized using a standard DisplayPort connector. An external (digital) display can be connected to the DisplayPort .

For pin assignment refer to subsection 12.1.5.

### 4.2. (X206) WiFi

#### 4.2.1. WiFi/BT

To add a WiFi/BT functionality to the system, the mPCIe socket (on the bottom of the baseboard), will be used. This connection can be implemented at factory only. The WiFi antennas will use the brake-out X206.

Table 3: WiFi/BT Expansion Card Option

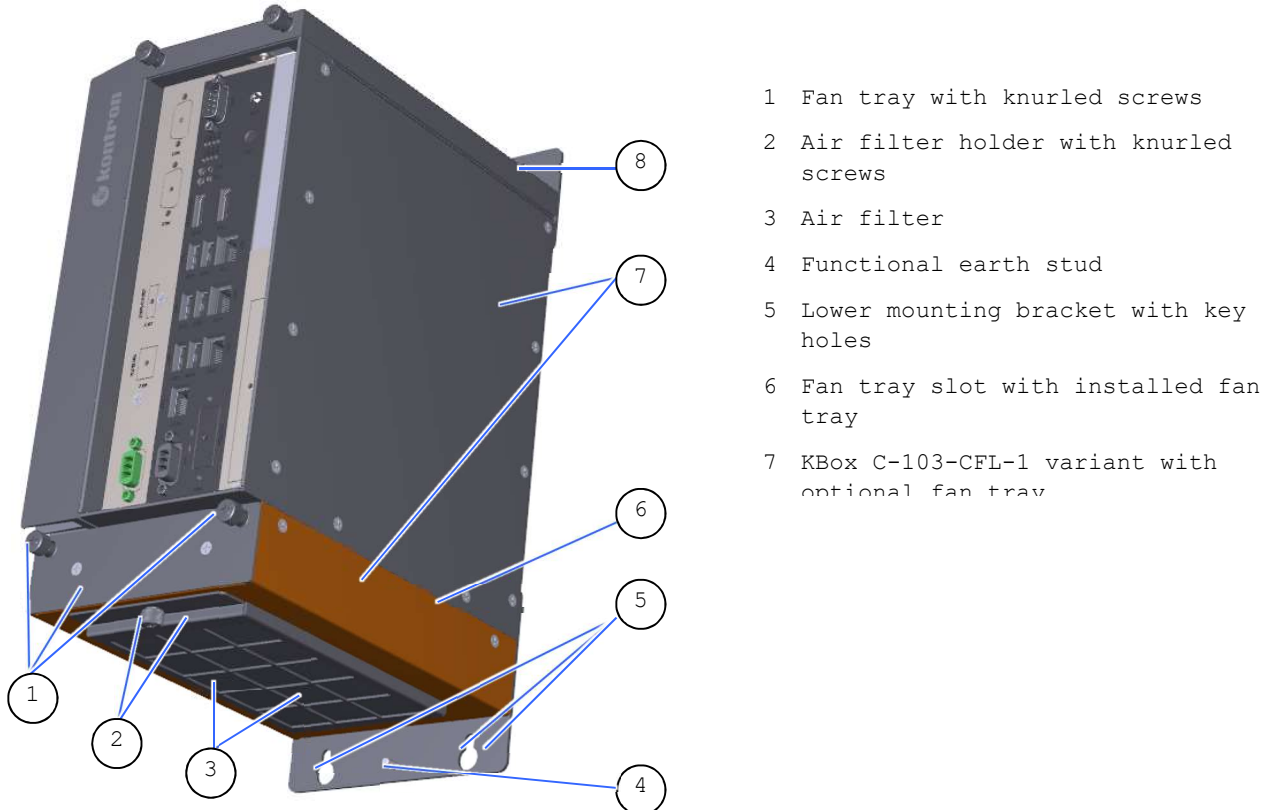
Expansion slot	Description
1x Wi-Fi mPCIe (half-size)	Dual band frequencies (2.4 GHz & 5 GHz) Bluetooth (BT) 4.1+HS IEEE802.11 ac/abgn Wi-Fi certified Speeds 300 Mbps max. on N & 867 Mbps on AC

### 4.3. Optional Versions with Fan Tray - KBox C-103-NGSF

By using a fan tray, the KBox C-103-NGSF can be operated in a control cabinet with extended ambient temperature; refer to the specified values in the section 11.2 "Environmental Specifications" and chapter 6/ "Power and Thermal Considerations".

The KBox C-103-NGSF with fan tray chassis extension is designed to provide a better airflow through the system chassis.

Figure 22: KBox C-103-NGSF-1 equipped with the optional fan tray



The fan is integrated in a user-friendly, replaceable fan tray (hot-swapping). The fan tray is designed to be inserted into the fan tray slot (Figure 22, pos. 6) on the bottom side of the KBox C-103-NGSF. The fan tray simplifies the installation and removal of this component, even during operation.

The fan rotation speed is temperature controlled in dependence on the CPU temperature. Thus, a reliable air circulation for optimal active cooling of the KBox C-103-NGSF is ensured.

The temperature conditions of the system (depending on the environmental temperature and the system load) are detected by the CPU temperature sensor.

In order to ensure a clean air circulation through the system, the fan tray slot provides an installed air filter (Figure 22, pos. 3).

The air filter, which protects your system against dust and dirt, is washable and may be replaced during operation; refer to subsection 9.4 "Cleaning the Air Filter".

## 5/ Accessing Internal Components

This chapter contains important information that you must read before accessing the internal components. You must follow these procedures properly when installing, removing or handling any system component.

It is recommended to expand your system with additional PCIe/M.2 cards before it is installed into an industrial control cabinet. Please consider following instructions when you install or remove expansion cards.

**Before installing/removing an expansion card, please pay attention to the following information:**

### **⚠ WARNING**

Please observe the "General Safety Instructions for IT-Equipment" provided with the system (refer also to the chapter 1/) and the installation instructions contained in this manual. The KBox C-103-NGSF system shall be mounted into a control cabinet.

Only personnel with appropriate qualifications, trainings and authorization are permitted to install and work with the KBox C-103-NGSF system.

The installation/removal of HDDs/SSDs and/or expansion cards may only be performed by a qualified person, according to the description in this manual.

Before removing the cover of the device, make sure that the device is powered off and disconnected from the power supply.

Before you upgrade the KBox C-103-NGSF with expansion cards, pay attention to the power specifications in chapter 11/ "Technical Specifications" and make sure that the power consumption of the expansion cards does not exceed 15 W per card.



Please follow the safety instructions for components that are sensitive to electrostatic discharge (ESD). Failure to observe this warning notice may result in damage to the device or/and internal components.



Please pay attention to the manufacturer's instructions before installing/removing an expansion card.



## 5.1. Top Cover



The pictures in this section correspond to a KBox C-103-NGSF system. The cover description can be applied to all system variants, under consideration of the different mechanical specifications of the KBox C-103-NGSF

### **WARNING**

**When used as intended the KBox C-103-NGSF is to be operated only in closed condition.**

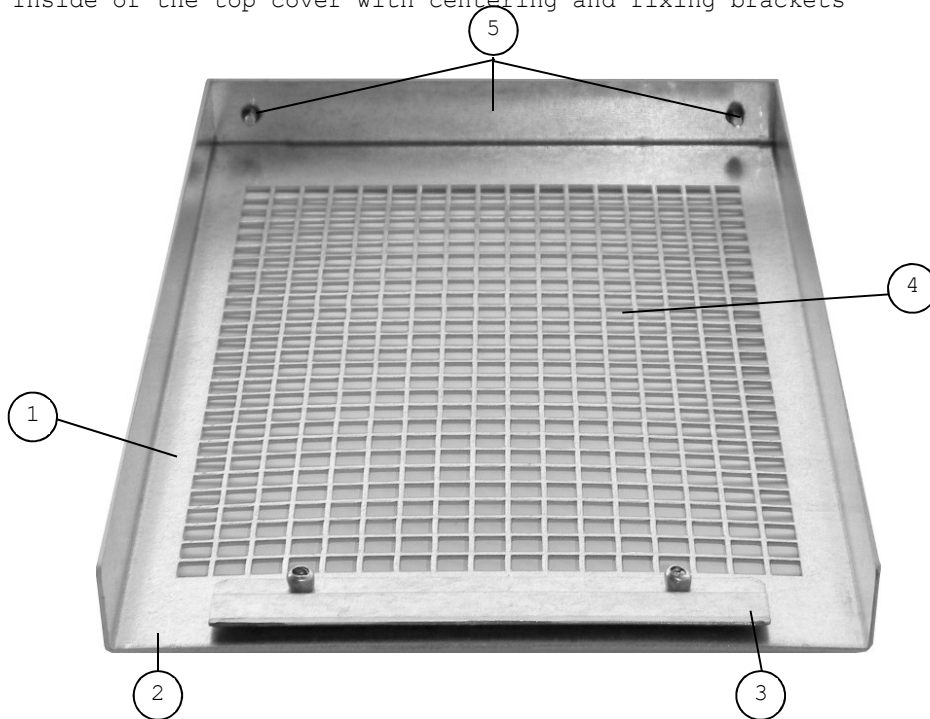
Only when the right side cover is fixed with the screws (Figure 17, pos. 2) and top cover is properly installed and secured with the knurled screws (Figure 9, pos. 2) on the front side, it is ensured that the user doesn't have access to the internal components of the KBox C-103-NGSF during operation.

The cover will be fixed to the chassis using the centring bracket at the rear side of the cover (Figure 23, pos. 3) and the fixing bracket with captive knurled screws at the front side of the cover (Figure 23, pos. 5).

When inserting the cover, make sure that:

- ▶ *At the rear: the centring bracket (Figure 23, pos. 3) is inserted properly into the corresponding cover retaining bracket of the chassis*
- ▶ *At the front side: the fixing bracket with captive knurled screws of the cover (Figure 23, pos. 5), is matching properly over the cover retaining bracket on the front side*
- ▶ *The fixing bracket with captive knurled screws (Figure 23, pos. 5) secures the top cover on the front side (Figure 9, pos. 2).*

Figure 23: Inside of the top cover with centering and fixing brackets



- |   |                            |   |  |
|---|----------------------------|---|--|
| 1 | Inside of the top cover    | 3 | Centering bracket (on the rear side)                 |
| 2 | Rear part of the top cover | 4 | Air exhaust openings                                 |
|   |                            | 5 | Fixing bracket with knurled screws on the front side |

## 5.2. Opening and Closing the KBox C-103-NGSF

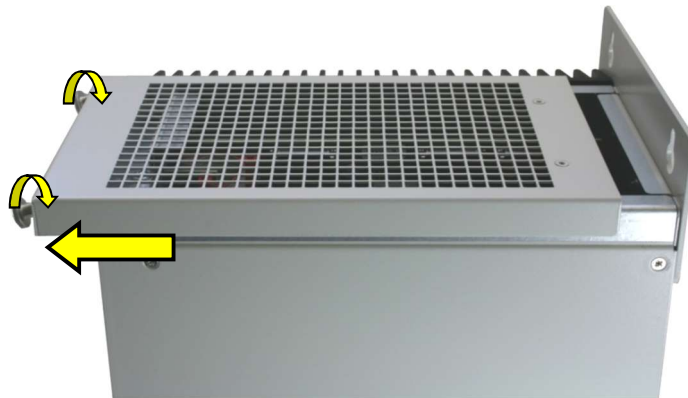
For opening/closing the KBox C-103-NGSF, please perform the following steps:

### **⚠ WARNING**

The system must be powered off and disconnected from the main power supply, before you attempt to open the KBox C-103-NGSF. Ensure that you have a clean, flat and ESD-safe surface to work on. Also disconnect all peripheral devices from the KBox C-103-NGSF. Please observe the instructions contained in the chapter 7/ "Installation Instructions".

1. Close all applications. Shut down the system properly and disconnect the connection to the power source.  
Disconnect all peripherals.
2. The KBox C-103-NGSF should lay on a flat, clean surface with the top side facing upwards.
3. Loosen the knurled screws, which secure the top cover on the front of the system (see Figure 9 and Figure 24).
4. Pull the cover out a little bit, as shown in Figure 24, to release the cover centering and fixing brackets.

Figure 24: Removing the centering and fixing bracket of the top cover (detail of the KBox C-103-NGSF)

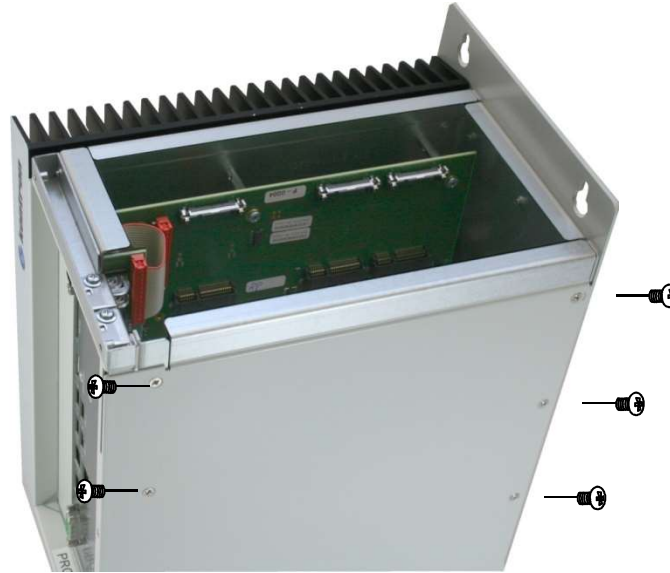


5. Lift the top cover up (on the front edge) and remove it (Figure 25). Now you have access to the internal sockets (PCI/PCIe/M.2) or to the corresponding cards/devices, in order to install or remove internal hardware components.

Figure 25: Removing the cover (detail of the KBox C-103-NGSF)

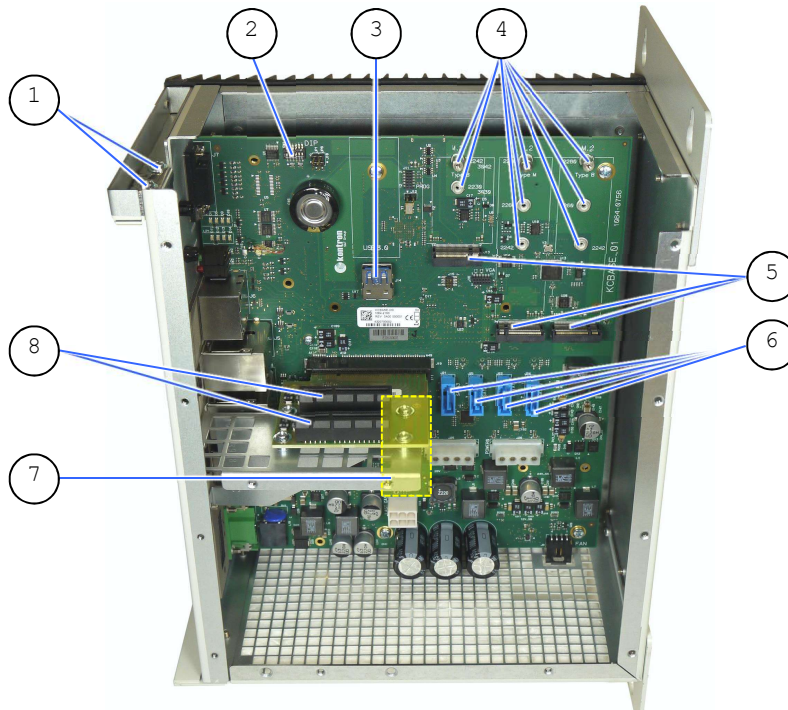


Figure 26: KBox C-103-NGSF - removing the right side cover



6. For a better accessibility of the internal sockets (PCIe and M.2 modules), you may also remove the right side cover of the KBox C-103-NGSF (Figure 26). Loosen the externally accessible fastening screws (Figure 17, pos. 2) that secure the right side cover (Figure 26 and Figure 17, pos. 3). Pull the right side cover out, to detach it from the sideways mounted bolts. Put the right side cover and the screws aside for later use.

Figure 27: KBox C-103-NGSF without top and right side cover (shown with a PCIe riser card)



- |   |   |   |  |
|---|---|---|--|
| 1 | Screws to fix the PCIe slot bracket or the I/O bracket of the PCIe card | 5 | 3x M.2 sockets (2x Type B, 1x Type M; from left to right: J13, J17, J18) (J17: non functional) |
| 2 | DIP switch  | 6 | 4x SATA connectors (SATA2&3 non functional!)   |
| 3 | Internal USB 3.0 port with space for module                             | 7 | 1x Mini PCIe socket for PCIe Mini card (J20) ( <i>not visible; obstructed by riser card</i> )  |
| 4 | Threaded holes/fixing bolts to secure the 3x M.2 modules                | 8 | Riser card with 2x PCIe x4 sockets   |

### 5.2.1. DIP Switch

The baseboard of the KBox C-103.CFL is equipped with an DIP switch (Figure 27, pos. 2). Which is non-functional

### 5.2.2. Expansion Socket for PCIe Mini Cards

Depending on the system configuration ordered, your KBox C-103-NGSF can be extended with a PCIe Mini card.



---

The KBox C-103-NGSF provides one internal Mini PCIe socket for PCIe Mini cards. The Mini PCIe socket is on the lower side of the baseboard and can be only at factory equipped with an expansion card.

---

### 5.2.3. Riser Cards Expansion Sockets for PCI/PCIe Cards

The Riser card in the system only supports the second slot. The first slot is non-functional!

#### 5.2.4. Installing/Removing an M.2 Module

To install an M.2 module please proceed according to the steps described:

1. Close all applications; shut down the system properly and disconnect the connection to the power source.  
Disconnect all peripherals.
2. Open the device as described in the subsection 5.2 "Opening and Closing the KBox C-103-NGSF" (step 1-6).
3. Locate the M.2 sockets and the corresponding fixing bolts. (Figure 27, pos. 4 and 5).
4. Mount the fixing bolts at the correct position for the length of the M.2 card, using the threaded holes (Figure 27, pos. 4)
5. Insert the M.2 card into the corresponding socket (Figure 27, pos. 7) at an angle of approx. 45° and push it down until it lies on the the fixing clip.
6. Secure the M.2 on the fixing bolt with the corresponding fixing screw.
7. In order to close the KBox C-103-NGSF, proceed in reverse order (step 6 to 1 of the section 5.2 "Opening and Closing the KBox C-103-NGSF").

To remove an M.2 module, please proceed according to the steps described:

1. Close all applications; shut down the system properly and disconnect the connection to the power source.  
Disconnect all peripherals.
2. Open the device as described in the subsection 5.2 "Opening and Closing the KBox C-103-NGSF" (step 1-6).
3. Locate the M.2 card installed into your system.
4. Remove the fixing screw in order to release the M.2 card. It will spring up at an angle of approx. 45° on the fixing clips side.
5. Gently pull the M.2 card out.
6. In order to close the KBox C-103-NGSF, proceed in reverse order (step 6 to 1 of the section 5.2 "Opening and Closing the KBox C-103-NGSF").




---

##### Preventive Maintenance for M.2 SSDs:

Because of the limited predetermined lifespan of SSDs, we recommend to check the condition of your installed SSD drives via S.M.A.R.T. regularly.

Pay attention to the manufacturer specifications for lifespan.

---

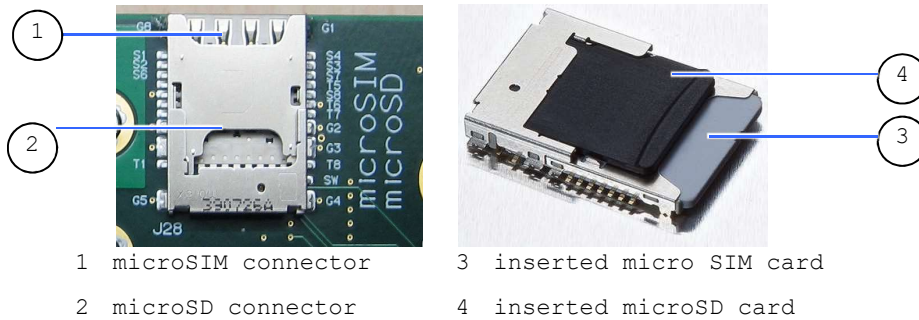
See also section 7.1 "Specifications of the internal M.2 Connectors".

### 5.2.5. Installing/Removing a microSD/microSIM Card

To install a microSD or a microSIM card, please proceed according to the steps described:

1. Close all applications; shut down the system properly and disconnect the connection to the power source.  
Disconnect all peripherals.
2. Open the device as described in the subsection 5.2 "Opening and Closing the KBox C-103-NGSF" (step 1-6).
3. Locate the microSD/microSIM combo connector at the rear side of the baseboard

Figure 28: microSD/microSIM combo connector



4. Insert a microSIM card into the the microSIM connector or/and insert a microSD card int the microSD connector by gently pushing the card into the corresponding connector, card contacts facing down (see
5. Figure 28).
6. In order to close the KBox C-103-NGSF, proceed in reverse order (step 6 to 1 of the section 5.2 "Opening and Closing the KBox C-103-NGSF").

To remove a microSD or a microSIM card, please proceed according to the steps described:

1. Close all applications; shut down the system properly and disconnect the connection to the power source.  
Disconnect all peripherals.
2. Open the device as described in the subsection 5.2 "Opening and Closing the KBox C-103-NGSF" (step 1-6).
3. Locate the microSD/microSIM combo connector at the rear side of the baseboard
4. Gently pull the microSD/microSIM card out.
5. In order to close the KBox C-103-NGSF, proceed in reverse order (step 6 to 1 of the section 5.2 "Opening and Closing the KBox C-103-NGSF").



## 6/ Power and Thermal Considerations

### 6.1. System Power Portfolio

Below information gives more insight on the power portfolio of KBOX C-103-NGSF:

- ▶ Overall Maximum Power Consumption: **140 Watt**
- ▶ Input Voltage Nominal 24 Volt DC, Maximum Range 17 - 36 Volt DC
- ▶ Holdup Time 10ms @ 100 Watt

Please find in below tables values to calculate the total needed power for the 24 Volt power supply depending on the application. Be aware that the DC power supply must be able to handle peak currents for several seconds.

Table 4: Power Consumption

Power Consumption	COMe	Carrier	USB 3.0	USB 2.0	M.2	MiniPCIe	Sata SSD	PCIe card
CPU	TDP		4 Conn.	3 Conn.	2 Slots	1 Slot	2 Pcs.	4 Slot
Intel® Core™	25 W	5 W	0-20 W	0-7.5 W	0-17 W	0-4 W	0-10 W	0-50 W
Intel® Core™	45 W	5 W	0-20 W	0-7.5 W	0-17 W	0-4 W	0-10 W	0-50 W

Table 5: Current and voltage provided in the KBOX C-103-NGSF per port

	USB 3.0	USB 2.0	M.2	MiniPCIe	Sata SSD
<b>Maximum defined Power per Port</b>	5 W	2.5 W	5.6 W	4 W	5 W
<b>Max current (Voltage) per Port</b>	1 A (5 V)	0.5 A (5 V)	1.7 A (3.3 V)	1 A (3.3 V)	1 A (5 V)
				375 mA (1.5 V)	1 A (12 V)

Table 6: Maximum Power supplied on the PCIe Slot

PCIe Expansioncard	Slot1	Slot 2	12 Volt	3.3 Volt
2 Slot PCIe X4	Non functional	25 W	2 A total	3 A total

### 6.2. Convection Cooling

The KBox C-103-NGSF is designed for convection cooling within the specified ambient air temperature ranges. Therefore it is imperative that air flow to and from the unit is guaranteed.

In addition, implementers must empirically verify the cooling concept for the KBox C-103-NGSF including optionally installed devices prior implementing the unit in the intended application.

### 6.3. Active Cooling via the optional Fan Tray

For applications where convection cooling is not sufficient, there is the possibility to use the optional fan tray. The optional fan tray extension allows to operate the system

at higher ambient temperature conditions and provides a higher air flow through the chassis providing a better cooling of the system internal components.

## 6.4. Minimum System Clearance

To provide a maximum of airflow through and around the box, minimum distances to surrounding parts must be observed (please refer to the subsection 7.2 "Control Cabinet Mounting" )

### Maximum Temperatures




---

The maximum system ambient temperature depends mostly on the power consumption of the processor, chipset and third party components:

- ▶ *Configurations with HDDs are limited to 50°C maximum ambient temperature.*
  - ▶ *Configurations with wireless components (LTE, WiFi) are limited to 60°C ambient temperature.*
- 




---

The processor utilization depends highly on the software used. Software using multicore feature will run on several cores whereas standard software will only utilise one core. In this case the processor will use the "Turbo Mode" to increase the clock for the core with the highest workload, as long as the temperature is within limits.

---

## 6.5. Third Party Components

When the KBox C-103-NGSF is extended and configured with third party components like PCIe extension cards and drives (HDD or SSD), it has to be taken into account that the air temperature inside the system is higher than the ambient temperature. An approximately internal temperature rise is given.

## 6.6. Processor Thermal Monitoring

The processor used with the KBox C-103-NGSF system provides internal thermal monitoring. Every core of the processor comprises a temperature sensor.

To allow an optimal operation and long-term reliability, the processor must operate in the specified temperature range. To avoid overheating the processor performs an automatic thermal management, which intends to keep the processor temperature below the highest value of the temperature range. This behavior is a CPU standard feature.

## 6.7. Processor Thermal Trip Feature

The Processor Thermal Trip feature protects the processor from catastrophic overheating. The Thermal Trip Tensor threshold is set well above the normal operating temperature to ensure that there are no false trips. The processor will stop all executions when the junction temperature exceeds approximately 125°C. This event will be indicated by the red blinking "Thermal" LED on the front panel. This behavior cannot be altered. Once activated, the event remains latched until power is cycled.

## 7/ Installation Instructions

The KBox C-103-NGSF comes with attached wall mount brackets. The available mounting key holes (Figure 21, pos. 1 and pos. 3) of the wall mounting brackets allow the unit attaching to a wall of a fire resistant enclosure.

**Please observe the following safety and installation instructions:**

- ▶ *Whenever possible, unpack or pack this product only at EOS/ESD safe work stations. Where a safe work station is not guaranteed, it is important for the user to be electrically discharged before touching the product with his/her hands or tools. This is most easily done by touching a metal part of the system chassis.*
- ▶ *Do not handle this product out of its protective enclosure while it is not used for operational purposes unless it is otherwise protected.*
- ▶ *Prior any installation work ensure that there are no live wires on the installation site*
- ▶ *Do not handle the device if there is any damage visible.*
- ▶ *Do not operate the KBox C-103-NGSF with foreign objects inside the chassis.*
- ▶ *Further do not insert any retrieval device into the device while it is connected to power.*
- ▶ *Kontron rejects all liability for any and all damages resulting from operation of the unit with foreign objects inside the chassis.*
- ▶ *The KBox C-103-NGSF has to be installed and operated only by trained and qualified personnel.*
- ▶ *The KBox C-103-NGSF system is designed for usage within control cabinets only.*
- ▶ *Only personnel with appropriate qualifications, trainings and authorization are permitted to install and work with the Kontron KBox C-103-NGSF.*
- ▶ *This device shall only be installed in or connected to systems that fulfill all necessary technical and specific environmental requirements.*
- ▶ *The KBox C-103-NGSF system is designed to be operated in vertical position with attached mounting brackets as shown in Figure 4 and Figure 5. It is not allowed to install the KBox C-103-NGSF as a stand-alone (desktop) device.*
- ▶ *Do not remove the wall mounting brackets.*
- ▶ *The unit must be placed such that there is sufficient space in front of it for connecting the cables to the I/O interface connectors and for operating the power button.*
- ▶ *Leave sufficient free space around the unit to prevent the device from possibly overheating!*
- ▶ *To ensure proper operation, we recommended free space as specified below:*
  - ▶ *above and below: 100 mm (3.937")*
  - ▶ *left and right: 50 mm (1.96").*
- ▶ *It must be observed that all ventilation openings are not covered/obstructed by objects.*
- ▶ *The KBox C-103-NGSF must be firmly attached to a clean flat and solid mounting surface. Use proper fastening materials suitable for the mounting surface. Ensure that the mounting surface type and the used mounting solution safely support the load of the KBox C-103-NGSF and the attached components.*
- ▶ *Please follow the local/national regulations for grounding.*
- ▶ *The voltage feeds must not be overloaded. Adjust the cabling and the overcurrent protection to correspond with the electrical figures indicated on the type label.*
- ▶ *The type label is located on the right side of the system.*
- ▶ *It is recommended that the last cable attached to the system should be the power cable! Refer to the section 7.3 "DC Power Plug Terminal" and chapter 8/ "Starting Up".*
- ▶ *The unit is to be connected only to internal Ethernet networks without exiting a facility and being subjected to TNVs.*
- ▶ *External circuits connected to the device shall be SELV/PELV (galvanic separated from mains by double or reinforce insulation).*

- ▶ *Use copper conductors only if the field wiring terminal is only for connection to copper wire.*
- ▶ *Minimum temperature rating of the cables connected to the field wiring terminals is 77° C.*

## 7.1. Specifications of the internal M.2 Connectors

Table 7: Specifications of the internal M.2 Connectors

M.2 Connector No.	J13	J17 (non-functional)	J18
M.2 Connector type	B-Type	M-Type	B-Type
PCIe lanes/ Gen	X1 / G3		no
SATA	no		yes <sup>1</sup>
USB	2.0		2.0
MicroSIM	yes		no
Mech. Format			
2230	yes		no
3030	yes		no
2242	yes		yes
3042	yes		no <sup>2</sup>
2260	no		yes
2280	no		yes

yes<sup>1</sup>: muxed with SATA0/J24

no<sup>2</sup>: possible

## 7.2. Control Cabinet Mounting



Expansion card installation should be performed before installing the KBox C-103-NGSF into the control cabinet.

### **CAUTION**

Please observe the "General Safety Instructions for IT Equipment" (included) and the installation instructions (refer to the chapters 1/ and 7/).

Your KBox C-103-NGSF is supplied with assembled mounting brackets. The key holes of the upper and lower mounting brackets (Figure 21, pos. 1 and pos. 3) allow you to mount the KBox C-103-NGSF to a mounting side of the control cabinet in vertical position. This is the only permitted operating position.



For a sufficient air circulation around the device, we recommend not to place (mount) or operate any other devices within the "keep out area". The clearances of "50mm" and "100mm" around the KBox C-103-NGSF must be observed.

Figure 29: Keep out area for mounting around  
 KBox C-103-NGSF (front side view without fan tray)

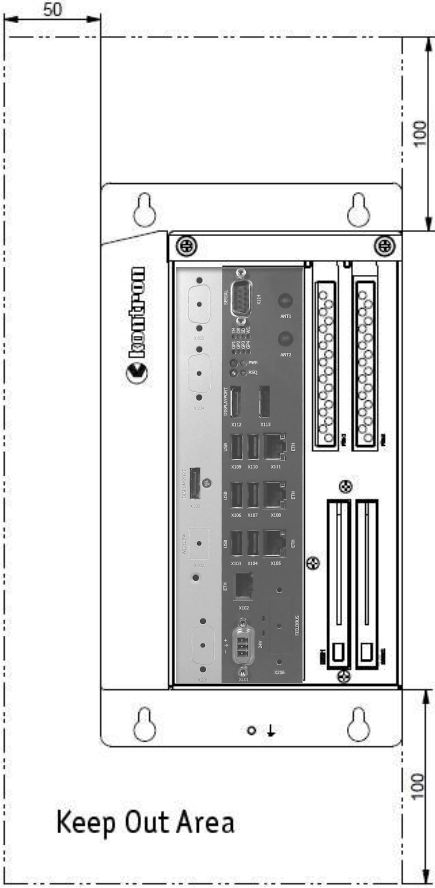
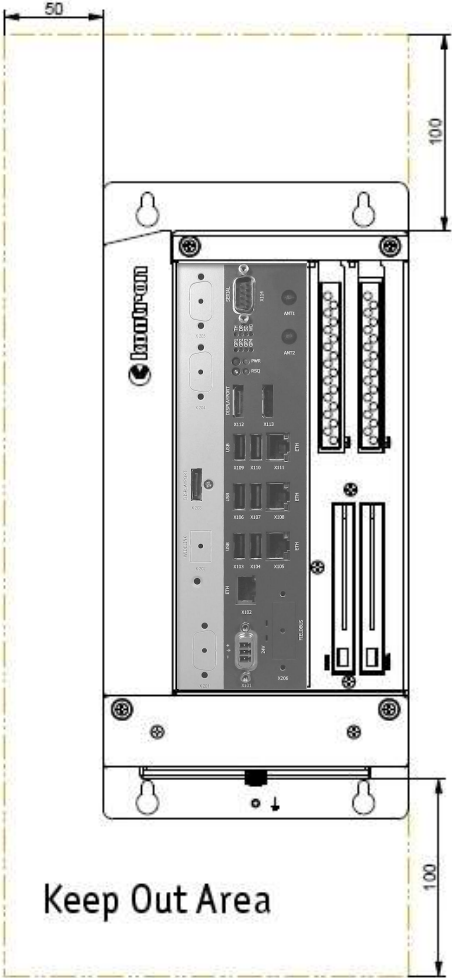


Figure 30: Keep out area for mounting around  
 KBox C-103-NGSF (front side view with optional fan tray)

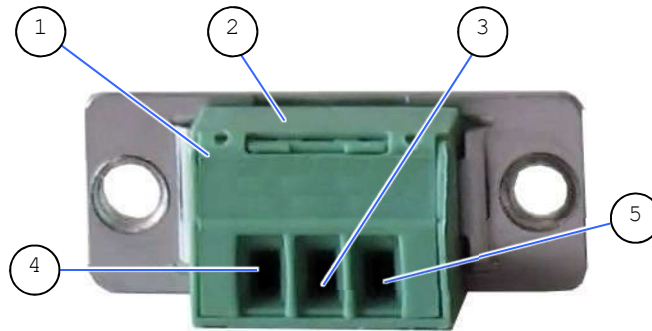


### 7.3. DC Power Plug Terminal

The KBox C-103-NGSF is connected by a Phoenix connector to a DC power source via a DC power supply wiring (only the Phoenix power plug terminal is included).

The KBox C-103-NGSF is delivered with a DC power plug terminal (3-pin Phoenix connector). For DC connection, prepare the connecting wires using the supplied Phoenix plug terminal: PSC 1,5/ 3-F.

Figure 31: Phoenix power plug terminal



- |   |  |   |                                       |
|---|--|---|---------------------------------------|
| 1 | 3-pin Phoenix plug terminal                      | 4 | Location for inserting the "24V" wire |
| 2 | Cover over the slotted pan head screws           | 5 | Location for inserting the "0V" wire  |
| 3 | Location for inserting the functional earth wire |   |                                       |

#### 7.3.1. Cabling

For the pin assignment Phoenix power plug terminal refer to the subsection 3.3.1 "X101/X201 - Power Input Connectors".

1. Cut the required length three isolated wires (1 mm<sup>2</sup>) AWG18 and strip each end 5 -7 mm.
2. Twist the striped wire-ends and provide them with ferrules.
3. Open the cover (Figure 31, pos. 2) to have access to the slotted pan head screws.
4. Loosen the slotted pan head screws of the DC plug terminal far enough so that you can insert the end of the prepared wires.
5. Insert the wires into the corresponding clamp of the Phoenix plug terminal. Make sure that you have the right polarity of the connection [refer to Figure 31, Figure 11 or subsection 12.1.1, "(X101) Power Input Connector "].
6. Fasten the screws to secure the wires into the clamps of the plug terminal.
7. Close the cover (Figure 31, pos. 2).



## 7.4. Side Wall Mounting (Option)

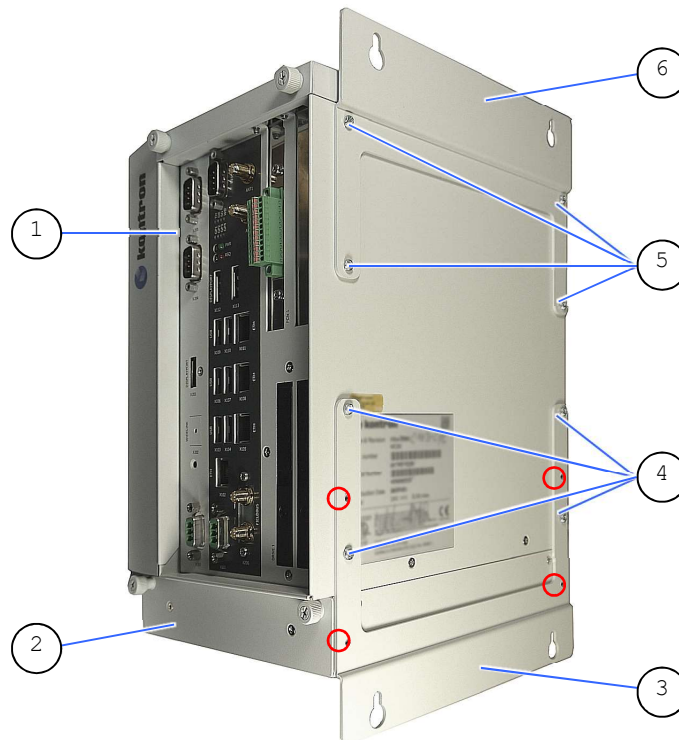
Your KBox C-103-NGSF can be mounted with optionally available side wall mounting brackets. The key holes of the upper and lower mounting brackets (Figure 32, pos. 3 and pos. 6) allow you to mount the KBox C-103-NGSF to a mounting side of the control cabinet in vertical position. This is the only permitted operating position. The lower side wall mounting bracket has different holes for mounting with and without fan tray (Figure 32, pos. 3 and pos. 4).



For a sufficient air circulation around the device, we recommend not to place (mount) or operate any other devices within the "keep out area". The clearances of "50mm" and "100mm" around the KBox C-103-NGSF must be observed.

Prepare the mounting surface with four screws and if necessary anchors corresponding to the mounting surface type (fire-resistant material).

Figure 32: KBox C-103-NGSF with fan tray and side wall mounting brackets



- |   |  |
|---|--|
| <p>1 KBox C-103-NGSF</p> <p>2 Fan tray (optional)</p> <p>3 Lower side wall mounting bracket with key holes, mounted in the "with fan tray" position.</p> <p><b>Red circles:</b> Mounting holes for the lower side wall mounting bracket if no fan tray is present</p> | <p>4 Mounting screws of the lower side wall mounting bracket, using the holes for mounting with fan tray present</p> <p>5 Mounting screws of the upper side wall mounting bracket</p> <p>6 Upper side wall mounting bracket with key holes</p> |
|---|--|

## 8/ Starting Up




---

The KBox C-103-NGSF must be operated only with the nominal voltage of 24V DC of type SELV. For details refer to the chapter 11/ "Technical Specifications".

---

### 8.1. Connecting to DC Main Power Supply

The DC input connector (Figure 9 and Figure 11 marked X101) is located on the front side of the KBox C-103-NGSF. The

KBox C-103-NGSF will be connected to a DC main power supply via the supplied Phoenix power plug terminal (see Figure 31) and corresponding power wires (prepared as described in the subsection 7.3.1 "Cabling").

#### **NOTICE**

Before using your system, become familiar with the system components and check that everything is properly connected. Following a proper cabling procedure will prevent a false power-on condition, which could result in unit operational failure.

When you install/disconnect the unit, the functional earth connection must always be made first and disconnected last.

Also, it is recommended that the last connections attached to the system should be the power wires!

---

#### **CAUTION**

The KBox C-103-NGSF must be connected to a DC mains power supply complying with the requirements of IEC 61010-1 and IEC 60950-1 standard or better. It must be observed that wiring and short-circuit/overcurrent protection is performed according to the applicable standards, regulations and respect to the electrical specification of the KBox C-103-NGSF.

Even when the system is turned off via the power button (Figure 9 and Figure 12, marked PWR) parts of the system are still energized.

The disconnecting device (fuse/circuit breaker) rating must be in accordance with the wire cross-section and the rated current of the KBox C-103-NGSF.

---

The wires used for power connections must be clearly marked (+/- /functional earth) to ensure that they will be properly connected to the DC IN connector of the KBox C-103-NGSF and to the main power source, corresponding to signals marked; refer to Figure 11 and Figure 31.

In addition, the cables must have some form of support so as to minimize the strain on the unit's connectors.

---

#### **NOTICE**

Only connect to an external power supply delivering the specified input rating and complying with the requirements of Safety Extra Low Voltage (SELV) and Limited Power Source (L.P.S.) of UL/IEC 60950-1 or (PS2) of UL/IEC 62368-1.

---

To connect the KBox C-103-NGSF to a corresponding DC main power supply, please perform the following steps:

1. Ensure that the DC power source is switched off via a disconnecting device (circuit breaker), in order to ensure that no power is flowing from the external DC power source during the connection procedure.
2. Connect at first the wire for "Functional Earth stud" (Figure 21, pos. 6) to an appropriate "common earth" connection point.
3. Connect the Phoenix power terminal prepared as described in the subsection 7.3.1 "Cabling" to the DC input connector (Figure 9 and Figure 11 marked X101) of the KBox C-103-NGSF. The DC input connector is located on the front side and is marked "24VDC".
4. Connect the other ends of the DC power wires to the connections of the DC main power supply. Pay attention to the polarity of the connections.
5. Switch on the disconnecting device (circuit breaker) in order to apply voltage to the terminals of the power wires.

## 8.2. Power OFF/ON Procedure

As the KBox C-103-NGSF is equipped with an internal hold-up buffer, it can't be powered off/on immediately.

The buffer time depends on the power consumption and load on the KBox C-103-NGSF processor and peripherals. Therefore the following procedure must be observed.

1. Close your applications and perform an orderly shutdown (graceful shutdown).
2. Remove power from the system.
3. Wait until the green power LED (Figure 12, pos. 2) stops blinking.
4. Reapply power.

Refer also to the subsection 3.3.7 "POWER Button and PWR LED".

### NOTICE

---

Do not disconnect the power from your system while it is powered up! Performing a forced shutdown can lead to loss of data or other undesirable effects!

---

## 8.3. Operating System and Hardware Component Drivers

Your system can be supplied optionally with a pre-installed operating system.

If you have ordered your KBox C-103-NGSF with a pre-installed operating system, all drivers are installed in accordance with the system configuration ordered (optional hardware components). Your system is fully operational when you power it on for the first time.

If you have ordered The KBox C-103-NGSF without a pre-installed operating system, you will need to install the operating system and the appropriate drivers for the system configuration you have ordered (optional hardware components) yourself.




---

You can download the relevant drivers for the installed hardware from our web site at [www.kontron.com](http://www.kontron.com) by selecting the product. Pay attention to the manufacturer specifications of the operating system and the integrated hardware components.

---

## 9/ Maintenance and Cleaning

Equipment from Kontron requires only minimum servicing and maintenance for proper operation.

- ▶ *For light soiling, clean the KBox C-103-NGSF with a dry cloth. Carefully remove dust from the surface of the cooling fins of the chassis using a clean, soft brush.*
- ▶ *Stubborn dirt should be removed using a mild detergent and a soft cloth.*

### NOTICE

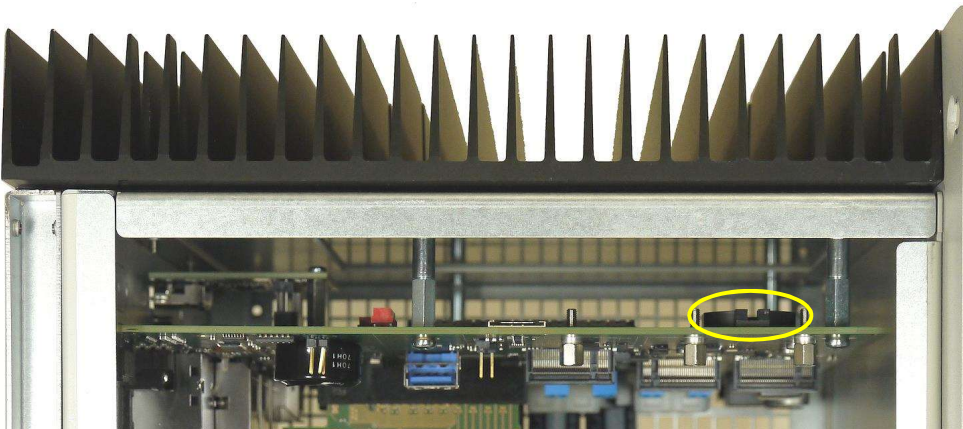
Do not use steel wool, metallic threads or solvents like abrasives, alcohol, acetone or benzene for cleaning the KBox C-103-NGSF.

### 9.1. Replacing the Lithium Battery

If your KBox C-103-NGSF is equipped with the optional lithium battery (CR 2032, 3V, internally accessible), and you have to replace it, please proceed as follows:

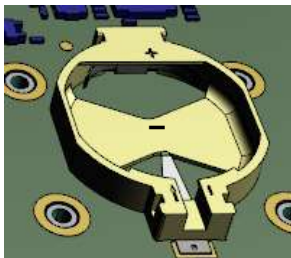
1. Open the topside access cover as describes in chapter 5.2 "Opening and Closing the KBox C-103-NGSF"
2. The battery is located on the side of the baseboard that faces to the cooling fins (see Figure 33).

Figure 33: Location of the optional Lithium battery



3. Remove the lithium battery from the holder by pulling it outwards.
4. Place a new lithium battery in the battery holder.
5. Pay attention to the polarity of the battery: the plus pole must face to the top side, the minus pole to the bottom side of the battery holder (see Figure 34).

Figure 34: Lithium battery polarity



6. The lithium battery must only be replaced with the same type of battery or with a type of battery recommended by Kontron Europe.

7. Close the top access cover.

### CAUTION

Danger of explosion when replacing with wrong type of battery. Replace only with the same or equivalent type recommended by the manufacturer. The lithium battery type must be UL recognised.



Do not dispose of lithium batteries in general trash collection. Dispose of the battery according to the local regulations dealing with the disposal of these special materials, (e.g. to the collecting points for dispose of batteries).

## 9.2. Preventive Maintenance for SSD Drives

This section applies to all M.2 and SSD devices installed into the KBox C-103-NGSF system.



Because of the limited predetermined lifespan of the M.2/SATA SSD devices, we recommend to check the condition of your installed SSD drives via S.M.A.R.T. regularly.  
Pay attention to the manufacturer specifications for lifespan.

For replacing of these devices refer to the sections: 3.3.11 and 5.2.4.

## 9.3. Replacing the Fan Tray

### NOTICE

The operation of the KBox C-103-NGSF versions with fan tray extension is permitted only with a functional fan tray!

Defective components may only be replaced by Kontron original spare parts:

▶ *Part number of the fan tray: 9-5000-1095 for KBox C-103-NGSF*

The fan tray can be replaced during operation. This should only be carried-out by qualified personnel aware of the associated dangers.

The fan will not stop immediately when the fan tray is removed during operation. Pull out the fan tray only a few centimeters and wait until the fan comes to stop.

To replace fan tray, proceed as follows:

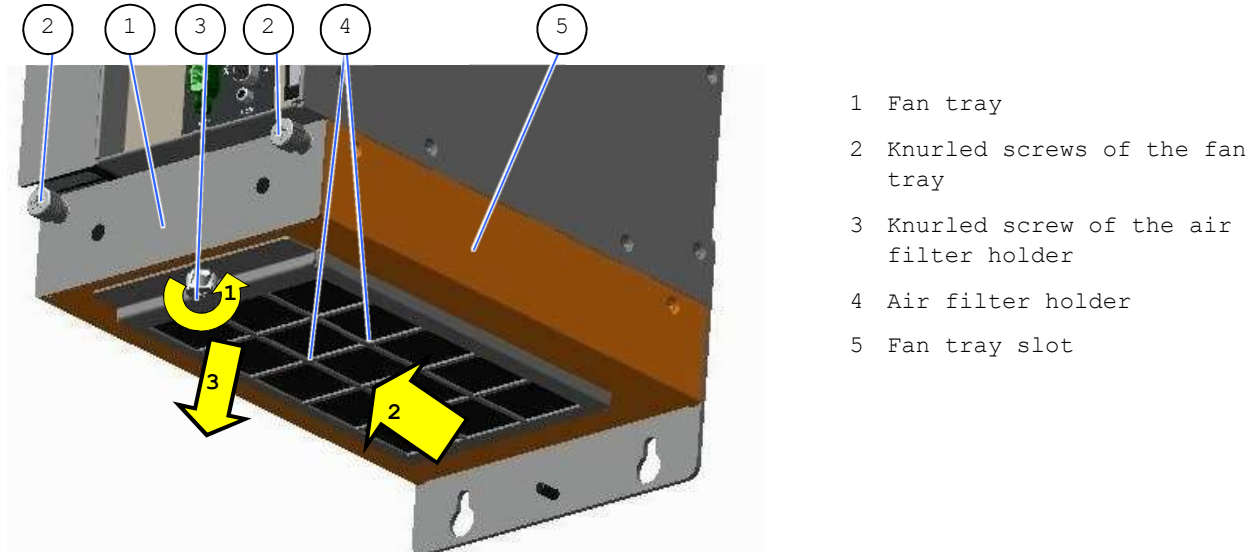
1. Ensure to have access to the bottom side of the KBox C-103-NGSF. The fan tray (Figure 35, pos. 1 and Figure 36, pos. 2) may be replaced without removing the air filter holder (Figure 35, pos. 4).
2. Loosen the two knurled screws (Figure 35, pos. 2) of the fan tray.
3. Pull the fan tray (Figure 36, pos. 2) out from the fan tray slot (Figure 36, pos. 3) in order to disconnect the connector for fan power and control from the internal fan control socket (Figure 36, pos. 10).
4. Pull the fan tray completely out from the fan tray slot (Figure 36, pos. 3).
5. Replace the defective fan tray with a new one.
6. Insert the functional fan tray (Figure 36, pos. 2) into the fan tray slot (Figure 36, pos. 3).

7. Secure the fan tray by fastening the knurled screws (Figure 35, pos. 2). By fastening of the knurled screws the proper insertion of the fan tray into the internal socket (Figure 36, pos. 10) is ensured.

## 9.4. Cleaning the Air Filter

The air filter is inserted in the holder (Figure 22, pos. 2) at the bottom side of the fan tray slot (Figure 22, pos. 6). The soiling of the air filter (Figure 22, pos. 3) is caused by the pollution of the operating environment. A heavily soiled air filter can cause excessive heating of the device. For this reason we recommend to clean the air filter as often as necessary. The air filter can be changed during operation of the system.

Figure 35: Fan tray extension (detail: shown as KBox C-103-NGSF-1)



To replace the air filter, proceed as follows:

1. Ensure to have access to the bottom side of the KBox C-103-NGSF. The air filter may be replaced without removing the fan tray (Figure 35, pos. 1).
2. Loosen the knurled screw (Figure 35, pos. 3) that secures the air filter holder (Figure 35, pos. 4) to the fan tray slot (Figure 35, pos. 5); refer to step 1 in Figure 35.
3. Pull the air filter holder out of the positioning holes, (Figure 36, pos. 9) into the marked direction (see Figure 35) and pull it down. Put the air filter holder aside for later reassembly; refer to step 2 and 3 in Figure 35.
4. Remove the soiled air filter (Figure 35, pos. 3 and Figure 36, pos. 6).
5. Clean the air filter as follows:
6. Rinse in water (up to approx. 40°C; possibly with the addition of a standard mild detergent).
7. It is possible to clean the air filter with compressed air.
8. For dirt that contains grease/oil, the air filter should be rinsed with warm water with the addition of a degreaser. Air filter should not be cleaned with powerful water jets or wrung out.
9. After cleaning and drying the air filter, place it in the air filter holder.
10. Reattach the air filter holder to the bottom side of the fan tray slot by inserting the positioning latches (Figure 36, pos. 8) into the positioning holes (Figure 36, pos. 9).
11. Secure the air filter holder by tightening the knurled screw to the tapped hole (Figure 36, pos. 4) of the fan tray slot (Figure 35, pos. 5 or Figure 36, pos. 3).

**NOTICE**

Defective components may only be replaced by Kontron original spare parts.

▶ Air filter: part number: 9-5000-1098 (for KBox C-103-NGSF)

Figure 36: KBox C-103-NGSF with removed fan tray and removed air filter

Figure 37: Filter mat Holder without air filter

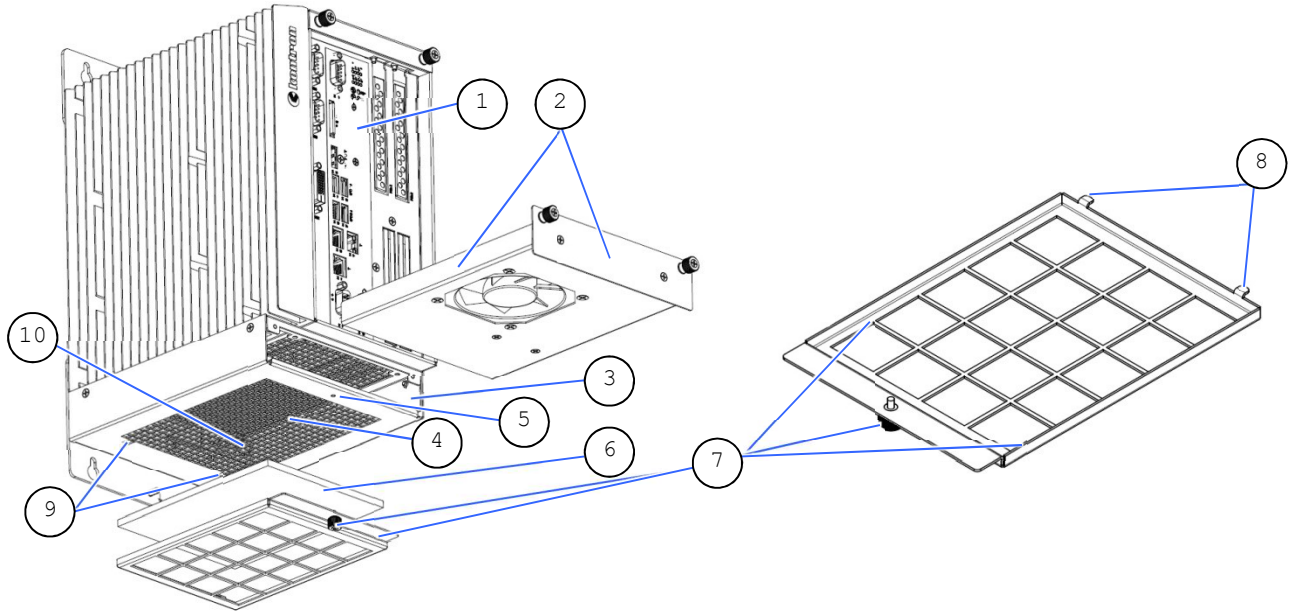
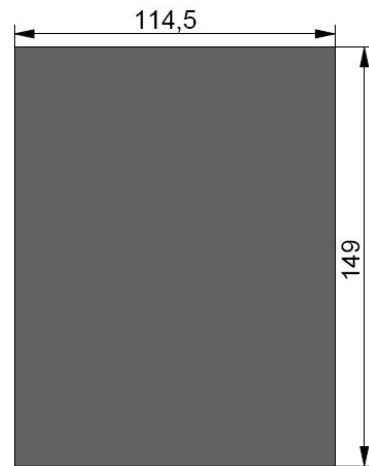
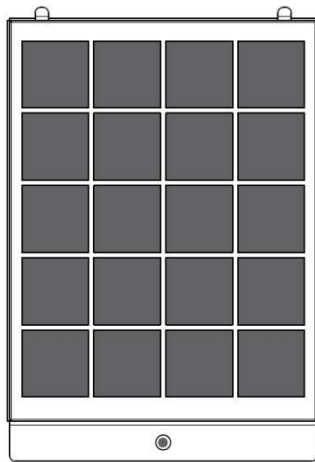


Figure 38: Holder (shown for KBox C-103-NGSF) with air filter

Figure 39: Air filter (shown for KBox C-103-NGSF)





- 1 KBox C-103-NGSF assembled with the optional fan tray slot
- 2 Removed fan tray
- 3 Fan tray slot without inserted fan tray
- 4 Air intake openings at the bottom side of the fan tray slot
- 5 Tapped hole to secure the knurled screw of the air filter holder
- 6 Removed air filter
- 7 Air filter holder with knurled screw
- 8 Positioning latches of the air filter holder
- 9 Positioning holes for the air filter holder
- 10 Socket for fan power and control (on internal rear side of the fan tray slot)

## 10/ uEFI BIOS

### 10.1. Starting the uEFI BIOS

The KBox C-103-NGSF-x is provided with a Kontron-customized, pre-installed and configured version of AMI Aptio ® V uEFI BIOS based on the Unified Extensible Firmware Interface (uEFI) specification and the Intel® Platform Innovation Framework for EFI. This uEFI BIOS provides a variety of new and enhanced functions specifically tailored to the hardware features of the KBox C-103-NGSF-x.




---

The BIOS version covered in this document might not be the latest version. The latest version might have certain differences to the BIOS options and features described in this chapter.

---




---

Register for the EMD Customer Section to get access to BIOS downloads and PCN service.

---

The uEFI BIOS comes with a Setup program that provides quick and easy access to the individual function settings for control or modification of the uEFI BIOS configuration. The Setup program allows for access to various menus that provide functions or access to sub-menus with further specific functions of their own.

To start the uEFI BIOS Setup program, follow the steps below:

1. Power on the board.
2. Wait until the first characters appear on the screen (POST messages or splash screen).
3. Press the <DEL> key.
4. If the uEFI BIOS is password-protected, a request for password will appear. Enter either the User Password or the Supervisor Password, press <RETURN>, and proceed with step 5.
5. A Setup menu appears.

The KBox C-103-NGSF-x uEFI BIOS Setup program uses a hot key navigation system. The hot key legend bar is located at the bottom of the Setup screens. The following table provides a list of navigation hot keys available in the legend bar.

Table 8: Navigation Hot Keys Available in the Legend Bar

Sub-screen	Description
<F1>	<F1> key invokes the General Help window
<->	<Minus> key selects the next lower value within a field
<+>	<Plus> key selects the next higher value within a field
<F2>	<F2> key loads previous values
<F3>	<F3> key loads optimized defaults
<F4>	<F4> key Saves and Exits
<-> or <↔>	<Left/Right> arrows selects major Setup menus on menu bar, for example, Main or Advanced
<↑> or <↓>	<Up/Down> arrows select fields in the current menu, for example, Setup function or sub-screen
<ESC>	<ESC> key exits a major Setup menu and enters the Exit Setup menu Pressing the <ESC> key in a sub-menu displays the next higher menu level

<RETURN>	<RETURN> key executes a command or selects a submenu
----------	--

## 10.2. Setup Menus

The Setup utility features menus listed in the selection bar at the top of the screen:

- ▶ *Main*
- ▶ *Advanced*
- ▶ *Chipset*
- ▶ *Security*
- ▶ *Boot*
- ▶ *Save & Exit*

The left and right arrow keys select the Setup menus. The currently active menu and the currently active uEFI BIOS Setup item are highlighted in white.

Each Setup menu provides two main frames. The left frame displays all available functions. Configurable functions are displayed in blue. Functions displayed in grey provide information about the status or the operational configuration. The right frame displays an Item Specific Help window providing an explanation of the respective function.

### 10.2.1. Main Setup Menu

On entering the uEFI BIOS the Setup program displays the Main Setup menu. This screen lists the Main Setup menu sub-screens and provides basic system information as well as functions for setting the system language, time and date.

Table 9: Main Setup Menu Sub-screens and Functions

Sub-screen	Description
BIOS Information	Read only field Displays information about the BIOS system Vendor, Core version, Compliancy, Kontron BIOS Version, and Access level
Board Information	Read only field Board ID, Fab ID, LAN PHY Revision
Processor Information	Read only field Displays information about the CPU Name, Type, Speed, Processor ID, Stepping, Package, Number of Processors, Microcode Version, GT Info and eDRAM size,
(Memory Information)	Read only field Displays information about eDRAM Size, IGFX VBIOS/IGFX GOP/Memory RC Version, Total Memory and Memory Frequency
PCH Information	Read only field Displays information about the PCH Name, PCH SKU, Stepping, ChipsetInit Base/ChipsetInit OEM Revision, Package, TXT Capability of Platform/PCH, Production Type, ME FW Version and ME Firmware SKU
ME FW	Read only field ME Firmware Version, ME Firmware Consumer SKU
System language	Selects system language
Platform Information	Read only subscreen Module Information: Displays information about Product Name, Revision Serial #, MAC Adress, Boot Counter and CPLD Revision
System Date	Displays System Date
System Time	Displays System Time

### 10.2.2. Advanced Setup Menu

The Advanced Setup menu provides sub-screens and second level sub-screens with functions, for advanced configuration and Kontron specific configurations.

#### NOTICE

Setting items, on this screen, to incorrect values may cause system malfunctions.

### 10.2.3. Chipset Setup Menu

On entering the Chipset Setup menu, the screen lists two sub-screen options:

- ▶ *System Agent*
- ▶ *PCH-IO*

Entering the System Agent Configuration and PCH-IO Configuration sub-screens provides basic system information and possible functions for these configurations.

### 10.2.4. Security Setup Menu

The Security Setup menu provides information about the passwords and functions for specifying the security settings. The passwords are case-sensitive.

Table 10: Security Setup Menu Functions

Function	Description
Administrator Password	Sets administrator password
User Password	Sets user password



If only the administrator's password is set, then only access to setup is limited. The password is only entered when entering setup.

If only the user's password is set, then the password is a power on password and must be entered to boot or enter setup. Within the setup menu the user has administrator rights.

Password length requirements are maximum length 20 and minimum length 3.

#### 10.2.4.1. Remember the Password

It is highly recommended to keep a record of all passwords in a safe place. Forgotten passwords results in the user being locked out of the system.

If the system cannot be booted because the User Password or the Supervisor Password are not known, see Chapter 10.5 "Updating the uEFI BIOS" for information about clearing the uEFI BIOS settings, or contact Kontron Support for further assistance.




---

HDD security passwords cannot be cleared using the above method.

---

### 10.2.5. Boot Setup Menu

The Boot Setup menu lists dynamically generated boot device priority order.

### 10.2.6. Save and Exit Setup Menu

The Save and Exit Setup menu provides functions for handling changes made to the uEFI BIOS settings and exiting of the Setup program.

Table 11: Save and Exit Setup Menu Functions

Function	Description
Save Changes and Exit>	Exits system after saving changes
Discard Changes and Exit>	Exits system setup without saving any changes
Save Changes and Reset>	Resets system after saving changes
Discard Changes and Reset>	Resets system setup without saving any changes
Save Changes>	Saves changes made so far for any of the setup options
Discard Changes>	Discards changes made so far for any setup options
Restore Defaults>	Restores/loads standard default values for all setup options
Save as User Defaults>	Saves changes made so far as user defaults
Restore User Defaults>	Restores user defaults to all setup options
UEFI: Built-in EFI shell>	Attempts to launch the built in EFI Shell

## 10.3. The uEFI Shell

The Kontron uEFI BIOS features a built-in and enhanced version of the uEFI Shell. For a detailed description of the available standard shell scripting, refer to the EFI Shell User Guide. For a detailed description of the available standard shell commands, refer to the EFI Shell Command Manual. Both documents can be downloaded from the EFI and Framework Open Source Community homepage (<http://sourceforge.net/projects/efi-shell/files/documents/>).




---

Kontron uEFI BIOS does not provide all shell commands described in the EFI Shell Command Manual.

---

### 10.3.1. Basic Operation of the uEFI Shell

The uEFI Shell forms an entry into the uEFI boot order and is the first boot option by default.

### 10.3.1.1. Entering the uEFI Shell

To enter the uEFI Shell, follow the steps below:

1. Power on the board.
2. Press the <F7> key (instead of <DEL>) to display a choice of boot devices.
3. Choose 'UEFI: Built-in EFI shell'.

```

UEFI Interactive Shell v2.2
EDKII / Kontron add-on v0.1
UEFI v2.70 (American Megatrends, 0x0005000D)
Mapping table:
  FS0:   Alias(s):HD0f0b;BLK1:
         PciRoot(0x0)/Pci(0x14,0x0)/USB(0x5,0x0)/HD(1,MBR,0x0008131B,0x1,0x6C7ff)
  BLK0:  Alias(s):
         PciRoot(0x0)/Pci(0x14,0x0)/USB(0x5,0x0)

```

4. Press the ESC key within 5 seconds to skip startup.nsh, and any other key to continue.
5. The output produced by the device-mapping table can vary depending on the board's configuration.
6. If the ESC key is pressed before the 5 second timeout elapses, the shell prompt is shown:

```
Shell>
```

### 10.3.1.2. Exiting the uEFI Shell

To exit the uEFI Shell, follow one of the steps below:

1. Use the **exit** uEFI Shell command to select the boot device, in the Boot menu, for the OS to boot from.
2. Reset the board using the reset uEFI Shell command.

## 10.4. uEFI Shell Scripting

### 10.4.1. Startup Scripting

If the ESC key is not pressed and the timeout has run out then the uEFI Shell tries to execute some startup scripts automatically. It searches for scripts and executes them in the following order:

1. Initially searches for Kontron flash-stored startup script.
2. If there is no Kontron flash-stored startup script present then the uEFI-specified `startup.nsh` script is used. This script must be located on the root of any of the attached FAT formatted disk drive.
3. If none of the startup scripts are present or the startup script terminates then the default boot order is continued.

### 10.4.2. Create a Startup Script

Startup scripts can be created using the uEFI Shell built-in editor **edit** or under any OS with a plain text editor of your choice. To create a startup shell script, simply save the script on the root of any FAT-formatted drive attached to the system. To copy the startup script to the flash, use the **kBootScript** uEFI Shell command.

In case there is no mass storage device attached, the startup script can be generated in a RAM disk and stored in the SPI boot flash using the **kRamdisk** uEFI Shell command.

### 10.4.3. Examples of Startup Scripts

#### 10.4.3.1. Execute Shell Script on Other Harddrive

This example (**startup.nsh**) executes the shell script named **bootme.nsh** located in the root of the first detected disc drive (**fs0**).

```
fs0:  
bootme.nsh
```



## 10.5. Updating the uEFI BIOS

The KBox C-103-NGSF has one standard SPI boot flash.

### 10.5.1. Updating Procedure

For the BIOS update the customer should follow the instructions in the Readme.txt BIOS package.

### 10.5.2. uEFI BIOS Recovery

In case of the standard SPI boot flash being corrupted the KBOX C-103-NGSF must be returned to Kontron to repair the system. There is no recovery flash available.

## 11/ Technical Specifications

Table 12: Technical Specifications

KBox C-103-NGSF Family				
Installed COM Express Module and Baseboard	Baseboard with COMe-cTL6 (see Device passport)			
BIOS	AMI Aptio V uEFI			
Controls (at the front side)	Power button (PWR)			
Interfaces (front side accessible)	1x Ethernet (10/100/1000 Mbit/s) x Ethernet (10/100/1000 Mbit/s) 3x USB 3.0 3x USB 2.0 2x DisplayPort 1x Serial port (RS232/RS422/RS485)			
DC IN Connector (at the front side)	3-pin DC input connector			
Protection Class	IP20			
Lithium Battery (Option) (internally accessible)	CR 2032, 3 V			
Rated Voltage (tolerance)	24 VDC/6 A (+20%/-20%), up to 20ms hold-up (depending on configuration)			
		KBox C-103-NGSF		
Options for Storage Media		2x 2.5" SATA HDD/SSD non removable <b>or</b> 2x 2.5" removable SATA HDD/SSD for: Up to 2x M.2 1x MicroSD Card		
Free Expansions Sockets (internal)		2x M.2 B-type 1x full/half size Mini PCIe x1 1x PCIe x4		
Fan Tray (Option)		yes		

### 11.1.1. Mechanical Specifications of the KBox C-103-NGSF

Figure 40: Dimensions: right side (KBox C-103-NGSF)

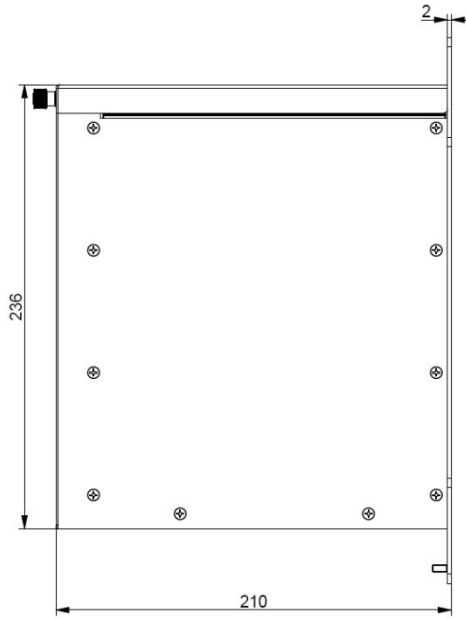


Figure 41: Dimensions: front side with key holes (KBox C-103-NGSF)

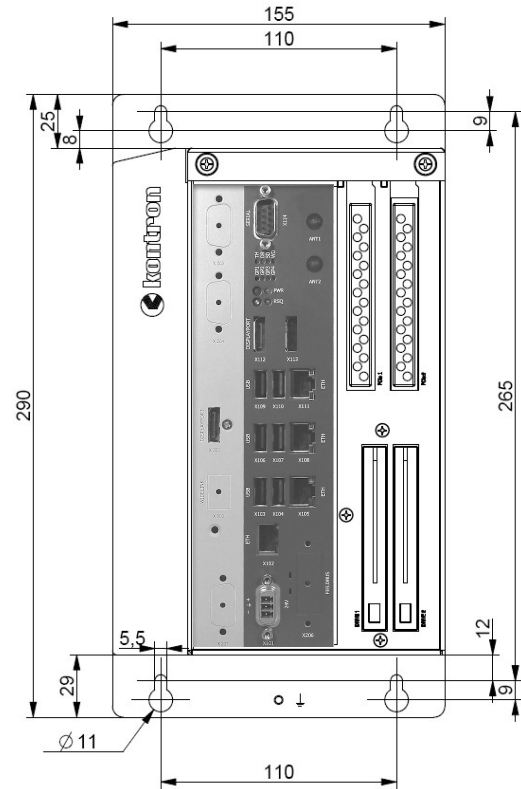


Figure 42: Dimensions: detail key hole (KBox C-103-NGSF)

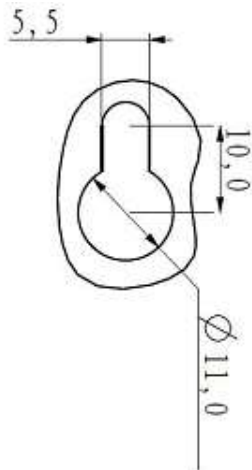
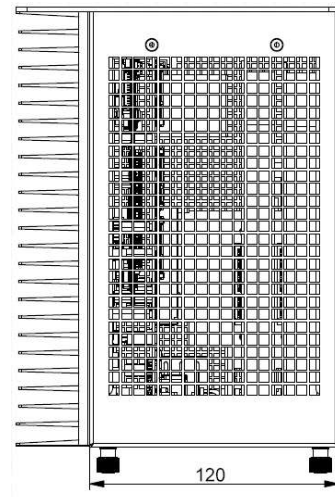


Figure 43: Dimensions: top side (KBox C-103-NGSF)



### 11.1.2. Mechanical Specifications of the KBox C-103-NGSF with Fan Tray Option

Figure 44: Dimensions: right side  
(KBox C-103-NGSF with fan tray option)

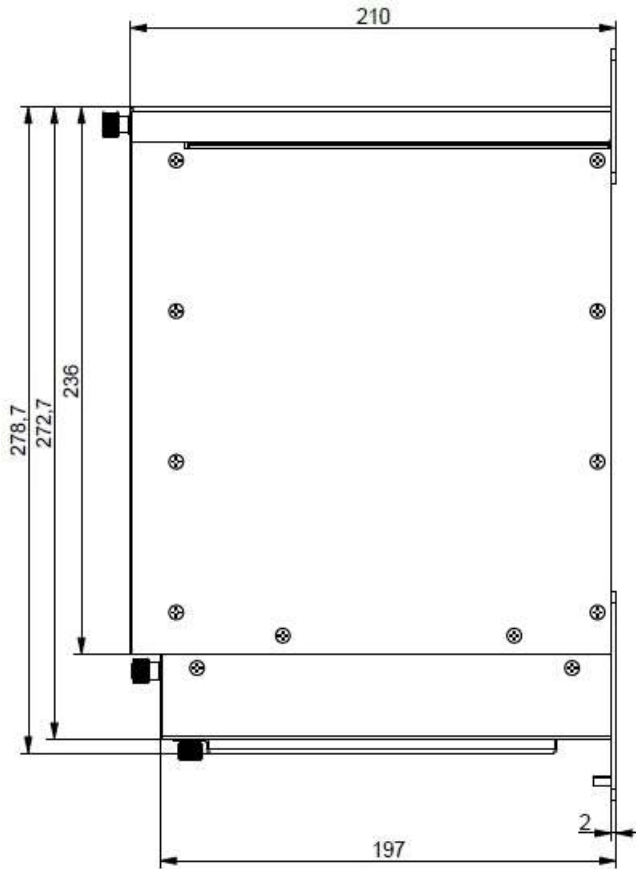


Figure 46: Dimensions: detail key hole  
(KBox C-103-NGSF with fan tray option)

Figure 45: Dimensions: front side with key holes  
(KBox C-103-NGSF with fan tray option)

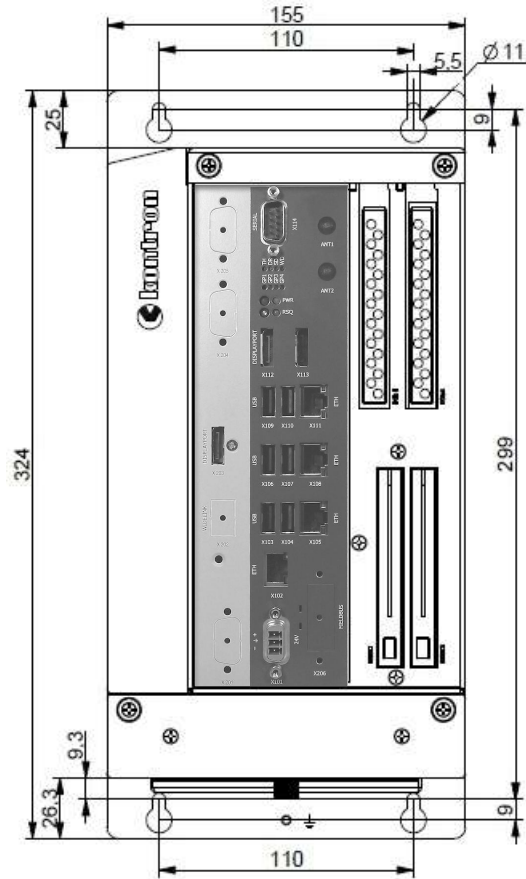


Figure 47: Dimensions: top side  
(KBox C-103-NGSF with fan tray option)

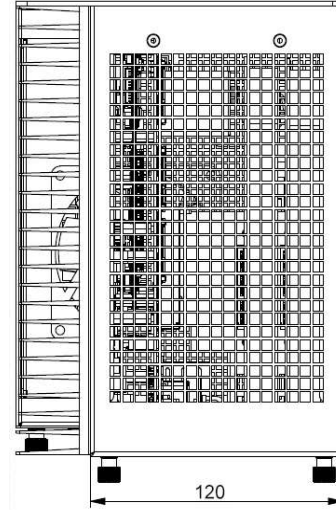
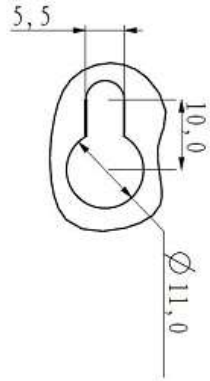


Table 13: Mechanical Specifications of the KBox C-103-NGSF

Dimensions	KBox C-103-NGSF (Standard Version)	KBox C-103-NGSF (with optional Fan Tray)
Height	with mounting brackets: 290 mm (11.42")	with mounting brackets: 324 mm (12.756")
Width	155 mm (6.10")	155 mm (6.10")
Depth	with mounting brackets: 210 mm (8.26")	with mounting brackets: 210 mm (8.26")
Weight (without packaging, without expansions)	Approx. 4.75 kg (10.47 lbs.)	Approx. 6.00 kg (13.22 lbs.)
Chassis	Cooling fins, black Chassis: steel sheet, light grey (RAL 7035) Side with External Interfaces : trim strips, traffic grey (RAL 7043)	

## 11.2. Environmental Specifications

Table 14: Environmental Specifications

	KBox C-103-NGSF
Thermal Management	Convection cooling/with fan
Operating Temperature (with Fan Tray)	0°C to +60°C (32°F to 140°F)
Operating Temperature (w/o Fan Tray)	0°C to +55°C (32°F to 131°F)
Storage / Transit Temperature	-40°C ... +75°C (-40°F ... +167°F)
Relative Humidity (Operating)	93 % @ 40 °C (non condensing) acc. to IEC 60068-2-78
Max. Operation Altitude	2,000 m (6,560 ft.)
Max. Storage / Transit Altitude	10,000 m (32,810 ft.)
Non-Operating Shock	30 G, 11 ms, half sine, acc. to IEC 60068-2-27
Operating Shock	15 G, 11 ms, half sine, acc. to IEC 60068-2-27
Non-Operating Vibration	10 Hz - 150 Hz, 2 G, acc. to IEC 60068-2-6
Operating Vibration	10 Hz - 150 Hz, 1 G, acc. to IEC 60068-2-6
Pollution Degree	2

## 11.3. Standards, Certifications and Directives Compliance

Because the KBOX C-103-NGSF is a Proof of Concept System, there are no certifications that can be assured.

## 11.4. Power Supply Specification

Before connecting the product to a mains power supply, ensure that the power supply meets the required electrical specification for the product and that protection and supply limitation have been taken into consideration. The power supply used must also automatically recover from AC power loss and start up under peak loading.

Connect the product only to a power supply designed to achieve NEC Class-2 and Limited Power Source (LPS).

Table 15: KBox C-103-NGSF-x Electrical Specification

Nominal Input Voltage	24 VDC
Input Voltage Range	17 VDC to 36 VDC
Input Current	6.0 A max.
Inrush Current	10 A max. ( at 17 VDC)
Power	140 W (max.)

### ⚠ CAUTION

Observed that wiring and short-circuit/overcurrent protection is performed according to the applicable standards, regulations and in respect to the product's electrical specification. The disconnecting device (fuse/circuit breaker) rating must be in accordance with the product's wire cross-section

### NOTICE

Only connect to an external power supply delivering the specified input rating and complying with the requirements of Safety Extra Low Voltage (SELV) and Limited Power Source (L.P.S.) of UL/IEC 60950-1 or (PS2) of UL/IEC 62368-1.

### NOTICE

Ensure that the power supply is used according to the manufacturer's instructions.

### NOTICE

Ensure the power supply has been fully tested to at least meet the minimum immunity of AC inputs requirements, as stipulated in IEC 55024. Including power supplies marketed with a separate AC/DC power converter.

### 11.4.1. Power Supply Protection Requirements

The used external power supply is required to incorporate protection and supply features such as over current protection, inrush current protection, over voltage protection and undervoltage (brownout) protection, to protect the product against fluctuations and interruptions in the delivered DC power supply.

### NOTICE

If an under voltage (brownout) condition occurs, the used power supply must remain in the "off state" long enough to allow internal voltages to discharge sufficiently. Failure to observe this "off state" may mean that parts of the product or peripherals work incorrectly or suffer a reduction of MTBF. The minimum "off state", to allow internal voltages to discharge sufficiently, is dependent on the power supply



and additional electrical factors. To determine the required "off state", each case must be considered individually. For more information, contact Kontron Support.

---

### 11.4.2. Power Consumption

The used external power supply must be capable of delivering the product with the required power when configured with all components. The total power consumption depends on factors such as the CPU, interfaces, and system/memory expansion.



---

The external power supply must supply power to all configured components.

---

### 11.4.3. Protective Earth Stud Bolt

The protective earth stud bolt connects to the internal chassis GND. The protective earth stud bolt is located at the bottom of the System.

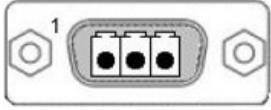
When installing cables to the product the first cable connection must be to the protective earth stud bolt and when disconnecting the last cable to be disconnected must be from the protective earth stud bolt

## 12/ Standard Interfaces - Pin Assignments

Low-active signals are indicated by a minus sign.

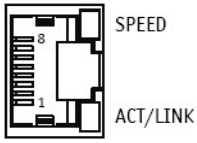
### 12.1.1. (X101) Power Input Connector

Table 16: (X101) Power Input Connector

Pin	Signal Name	3-pin POWER SUBCON (male)
1	+24 VDC (input)	
2	Ground	
3	0V (input)	

### 12.1.2. (X102, X105, X108, X111) Ethernet Connectors

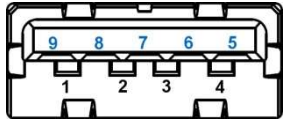
Table 17: (X102, X105, X108, X111) Ethernet Connectors

Pin	Signal Name	X102, X105, X108, X111 Ethernet (RJ45)
1	MDI0+	
2	MDI0-	
3	MDI1+	
4	MDI2+	
5	MDI2-	
6	MDI1-	
7	MDI3+	
8	MDI3-	

Speed (Mbps)		LINK/ACT	
		LINK	ACTIVE
10	off	on	orange on (blinking)
100	green	on	orange on (blinking)
1000	orange	on	orange on (blinking)

### 12.1.3. (X103, X106, X109) USB 3.0 Ports

Table 18: (X103, X106, X109) USB 3.0 Ports

Pin	Signal Name	Pin	Signal Name	9-pin USB Connector Type A Version 3.0/2.0
USB 2.0 contact pins		USB 3.0 contact pins		
1	VCC, fused (900 mA max.)	5	StdA_SSRX-	
2	Data-	6	StdA_SSRX+	
3	Data+	7	GND_DRAIN	
4	GND	8	StdA_SSTX-	
		9	StdA_SSTX+	

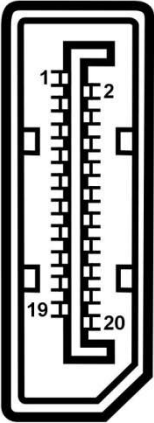
### 12.1.4. (X104, X107, X110) USB 2.0 Ports

Table 19: (X104, X107, X110) USB 2.0 Ports

Pin	Signal Name	4-pin USB Connector Typ A Version 2.0
1	VCC	
2	Data-	
3	Data+	
4	GND	

### 12.1.5. (X112, X113, X203) DisplayPorts

Table 20: (X112, X113, X203) DisplayPorts

Pin	Signal Name	DisplayPort	Signal Name	Pin
1	ML Lane 0 (p)		GND (ML Lane 0)	2
3	ML Lane 0 (n)		Lane 1 (p)	4
5	GND (ML Lane 1)		Lane 1 (n)	6
7	Lane 2 (p)		GND (ML Lane 2)	8
9	Lane 2 (n)		Lane 3 (p)	10
11	GND (ML Lane 3)		Lane 3 (n)	12
13	AUX SEL#		Pull-down to GND	14
15	AUX CH (p)		GND (AUX CH)	16
17	AUX CH (n)		Hot Plug	18
19	GND (GND_DDC)		3.3V (DDC EEPROM power 500 mA fused)	20

### 12.1.6. (X114) Serial Interface COM 1 (RS232, RS422, RS485)

The mode cannot be selected in the BIOS

Table 21: (X114) Serial Interface COM 1, configured as RS232)

Pin	Signal Name	9-pin D-SUB Connector (male)
1	DCD (Data Carrier Detect)	
2	RXD (Receive Data)	
3	TXD (Transmit Data)	
4	DTR (Data Terminal Ready)	
5	GND (Signal Ground)	
6	DSR (Data Set Ready)	
7	RTS (Request to Send)	
8	CTS (Clear to Send)	
9	RI (Ring Indicator)	

Table 22: (X114) Serial Interface COM 1, configured as single RS485

Pin	Signal Name	9-pin D-SUB Connector (male)
1	TxD/RxD- (Data -)	
2	TxD/RxD+ (Data+)	
3		
4		
5	GND (Signal Ground)	
6		
7		
8		
9		

Table 23: (X114) Serial Interface COM 1, configured as single RS422

Pin	Signal Name	9-pin D-SUB Connector (male)
1	TxD- (Transmit Data-)	
2	TxD+ (Transmit Data+)	
3	RxD+ (Receive Data+)	
4	RxD- (Receive Data-)	
5	GND (Signal Ground)	
6		
7		
8		
9		

Table 24: (X114) Serial Interface COM 1 and COM2, configured as dual RS485

Pin	Signal Name	9-pin D-SUB Connector (male)
1	TxD/RxD- (COM1 Data -)	
2	TxD/RxD+ (COM1 Data+)	
3		
4		
5	GND (Signal Ground)	
6	TxD/RxD- (COM2 Data -)	
7	TxD/RxD+ (COM2 Data+)	
8		
9		

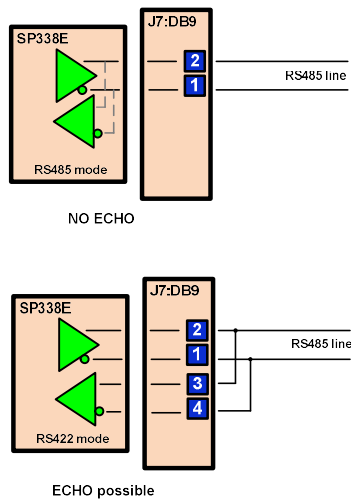
Table25: (X114) Serial Interface COM 1 and COM2, configured as dual RS422

Pin	Signal Name	9-pin D-SUB Connector (male)
1	TxD- (COM1 Transmit Data-)	
2	TxD+ (COM1 Transmit Data+)	
3	RxD+ (COM1 Receive Data+)	
4	RxD- (COM1 Receive Data-)	
5	GND (Signal Ground)	
6	TxD- (COM2 Transmit Data-)	
7	TxD+ (COM2 Transmit Data+)	
8	RxD+ (COM2 Receive Data+)	
9	RxD- (COM2 Receive Data-)	



If RS485 is needed in Echo mode, the RS422 mode must be selected and the lines must be connected according below picture.  
 If dual (RS422/RS485) mode is selected the second serial Port connector X205 is not usable.

Figure 48: RS485 Echo mode configuration



## 12.2. Optional Interfaces via Adapter Modules

### 12.2.1. (X201) 2<sup>nd</sup> Power Input Connector

For pin assignment, refer to 12.1.1.

### 12.2.2. (X 203) 3<sup>rd</sup> DisplayPort

For pin assignment, refer to 12.1.5.



---

This port must be factory installed and configured only.  
Your KBox C-103 can either be equipped with a 3<sup>rd</sup> DisplayPort or a WideLink port.  
Only one of these two interfaces (WideLink and DP 3) can be ordered as optional extension of your KBox C-103 system.

---

### 12.2.3. (X 205) Serial Port RS232/RS422



This port must be factory installed and configured only. When you order the KBox C-103 with this extended interface via RS232/422 adapter module, you have to specify in your ordering:

- ▶ the needed configuration of this port as RS232 or RS422 and
- ▶ for RS422 configuration: if the onboard termination resistor (120Ω) should be enabled or disabled.

#### 12.2.3.1. Serial Port RS232/RS422 configured as RS232

Table 26: Serial Port RS232/RS422 configured as RS232

Pin	Signal Name	9-pin D-SUB Connector (male)
1	DCD (Data Carrier Detect)	
2	RXD (Receive Data)	
3	TXD (Transmit Data)	
4	DTR (Data Terminal Ready)	
5	GND (Signal Ground)	
6	DSR (Data Set Ready)	
7	RTS (Request to Send)	
8	CTS (Clear to Send)	
9	RI (Ring Indicator)	

#### 12.2.3.2. Serial Port RS232/RS422 configured as RS422

Table 27: Serial Port RS232/RS422 configured as RS422

Pin	Signal Name	9-pin D-SUB Connector (male)
1	Do not connect	
2	RxD- (Receive Data-)	
3	TxD+ (Transmit Data+)	
4	Do not connect	
5	GND (Signal Ground)	
6	Do not connect	
7	TxD- (Transmit Data-)	
8	RxD+ (Receive Data+)	
9	Do not connect	







## About Kontron - Member of the S&T Group

Kontron is a global leader in IoT/Embedded Computing Technology (ECT). As a part of technology group S&T, Kontron, together with its sister company S&T Technologies, offers a combined portfolio of secure hardware, middleware and services for Internet of Things (IoT) and Industry 4.0 applications. With its standard products and tailor-made solutions based on highly reliable state-of-the-art embedded technologies, Kontron provides secure and innovative applications for a variety of industries. As a result, customers benefit from accelerated time-to-market, reduced total cost of ownership, product longevity and the best fully integrated applications overall.

For more information, please visit: [www.kontron.com](http://www.kontron.com)

---

▼

## GLOBAL HEADQUARTERS

### Kontron Europe GmbH

Gutenbergstraße 2  
85737 Ismaning, Germany  
Tel.: +49 821 4086-0  
Fax: +49 821 4086-111  
[info@kontron.com](mailto:info@kontron.com)