



KISS 2U Short V3

KISS 2U Short V3 CFL

Doc. User Guide, Rev. 1.2

Doc. ID: 1064-5121

This page has been intentionally left blank

 KISS 2U SHORT V3 - USER GUIDE

Disclaimer

Kontron would like to point out that the information contained in this user guide may be subject to alteration, particularly as a result of the constant upgrading of Kontron products. This document does not entail any guarantee on the part of Kontron with respect to technical processes described in the user guide or any product characteristics set out in the user guide. Kontron assumes no responsibility or liability for the use of the described product(s), conveys no license or title under any patent, copyright or mask work rights to these products and makes no representations or warranties that these products are free from patent, copyright or mask work right infringement unless otherwise specified. Applications that are described in this user guide are for illustration purposes only. Kontron makes no representation or warranty that such application will be suitable for the specified use without further testing or modification. Kontron expressly informs the user that this user guide only contains a general description of processes and instructions which may not be applicable in every individual case. In cases of doubt, please contact Kontron.

This user guide is protected by copyright. All rights are reserved by Kontron. No part of this document may be reproduced, transmitted, transcribed, stored in a retrieval system, or translated into any language or computer language, in any form or by any means (electronic, mechanical, photocopying, recording, or otherwise), without the express written permission of Kontron. Kontron points out that the information contained in this user guide is constantly being updated in line with the technical alterations and improvements made by Kontron to the products and thus this user guide only reflects the technical status of the products by Kontron at the time of publishing.

Brand and product names are trademarks or registered trademarks of their respective owners.

©2019 by Kontron Europe GmbH

Kontron Europe GmbH

Gutenbergstraße 2

85737 Ismaning

Germany

www.kontron.com

Intended Use

This product, sold by Kontron, is also intended for the use in harsh industrial environments. The product can operate in a temperature range from 0°C to plus 50°C; the storage elements can withstand temperatures from minus 20°C to plus 70°C, and a humidity of 10 to 93 percent does not affect the function of the Product. This makes it particularly suitable for use in industrial automation, process control, high-end image processing and for SCADA/MES applications. This product can be installed in tower, desktop and rackmount environments, as more described in this user manual. You must comply with all product specifications stated in the product documentation and this user manual. If you intend, to incorporate the product into any total systems or applications, please carry out sufficient, compatibility and functions tests prior to any use or resale.

THIS PRODUCT IS NOT DESIGNED, MANUFACTURED OR INTENDED FOR USE OR RESALE FOR THE OPERATION OF APPLICATION IN A HAZARDOUS ENVIRONMENT, OR REQUIRING FAIL-SAFE PERFORMANCE, OR IN WHICH THE FAILURE OF PRODUCTS COULD LEAD DIRECTLY TO DEATH, PERSONAL INJURY, OR SEVERE PHYSICAL OR ENVIRONMENTAL DAMAGE (COLLECTIVELY "HIGH RISK APPLICATIONS").

You understand and agree that your use of Kontron products as a component in High Risk Applications is entirely at your own risk. To minimize the risks associated with your systems and applications, you must provide adequate design and operating safeguards. You are responsible to ensure that your systems (and any Kontron hardware or software products incorporated in your systems) meet all applicable requirements. Unless otherwise stated in the product documentation, the Kontron product is not provided with error-tolerance capabilities and therefore cannot be deemed as being engineered, manufactured or setup to be compliant for implementation or for resale as a component in High Risk Applications. All application and safety related information in this document (including application descriptions, suggested safety measures, suggested Kontron products, and other materials) is provided for reference only.

NOTICE

You find the most recent version of the "General Safety Instructions" online in the download area of this product.

NOTICE

This product is not suited for storage or operation in corrosive environments, in particular under exposure to sulfur and chlorine and their compounds. For information on how to harden electronics and mechanics against these stress conditions, contact Kontron Support.

Revision History

Revision	Brief Description of Changes	Date of Issue	Author/Editor
1.0	Initial version	2019-Feb-13	CW
1.1	Removed noise data. Added No Legacy UEFI Only info, Temperature Sensors and 9 th Gen. Proc. Changed EN/ IEC 60950-1 to EN/IEC 62368, the Mechanical Dimensions Link, Type label and the Block Diagram.	2020-April-06	CW
1.2	Removed Ubuntu and added new logo	2023-Sept-15	CW

Terms and Conditions

Kontron warrants products in accordance with defined regional warranty periods. For more information about warranty compliance and conformity, and the warranty period in your region, visit <https://www.kontron.com/terms-and-conditions>.

Kontron sells products worldwide and declares regional General Terms & Conditions of Sale, and Purchase Order Terms & Conditions. Visit <https://www.kontron.com/terms-and-conditions>.

For contact information, refer to the corporate offices contact information on the last page of this user guide or visit our website [CONTACT US](#).

Customer Support

Find Kontron contacts by visiting: <https://www.kontron.com/support-and-services>.

Customer Service

As a trusted technology innovator and global solutions provider, Kontron extends its embedded market strengths into a services portfolio allowing companies to break the barriers of traditional product lifecycles. Proven product expertise coupled with collaborative and highly-experienced support enables Kontron to provide exceptional peace of mind to build and maintain successful products.

For more details on Kontron's service offerings such as: enhanced repair services, extended warranty, Kontron training academy, and more visit <https://www.kontron.com/support-and-services>.

Customer Comments

If you have any difficulties using this user guide, discover an error, or just want to provide some feedback, contact [Kontron Support](#). Detail any errors you find. We will correct the errors or problems as soon as possible and post the revised user guide on our website.

Symbols

The following symbols may be used in this user guide

⚠ DANGER

DANGER indicates a hazardous situation which, if not avoided, will result in death or serious injury.

⚠ WARNING

WARNING indicates a hazardous situation which, if not avoided, could result in death or serious injury.

NOTICE

NOTICE indicates a property damage message.

⚠ CAUTION

CAUTION indicates a hazardous situation which, if not avoided, may result in minor or moderate injury.



Electric Shock!

This symbol and title warn of hazards due to electrical shocks (> 60 V) when touching products or parts of products. Failure to observe the precautions indicated and/or prescribed by the law may endanger your life/health and/or result in damage to your material.



ESD Sensitive Device!

This symbol and title inform that the electronic products and their components are sensitive to static electricity. Care must therefore be taken during all handling operations and inspections of this product in order to ensure product integrity at all times.



HOT Surface!

Do NOT touch! Allow to cool before servicing.



Laser!

This symbol inform of the risk of exposure to laser beam and light emitting devices (LEDs) from an electrical device. Eye protection per manufacturer notice shall review before servicing.



This symbol indicates general information about the product and the user guide.

This symbol also indicates detail information about the specific product configuration.



This symbol precedes helpful hints and tips for daily use.

For Your Safety

Your new Kontron product was developed and tested carefully to provide all features necessary to ensure its compliance with electrical safety requirements. It was also designed for a long fault-free life. However, the life expectancy of your product can be drastically reduced by improper treatment during unpacking and installation. Therefore, in the interest of your own safety and of the correct operation of your new Kontron product, you are requested to conform with the following guidelines.

High Voltage Safety Instructions

As a precaution and in case of danger, the power connector must be easily accessible. The power connector is the product's main disconnect device.

⚠ CAUTION

Warning

All operations on this product must be carried out by sufficiently skilled personnel only.

⚠ CAUTION



Electric Shock!

Before installing a non-hot-swappable Kontron product into a system always ensure that your mains power is switched off. This also applies to the installation of piggybacks. Serious electrical shock hazards can exist during all installation, repair, and maintenance operations on this product. Therefore, always unplug the power cable and any other cables which provide external voltages before performing any work on this product.

Earth ground connection to vehicle's chassis or a central grounding point shall remain connected. The earth ground cable shall be the last cable to be disconnected or the first cable to be connected when performing installation or removal procedures on this product.

Special Handling and Unpacking Instruction

NOTICE



ESD Sensitive Device!

Electronic products and their components are sensitive to static electricity. Therefore, care must be taken during all handling operations and inspections of this product, in order to ensure product integrity at all times.

⚠ CAUTION

Handling and operation of the product is permitted only for trained personnel within a work place that is access controlled. Follow the "General Safety Instructions for IT Equipment" supplied with the product.

Do not handle this product out of its protective enclosure while it is not used for operational purposes unless it is otherwise protected.

Whenever possible, unpack or pack this product only at EOS/ESD safe work stations. Where a safe work station is not guaranteed, it is important for the operator to be electrically discharged before touching the product with his/her hands or tools. This is most easily done by touching a metal part of your system housing.

It is particularly important to observe standard anti-static precautions when changing piggybacks, ROM devices, jumper settings etc. If the product contains batteries for RTC or memory backup, ensure that the product is not placed on conductive surfaces, including anti-static plastics or sponges. They can cause short circuits and damage the batteries or conductive circuits on the product.

Lithium Battery Precautions

If your product is equipped with a lithium battery, take the following precautions when replacing the battery.

⚠ CAUTION

CAUTION: Risk of Explosion if the lithium battery is replaced by an incorrect type. Dispose of used lithium batteries according to the Instructions.

ATTENTION: Risque d'explosion si la pile au lithium est remplacée par une pile de type incorrect. Éliminez les piles au lithium usagées conformément aux instructions.

General Instructions on Usage

In order to maintain Kontron's product warranty, this product must not be altered or modified in any way. Changes or modifications to the product, that are not explicitly approved by Kontron and described in this user guide or received from Kontron Support as a special handling instruction, will void your warranty.

Install the product only in or connected to systems that fulfill all necessary technical and specific environmental requirements. This also applies to the operational temperature range of the specific product version that must not be exceeded.

In performing all necessary installation and application operations, only follow the instructions supplied within this user guide.

Keep all the original packaging material for future storage or warranty shipments. If it is necessary to store or ship the product then re-pack the product in the same manner as the product was delivered.

Special care is necessary when handling or unpacking the product. Refer to any special handling and unpacking instruction within this user guide.

Quality and Environmental Management

Kontron aims to deliver reliable high-end products designed and built for quality, and aims to complying with environmental laws, regulations, and other environmentally oriented requirements. For more information regarding Kontron's quality and environmental responsibilities, visit <http://www.kontron.com/about-kontron/corporate-responsibility/quality-management>.

Disposal and Recycling

Kontron's products are manufactured to satisfy environmental protection requirements where possible. Many of the components used are capable of being recycled. Final disposal of this product after its service life must be accomplished in accordance with applicable country, state, or local laws or regulations.

WEEE Compliance

The Waste Electrical and Electronic Equipment (WEEE) Directive aims to:

- ▶ Reduce waste arising from electrical and electronic equipment (EEE)
- ▶ Make producers of EEE responsible for the environmental impact of their products, especially when the product become waste
- ▶ Encourage separate collection and subsequent treatment, reuse, recovery, recycling and sound environmental disposal of EEE
- ▶ Improve the environmental performance of all those involved during the lifecycle of EEE



**Environmental protection is a high priority with Kontron.
Kontron follows the WEEE directive.**

Table of Contents

Symbols	6
For Your Safety	7
High Voltage Safety Instructions	7
Special Handling and Unpacking Instruction	7
Lithium Battery Precautions.....	8
General Instructions on Usage	8
Quality and Environmental Management	8
Disposal and Recycling.....	8
WEEE Compliance.....	8
Table of Contents	9
List of Tables	11
List of Figures	11
1/ General Safety Instructions for IT Equipment	12
1.1. Operation of Laser Source Devices	13
1.2. Electrostatic Discharge (ESD).....	13
1.2.1. Grounding Methods	14
1.3. Instructions for the Lithium Battery	14
2/ Introduction	15
3/ Scope of Delivery	16
3.1. Accessories and Spare Parts.....	16
3.2. Shipment, Packaging and Unpacking.....	16
3.3. Type Label.....	16
4/ Product Description	17
4.1. Front Side.....	18
4.1.1. USB Ports	20
4.1.2. Controls and Indicators	20
4.1.3. Front Access Panel.....	21
4.1.4. Fan Assembly	22
4.1.5. Filter Pad and Filter Pad Holder	23
4.1.6. Drive Bays	23
4.2. Rear Side	24
4.2.1. Interfaces on the Rear Side	26
4.2.2. Additional Serial Ports.....	26
4.2.3. Power Supply Unit.....	27
4.2.4. Potential Equalization Stud.....	27
4.3. Sides (Left and Right).....	28
4.4. Cover	29
4.5. System Configuration	30
4.5.1. System Configuration – Mainboard with Low Profile Expansion Cards	30
4.5.2. System Configuration -Mainboard with Riser Expansion Cards.....	31
5/ System Extension	32
5.1. Mass Storage Options.....	32
5.2. Expansion Cards	32
6/ Thermal Considerations	33
6.1. Active Cooling.....	33
6.2. Temperature Sensor	33
6.3. Minimum System Clearance	33

6.4. Third Party Components.....	33
7/ Assembly.....	34
7.1. Opening and Closing the Cover.....	34
7.2. Accessing Internal Components.....	35
7.2.1. Installing and Removing Riser Card Expansion Cards.....	36
7.2.2. Installing and Removing Low Profile Expansion Cards.....	36
8/ Installation.....	37
8.1. Installing the Rubber Feet.....	37
8.2. Removing the Handle Brackets and Front Access Panel Side-Plates.....	38
8.3. Removing the Front Access Panel and Front Access Panel Side-Plates.....	38
8.4. Installing as a Desktop.....	39
8.5. Installing in a 19" Industrial Rack.....	39
8.6. Installing Slide Rails (Option).....	40
9/ Starting Up.....	42
9.1. Connecting the Power Connection.....	42
9.2. Operating System and Hardware Component Drivers.....	43
10/ Maintenance and Prevention.....	44
10.1. Cleaning the Filter Pad.....	44
10.2. Replacing the Fan Assembly.....	46
10.3. Replacing the Lithium Battery.....	47
11/ Technical Data.....	48
11.1. Block Diagrams.....	48
11.2. Technical Specification.....	50
11.3. Power Specification.....	51
11.4. Mechanical Specification.....	51
11.5. Environmental Specification.....	51
11.6. CE Directives and Standards.....	52
12/ Standard Interfaces- Pin Assignments.....	54
12.1. Keyboard Connector Pin Assignment.....	54
12.2. PS/2 Mouse Connector Pin Assignment.....	54
12.3. USB 2.0 Port Pin Assignment.....	54
12.4. Display Port Pin Assignment.....	55
12.5. COM 1 Connector Pin Assignment.....	55
12.6. DVI-D Connector Pin Assignment.....	55
12.7. LAN Connector Pin Assignment.....	56
12.8. USB 3.0 and USB 3.1 (Gen1/Gen2) Port Pin Assignment.....	56
12.9. Audio Jack Pin Assignment.....	56
13/ Technical Support.....	57
13.1. Returning Defective Merchandise.....	57
14/ Storage and Transportation.....	59
14.1. Storage.....	59
14.2. Transportation.....	59
15/ Warranty.....	60
15.1. Limitation/Exemption from Warranty Obligation.....	60
16/ Disposal.....	61
List of Acronyms.....	62
About Kontron.....	63

List of Tables

Table 1: Scope of delivery	16
Table 2: Accessories and spares parts.....	16
Table 3: Power LED and HDD LED activity description.....	21
Table 4: Drive bays.....	23
Table 5: Mass storage devices.....	32
Table 6: Expansion slots	32
Table 7: List of Acronyms.....	62

List of Figures

Figure 1: Laser radiation warning label	13
Figure 2: Type label.....	16
Figure 3: Rackmount variant (closed front access panel).....	17
Figure 4: Desktop variant (closed front access panel).....	17
Figure 5: Rackmount variant (opened front access panel).....	17
Figure 6: Desktop variant (opened front access panel).....	17
Figure 7: Front side with front access panel closed	18
Figure 8: Handle bracket with fastening screws	18
Figure 9: Front side with front access panel open.....	19
Figure 10: Power button and USB 2.0 ports.....	20
Figure 11: LED indicators.....	21
Figure 12: Fan assembly.....	22
Figure 13: Rear side with micro-ATX mainboard with riser card.....	24
Figure 14: Rear side with micro-ATX mainboard with low profile cards.....	25
Figure 15: External mainboard interface panel KISS 2U Short V3 CFL	26
Figure 16: PSU 400W AC	27
Figure 17: Left side.....	28
Figure 18: Right side.....	28
Figure 19: Underside of cover with fixing brackets	29
Figure 20: Configuration with micro-ATX mainboard and low profile expansion cards.....	30
Figure 21: Configuration with micro-ATX mainboard and riser expansion cards.....	31
Figure 22: Loosening knurled screw on the front side	34
Figure 23: Loosening knurled screws on the rear side.....	34
Figure 24: Pull and release the cover	35
Figure 25: Removing the cover.....	35
Figure 26: Pulled-out card cage screws	36
Figure 27: Front access panel side-plate with handle bracket.....	38
Figure 28: Slide rail inner part fastened to chassis	41
Figure 29: Slide rail in pulled-out position	41
Figure 30: Slide rail in pushed-in position.....	41
Figure 31: Assembling the slide rails in an industrial rack cabinet	41
Figure 32: Input power socket.....	42
Figure 33: Front side with filter pad holder	44
Figure 34: Front side without filter pad.....	45
Figure 35: Filter pad holder (without filter pad)	45
Figure 36: Filter pad holder (with filter pad).....	45
Figure 37: Filter pad	45
Figure 38: Removing the fan assembly.....	46
Figure 39: Fan compartment without fan assembly	46
Figure 40: Block diagram KISS 2U Short V3 CFL Low Profile.....	48
Figure 41: Block diagram KISS 2U Short V3 CFL Riser Card.....	49

1/ General Safety Instructions for IT Equipment

Please read this passage carefully and take careful note of the instructions, which have been compiled for your safety and to ensure to apply in accordance with intended regulations. If the following general safety instructions are not observed, it could lead to injuries to the operator and/or damage of the product; in cases of non-observance of the instructions Kontron Europe is exempt from accident liability, this also applies during the warranty period.

The product has been built and tested according to the basic safety requirements for low voltage (LVD) applications and has left the manufacturer in safety-related, flawless condition. To maintain this condition and to also ensure safe operation, the operator must not only observe the correct operating conditions for the product but also the following general safety instructions:

- ▶ The product must be used as specified in the product documentation, in which the instructions for safety for the product and for the operator are described. These contain guidelines for setting up, installation and assembly, maintenance, transport or storage.
- ▶ The on-site electrical installation must meet the requirements of the country's specific local regulations.
- ▶ If a power cable comes with the product, only this cable should be used. Do not use an extension cable to connect the product.
- ▶ To guarantee that sufficient air circulation is available to cool the product, please ensure that the ventilation openings are not covered or blocked. If a filter mat is provided, this should be cleaned regularly. Do not place the product close to heat sources or damp places. Make sure the product is well ventilated.
- ▶ Only connect the product to an external power supply providing the voltage type (AC or DC) and the input power (max. current) specified on the Kontron Product Label and meeting the requirements of the Limited Power Source (LPS) and Power Source (PS2) of UL/IEC 62368-1 .
- ▶ Only products or parts that meet the requirements for Power Source (PS1) of UL/IEC 62368-1 may be connected to the product's available interfaces (I/O).
- ▶ Before opening the product, make sure that the product is disconnected from the mains.
- ▶ Switching off the product by its power button does not disconnect it from the mains. Complete disconnection is only possible if the power cable is removed from the wall plug or from the product. Ensure that there is free and easy access to enable disconnection.
- ▶ The product may only be opened for the insertion or removal of add-on cards (depending on the configuration of the product). This may only be carried out by qualified operators.
- ▶ If extensions are being carried out, the following must be observed:
 - ▶ all effective legal regulations and all technical data are adhered to
 - ▶ the power consumption of any add-on card does not exceed the specified limitations
 - ▶ the current consumption of the product does not exceed the value stated on the product label
- ▶ Only original accessories that have been approved by Kontron Europe can be used.
- ▶ Please note: safe operation is no longer possible when any of the following applies:
 - ▶ the product has visible damages or
 - ▶ the product is no longer functioning
 In this case the product must be switched off and it must be ensured that the product can no longer be operated.
- ▶ Handling and operation of the product is permitted only for trained personnel within a work place that is access controlled.
- ▶ CAUTION: Risk of explosion if the lithium battery is replaced incorrectly (short-circuited, reverse-poled, wrong battery type). Dispose of used batteries according to the manufacturer's instructions.
- ▶ This product is not suitable for use in locations where children are likely to be present

Additional Safety Instructions for DC Power Supply Circuits

- ▶ To guarantee safe operation, please observe that:
 - ▶ the external DC power supply must meet the criteria for LPS and PS2 (UL/IEC 62368-1)

- ▶ no cables or parts without insulation in electrical circuits with dangerous voltage or power should be touched directly or indirectly
- ▶ a reliable functional earth connection is provided
- ▶ a suitable, easily accessible disconnecting device is used in the application (e.g. overcurrent protective device), if the product itself is not disconnectable
- ▶ a disconnect device, if provided in or as part of the product, shall disconnect both poles simultaneously
- ▶ interconnecting power circuits of different products cause no electrical hazards
- ▶ A sufficient dimensioning of the power cable wires must be selected – according to the maximum electrical specifications on the product label – as stipulated by EN62368-1 or VDE0100 or EN60204 or UL61010-1 regulations.

1.1. Operation of Laser Source Devices

Figure 1: Laser radiation warning label

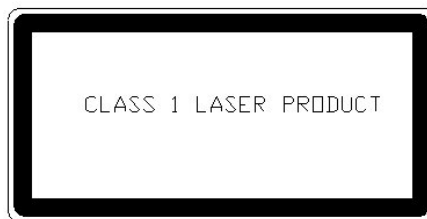

The optional DVD drive contains light-emitting diodes (LEDs) (classified in accordance with IEC 60825-1:2007: LASER CLASS 1) and therefore must not be opened. If the enclosure of such a drive is opened, invisible laser radiation is emitted. Do not allow yourself to be exposed to this radiation.

The laser system meets the Code of Federal Regulations (CFR), Title 21, 1040 -Performance standards for light-emitting products.



Laser!

Risk of exposure to laser beam and light emitting devices (LEDs) from DVD

- ▶ Do not open DVD drive due to invisible laser radiation.
 - ▶ Check manufacture instructions eye protection maybe required.
-

1.2. Electrostatic Discharge (ESD)



A sudden discharge of electrostatic electricity can destroy static-sensitive devices.

Proper packaging and grounding techniques are necessary precautions to prevent damage. Always take the following precautions:

1. Transport ESD-sensitive products in ESD-safe containers such as boxes or bags.
2. Keep electrostatic sensitive parts in their containers until they arrive at the ESD-safe workplace.
3. Always be properly grounded when touching sensitive products, components, or assembly.
4. Store electrostatic-sensitive products in protective packaging or on antistatic mats.

1.2.1. Grounding Methods

To avoid electrostatic damage, observe the following grounding guidelines:

1. Cover workstations with approved antistatic material. Always wear a wrist strap connected to the workplace. Always use properly grounded tools and equipment.
2. Use antistatic mats, heel straps, or air ionizers for more protection.
3. Always handle electrostatically sensitive components by their edge or by their casing.
4. Avoid contact with pins, leads, or circuitry.
5. Switch off power and input signals before inserting and removing connectors or connecting test equipment.
6. Keep work area free of non-conductive materials such as ordinary plastic assembly aids and Styrofoam.
7. Use only field service tools that are conductive, such as cutters, screwdrivers, and vacuum cleaners.
8. Always place drives and any boards PCB-assembly-side down on the foam.

1.3. Instructions for the Lithium Battery

When replacing the mainboard's lithium battery observe the instructions described in Chapter 10.3: Replacing the Lithium Battery.

CAUTION

CAUTION: Risk of Explosion if the lithium battery is replaced by an incorrect type. Dispose of used lithium batteries according to the Instructions.

ATTENTION: Risque d'explosion si la pile au lithium est remplacée par une pile de type incorrect. Éliminez les piles au lithium usagées conformément aux instructions.



Do not dispose of lithium batteries in general trash collection. Dispose of the battery according to the local regulations dealing with the disposal of these special materials, (e.g. to the collecting points for dispose of batteries).

2/ Introduction

This user guide focuses on describing the special features of the KISS 2U Short V3 made by Kontron. New users are recommended to study the instructions within this user guide before switching on the power.

The KISS 2U Short V3 is a scalable 2U rackmount system equipped with a micro-ATX mainboard, using Intel's® 7th/8th/9th generation processors and supporting multiple expansion capabilities and external interfaces. Additionally, the short form factor offers an optimal trade-off between space and performance.

The KISS 2U Short V3 is designed for high performance, reliability and use in in harsh Industrial environments offering total flexibility with installation options in a 19" industrial rack or on a desktop.

General KISS 2U Short V3 CFL features are:

- ▶ micro-ATX mainboard
- ▶ Supporting Intel® Core™ i3, i5 and i7 series series 7th/8th/9th Gen and Intel® Xeon E-21XX series
- ▶ Intel® C246 Express chipset
- ▶ Up to 64 GB memory with 4x DDR4-2666 UDIMM/ECC support with Xeon E
- ▶ Expansion slots:
 - ▶ 4x PCIe slots (low profile card) or
 - ▶ 3x PCIe slots (full height, half length)
- ▶ Mass storage capabilities with M.2 socket ,HDD, SSD and DVD devices
- ▶ External Interfaces for 4x USB 2.0, 4x USB 3.1, 2x DP 1.2 , 1x DVI-D, Serial port, 2x 1 Gb Ethernet, audio, keyboard and mouse
- ▶ Active cooling

3/ Scope of Delivery

Check that your delivery is complete, and contains the items listed in Table 1: Scope of delivery. If damaged or missing items are discovered, contact the dealer.

Table 1: Scope of delivery

Part	Qty.	Part Description
KISS 2U Short V3	1	System configuration as ordered
Access key	2	Opens front access panel lock
Rubber feet	4	Self-adhesive
AC power cable	1	With Europe rating, other cable ratings are optional
Safety instructions	1	Safety Instructions for IT equipment

3.1. Accessories and Spare Parts

Table 2: Accessories and spares parts

	Part Number	Part Description
Accessories	1016-5807	Slide rails (Short)
	1051-7200	Mounting kit slide rail (Short)
Spare parts	1050-8374	Filter pad
	1050-8442	Fan assembly

3.2. Shipment, Packaging and Unpacking

The KISS 2U Short V3 is packed together with all standard parts in a product specific cardboard packaging with suitable shock absorbers inside. Each item is packaged separately.

3.3. Type Label

Figure 2: Type label example



4/ Product Description

The KISS 2U Short V3 expands the Kontron KISS computer line. KISS 2U Short V3 is a scalable 2U rackmount system equipped with a micro-ATX mainboard. The flexible customer-specific hardware system configuration and the robust construction with excellent mechanical stability offers the superior qualities of a computer designed for operation in harsh industrial environments. The KISS 2U Short V3's design enables installation in 19" industrial racks or as a desktop.

Figure 3: Rackmount variant (closed front access panel) Figure 4: Desktop variant (closed front access panel)



Figure 5: Rackmount variant (opened front access panel) Figure 6: Desktop variant (opened front access panel)



The KISS 2U Short V3 is design for horizontal operation. Vertical operation is possible.

The KISS 2U Short V3 can be equipped with up to three drive bays, where drive bays D1 and D2 are front accessible and drive bay D3 is internal.

The power button is located on the front side behind the front access panel. The LED indicators are located on the front side and consist of a power LED and a hard disk activity LED.

The KISS 2U Short V3 comes with a 400 W Power Supply Unit (PSU) with an input voltage range of 100 V to 240 V.

Two system fans are installed at the front side of the product. The two system fans are attached to the product by means of a slide-in fan assembly. The fan assembly simplifies the installation and removal of the two system fans and enables replacement even during operation.

A washable filter pad attaches to the fan assembly to protect the product against dust and dirt. The filter pad can be replaced during operation.

Depending on the integrated CPU micro-ATX mainboard the KISS 2U Short V3 can be expanded with different expansion cards.

When powering on the KISS 2U Short V3 make sure that the ventilation holes (air intake and air exhaust), are not obstructed by objects.

4.1. Front Side

The front side consists of two handle brackets for installation in a 19" Industrial rack and a front access panel with two front access panel side-plates attached via the handle brackets.

Figure 7: Front side with front access panel closed

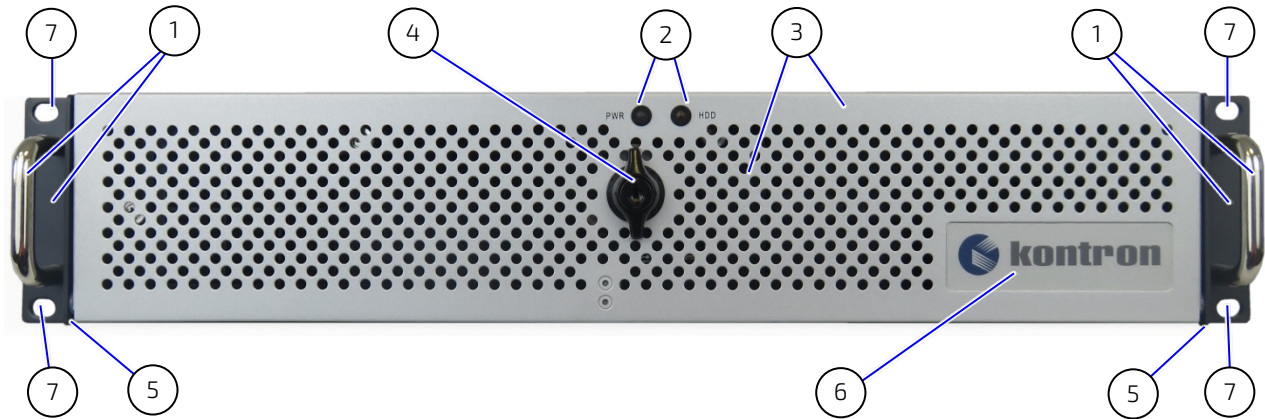

- | | |
|---|--|
| 1. Handle brackets | 4. Key lock for the front access panel |
| 2. LED indicators | 5. Front access panel side-plates |
| 3. Front access panel with air intake ventilation holes | 6. Kontron logo |
| | 7. Mounting holes for 19" racks |

For use on a desktop, remove both handle brackets (right side and left side), see Chapter 8.2: Removing the Handle Brackets and attach the rubber feet (included in delivery), see Chapter 8.1: Installing the Rubber Feet. Depending on the security requirements, the lockable front access panel and two front access panel side-plates can be removed or left in-place.

Figure 8: Handle bracket with fastening screws

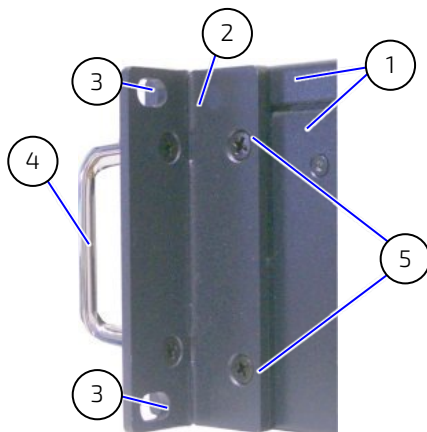

- | |
|---|
| 1. Chassis and cover |
| 2. Handle bracket |
| 3. Mounting holes for 19" racks |
| 4. Handle |
| 5. Screws to fasten handle bracket to chassis |

The power button, LED Indicators, two USB 2.0 ports, filter pad holder and the integrated drives are located on the front side of the product behind the front access panel.

Figure 9: Front side with front access panel open

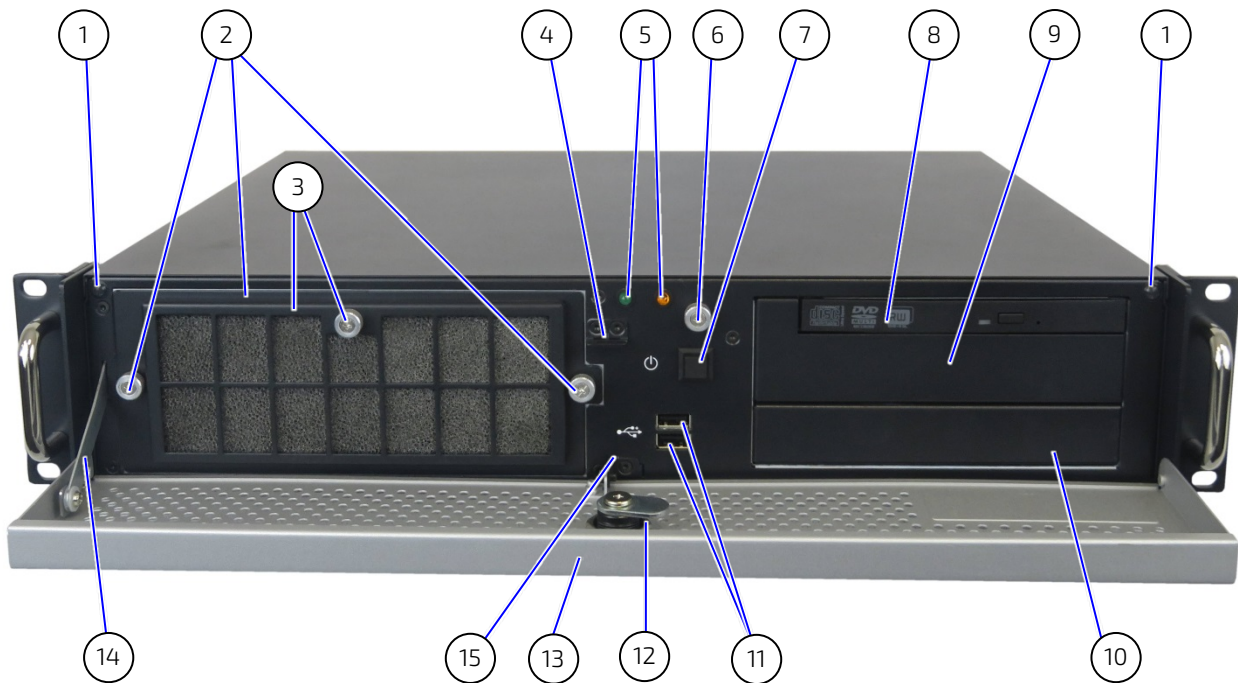

- | | |
|--|--|
| 1. Bump stop for the front access panel | 9. D2: 3.5" drive bay for 2.5" drives |
| 2. Fan assembly with two knurled screws | 10. D3: 3.5" Internal drive bay for 3.5" or 2.5" drives |
| 3. Filter pad holder with filter pad and knurled screw | 11. 2x USB (2.0) ports |
| 4. Slot for the locking mechanism | 12. Locking mechanism on front access panel |
| 5. Indicators (Power LED and HDD LED) | 13. Front access panel with air intake ventilation holes |
| 6. Cover fastening screw on the front side | 14. Holder arm for the front access panel |
| 7. Power button | 15. Central hinge for the front access panel |
| 8. D1: slim drive bay for slim DVD | |

4.1.1. USB Ports

The two USB 2.0 ports are located on the front side of the product (Figure 9, pos.11 and Figure 10, pos. 2), behind the front access panel.

Figure 10: Power button and USB 2.0 ports

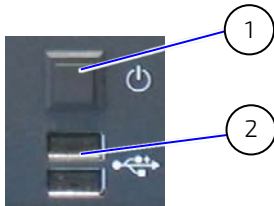

1. Power button
2. USB (2.0) ports



If USB devices are connected to the USB ports on the front side, the front access panel door cannot be closed and locked.

4.1.2. Controls and Indicators

4.1.2.1. Power Button

The power button (Figure 9, pos. 7 and Figure 10, pos. 1) is located on the front side of the product, behind the front access panel. Press the power button to switch on or switch off the product.

Pressing the power button for longer than four seconds initiates a forced system shutdown before the power to the product is switched off.

⚠ WARNING

The power button does not disconnect from the mains power supply. When switched off using the power button, there is still a standby voltage of 5 VSB on the mainboard.

⚠ WARNING

AC Power cable and power connectors must always remain easily accessible. The KISS 2U Short V3 is only completely disconnected from the mains power supply when the power cable is disconnected, from the mains power socket or the KISS 2U short V3's AC input power connector (Figure 13, Figure 14, pos. 1).
If the end environment restricts access to the power cable, disconnection must be guaranteed using a separate cut-off fixture.

NOTICE

Performing a forced shutdown can lead to loss of data or other undesirable effects!

4.1.2.2. Power LED and HDD Activity LED

The indicators (Figure 9, pos. 5 and Figure 11) of the KISS 2U Short V3 are located on the front side, behind the front access panel.

Figure 11: LED indicators



- 1 Power LED
- 2 HDD activity LED

Table 3: Power LED and HDD LED activity description

Power LED (green)	LED illuminates (green) when the product is switched on by pressing the power button. Prerequisite: Connection to an appropriate AC/DC power source.
HDD LED (orange)	LED lights up during hard disk activity

4.1.3. Front Access Panel

The securing lock mechanism (Figure 7, pos. 4) located on the front access panel protects against unauthorized use. When locked the front access panel cannot be opened, and the drives, filter pad holder and power button are not accessible.

The KISS 2U Short V3 can be operated without the front access panel, see Chapter 8.3: Removing the Front Access Panel and Front Access Panel Side-Plates.



Front access panel key must be kept safe and not be accessible to unauthorized persons.



If USB devices are connected to the USB ports on the front side, the front access panel door cannot be closed or locked.

4.1.4. Fan Assembly

The Fan assembly consists of two system fans (Figure 12, pos. 3) integrated in a user-friendly, replaceable fan assembly (hot-swap) mountable in a fan compartment on the front side of the product. The two system fans are temperature controlled via temperature sensors, to provide adequate airflow for optimal active cooling. For information on how to replace the fan assembly, see Chapter 10.2: Replacing the Fan Assembly.

Figure 12: Fan assembly

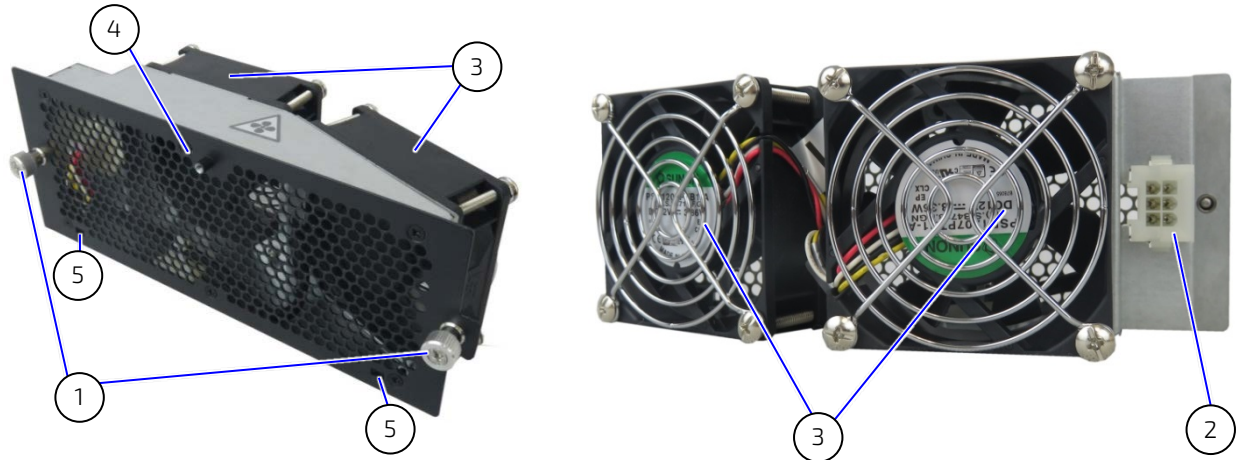

1. Two knurled screws
2. Connector for fan control
3. 2x fans (temperature controlled independently from each other)
4. Bolt with tapped hole screw
5. Positioning holes for filter pad holder's positioning latches

⚠ CAUTION

Operation is permitted only with a functional fan assembly!
Replace a defective fan assemble only with an original fan assembly.

⚠ CAUTION

Fan assembly replaceable during operation
Replace the fan assembly only by trained personnel aware of the associated dangers.
Before removing the fan assembly, wait until the fans have totally stopped. Keep hands and fingers away from rotating fan parts.



The filter pad holder can be fasten to the front side of the fan assembly either before or after the fan assembly is installed.

4.1.5. Filter Pad and Filter Pad Holder

The filter pad and the filter pad holder (Figure 9, pos. 3) are located behind the front access panel (Figure 7, pos. 3). The filter pad protects the product from dust and dirt and will over time become soiled by pollution. If heavily soiled, the filter pad can cause excessive heating of the product. Kontron recommends cleaning the filter pad as often as necessary, see Chapter 10.1: Cleaning the Filter Pad.



The filter pad can be changed during operation.

The filter pad inserts into the filter pad holder. The filter pad holder fastens onto the fan assembly's front side by inserting the filter pad holder's positioning latches into the fan assembly's position holes (Figure 12, pos. 5) and then fastening the filter pad holder's knurled screw (Figure 9, pos. 3)

4.1.6. Drive Bays

The KISS 2U Short V3 can be equipped with up to three drive bays D1, D2 and D3. Drive bays D1, D2 are front accessible (Figure 9, pos. 8 and 9) and drive bay D3 (Figure 9, pos. 10) is internally accessible.

Table 4: Drive bays

Drive Bay	Location	Description
D1	Front access	one slim drive bay for slim DVD drives
D2		one 3.5" drive bay for 2.5" drives
D3	Internal	one 3.5" drive bay for 3.5" or 2.5" drives

The drives D1, D2 and D3 can be used as separate drives or configured as a RAID array using the mainboard's chipset RAID.



Refer to the chipset specification for the RAID type and Intel® Rapid Storage Technology availability.

For additional storage, use the on-board M.2 slot with a M.2 memory module, see Chapter 5/System Extension.

4.2. Rear Side

The rear panel includes the external interfaces of the integrated mainboard, any expansion cards interfaces/ports, power supply unit (PSU) socket, and air exhaust ventilation holes.



The positioning and number of interfaces varies depending on the system configuration.

Figure 13: Rear side with micro-ATX mainboard with riser card

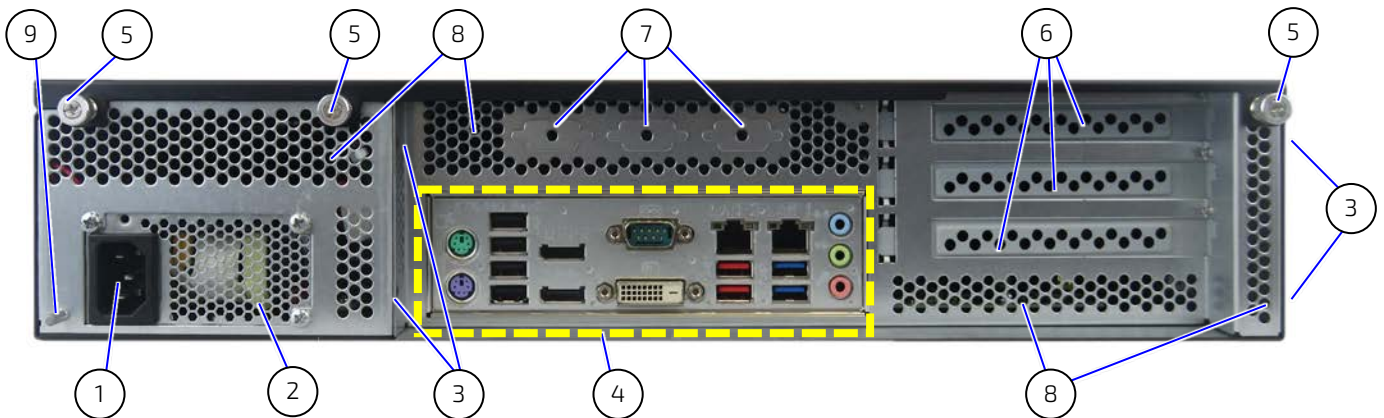

- | | |
|---|---|
| 1. Input power socket | 6. Slot brackets for expansion cards |
| 2. Power Supply Units (PSU) ventilation holes | 7. Cut-outs for optional interfaces routed to the rear (9-pin D-SUB type) |
| 3. Card cage (for mainboard board and expansion cards) fastening screws | 8. Ventilation holes (air exhaust) |
| 4. Mainboard external interfaces of mainboard | 9. Potential equalization stud |
| 5. Three cover fastening knurled screws | |

Figure 14: Rear side with micro-ATX mainboard with low profile cards

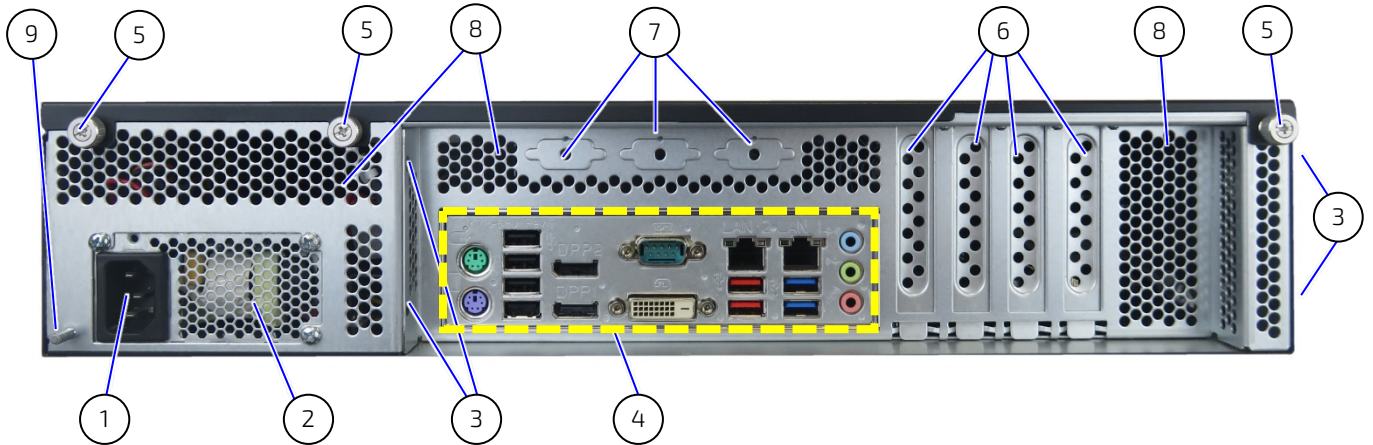

- | | |
|--|---|
| 1. Input power socket | 6. Slot brackets for expansion cards |
| 2. Power Supply Unit (PSU) ventilation holes | 7. Cut-outs for optional interfaces routed to the rear (9-pin D-SUB type) |
| 3. Card cage external fastening screws (for the mainboard board and expansion cards) | 8. Ventilation holes (air exhaust) |
| 4. Mainboard external interfaces | 9. Potential equalization stud |
| 5. Rear side of the cover with three knurled screws | |

4.2.1. Interfaces on the Rear Side

Depending on the installed mainboard, the following external interfaces are available for peripherals.

4.2.1.1. External Interfaces KISS 2U Short V3 CFL

Figure 15: External mainboard interface panel KISS 2U Short V3 CFL

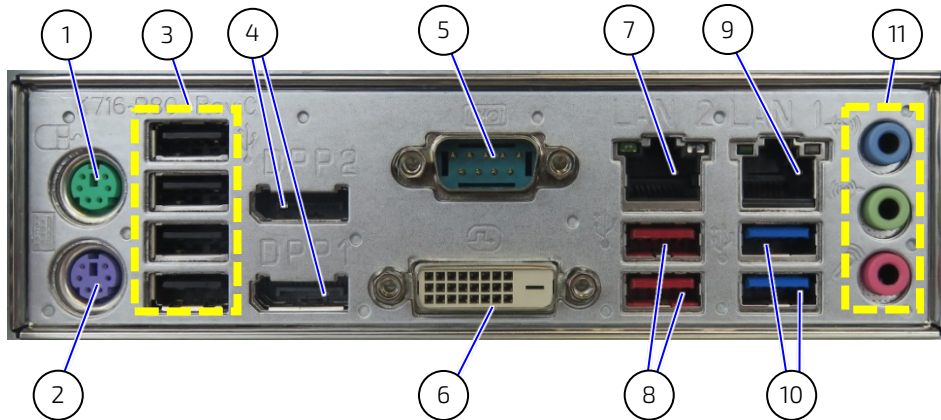

- | | | | |
|---|-------------------|----|---------------------------|
| 1 | Mouse | 7 | LAN2 |
| 2 | Keyboard | 8 | 2x USB 3.1 (Gen 2) Type A |
| 3 | 4x USB 2.0 | 9 | LAN1 (iAMT) |
| 4 | 2x DP V1.2 | 10 | 2x USB 3.1 (Gen 1) Type A |
| 5 | Serial port (COM) | 11 | Audio jacks |
| 6 | DVI-D | | |

4.2.2. Additional Serial Ports

The mainboard's on-board interfaces such as serial ports can be routed to the rear panel (see Figure 13 and Figure 14, pos.7).



For information and technical data, refer to the installed mainboard's user guide.

4.2.3. Power Supply Unit

The Power Supply Unit (PSU) is located on the rear side of the product and supplies the required internal 12V, 5V and 3.3V voltages using standard certified cabling. The KISS 2U ShortV3 supports a 400 W PSU with a nominal voltage range 100 V to 240 V. For more information, see Chapter 11.3: Power Specification.

⚠ WARNING

Even when switched off using the power button parts of the product may still be energized! The product is only completely switched off by switching off power using the power button and disconnecting the power cable from the mains power supply or Input power socket.

⚠ WARNING

AC Power cable and power connectors must always remain easily accessible. If the end environment restricts access to the power cable, disconnection must be guaranteed using a separate cut-off fixture.

NOTICE

Do not disconnect the power from the product while the product is switched on! Performing a forced shut down may lead to loss of data or other undesirable effects! Switch off using the power button to perform an orderly shutdown without data loss.

Figure 16: PSU 400W AC



The 400 W PSU is a single PSU. A redundant PSU is not supported.

4.2.4. Potential Equalization Stud

The potential equalization stud is located on the rear side of the product (Figure 13 and Figure 14, pos. 9). The potential equalization stud is not a ground connection. When connected the potential equalization stud ensures that all connected systems share a common potential.



The potential equalization stud is not a ground connection. The potential equalization stud ensures that all connected systems share a common potential.

4.3. Sides (Left and Right)

On the left and right sides of the KISS 2U Short V3 there are four M4 tapped screw holes (Figure 17, Figure 18, pos. 1) used for installation in a 19" industrial rack with slide rails.

Figure 17: Left side

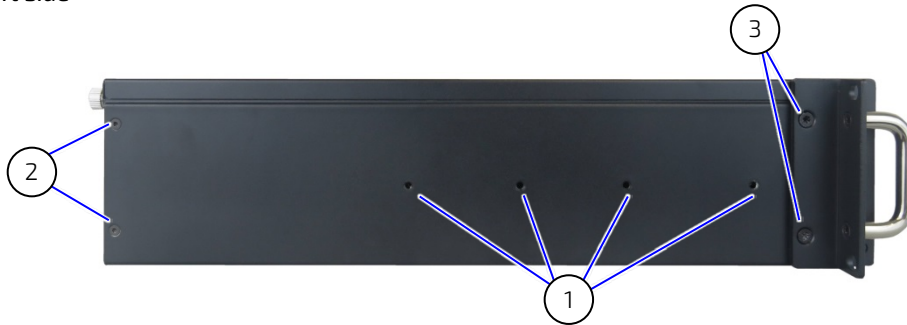
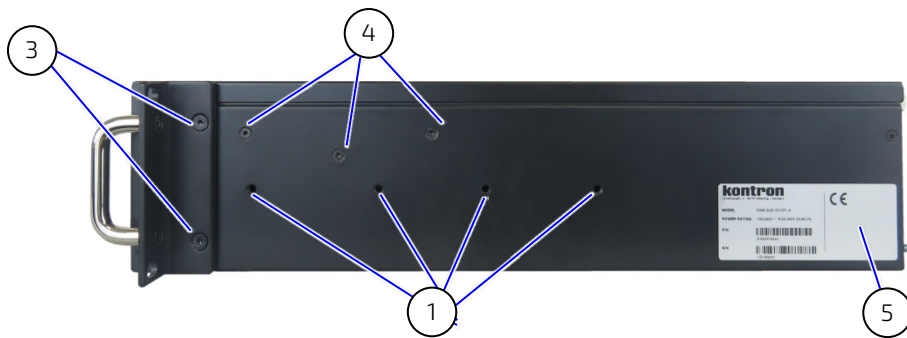

Figure 18: Right side



- | | |
|---|---|
| 1. 4x M4 tapped holes (on both sides) | 3. Handle bracket screws |
| 2. Card cage (for mainboard board and expansion cards) fastening screws | 4. Drives cages holder fastening screws (do not remove) |
| | 5. Type label |

4.4. Cover

⚠ WARNING

Energy hazards-240 VA present inside the chassis!

Before removing the top cover. Switch off the product properly by using the power switch on the front side and disconnecting the power cable from the mains power supply.

⚠ WARNING

Recommended intended used is closed and locked

Only when the cover is secured is it ensured that the operator does not have access to the internal parts, loaded with hazardous energy. To close properly secure the cover knurled screws: one front side screw and three rear side screws.

The cover fixes to the main chassis using fixing brackets on the front side of the cover and fastens using three knurled screws on the cover's rear side and one knurled screw on the cover's front side. For more information on how to open the cover, see Chapter 7.1: Opening and Closing the Cover.

Figure 19: Underside of cover with fixing brackets

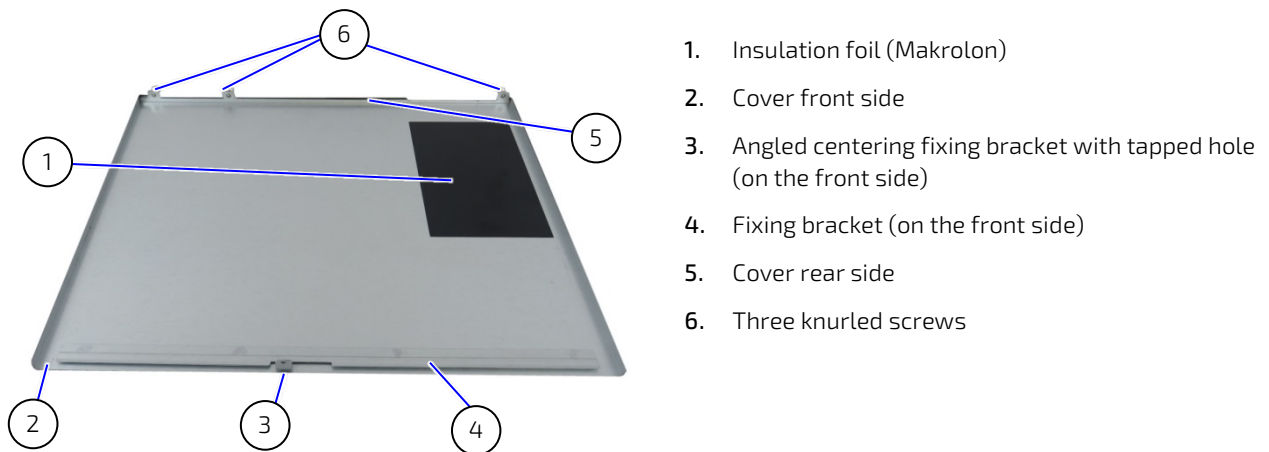

4.5. System Configuration

4.5.1. System Configuration – Mainboard with Low Profile Expansion Cards

Figure 20: Configuration with micro-ATX mainboard and low profile expansion cards

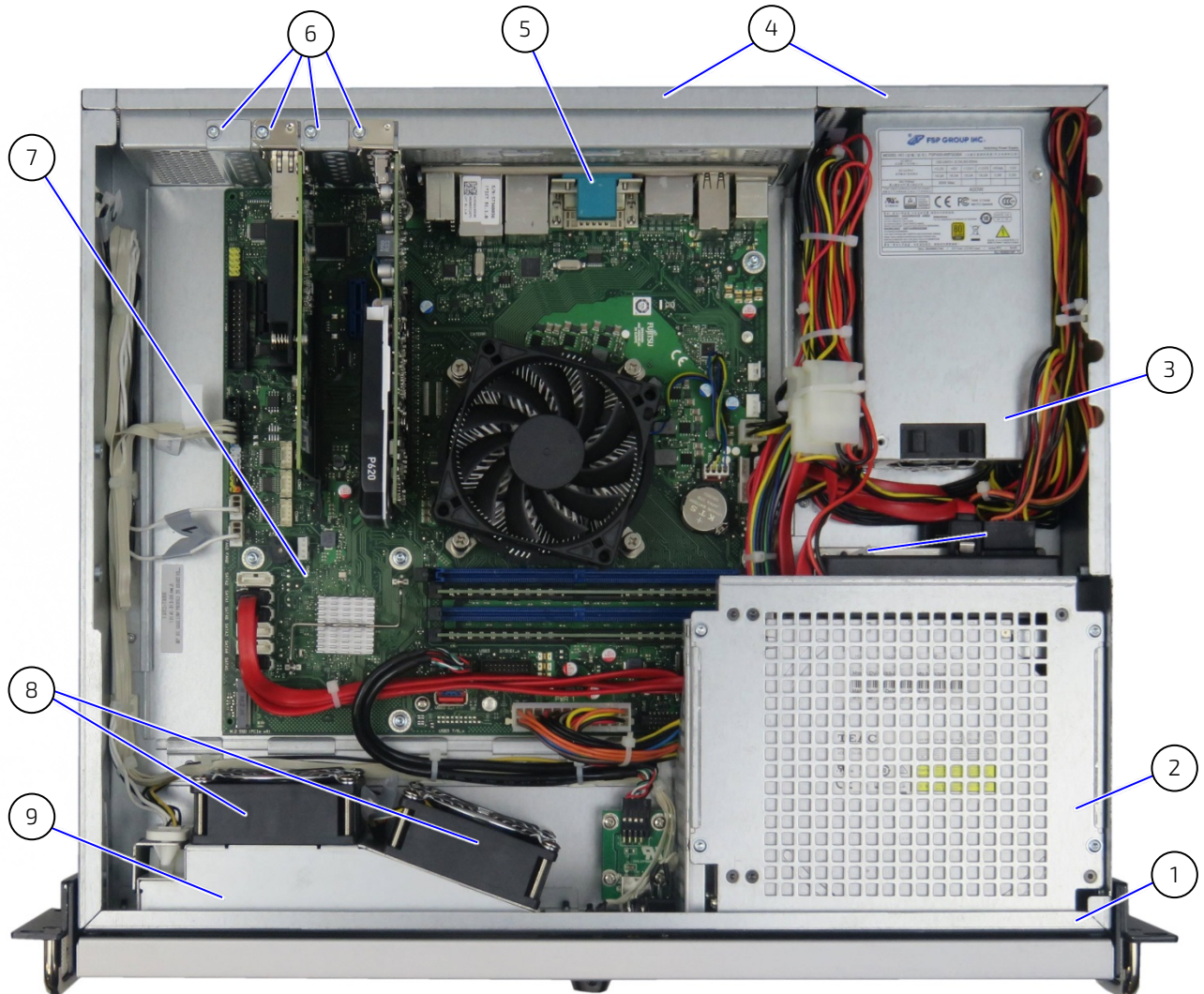

- | | |
|--|---|
| 1. Cover retaining plate on the front side | 6. Fastening screws for the slot brackets or expansion card slot brackets |
| 2. D1, D2 and D3 : drives bays (stacked one above the other into a drive cage) | 7. Mainboard |
| 3. Power Supply Unit (PSU) | 8. Fans (of the fan assembly) |
| 4. Cover retaining plates on the rear side | 9. Fan assembly (hot-swap) |
| 5. Interface connectors (available externally) | |

4.5.2. System Configuration -Mainboard with Riser Expansion Cards

Figure 21: Configuration with micro-ATX mainboard and riser expansion cards

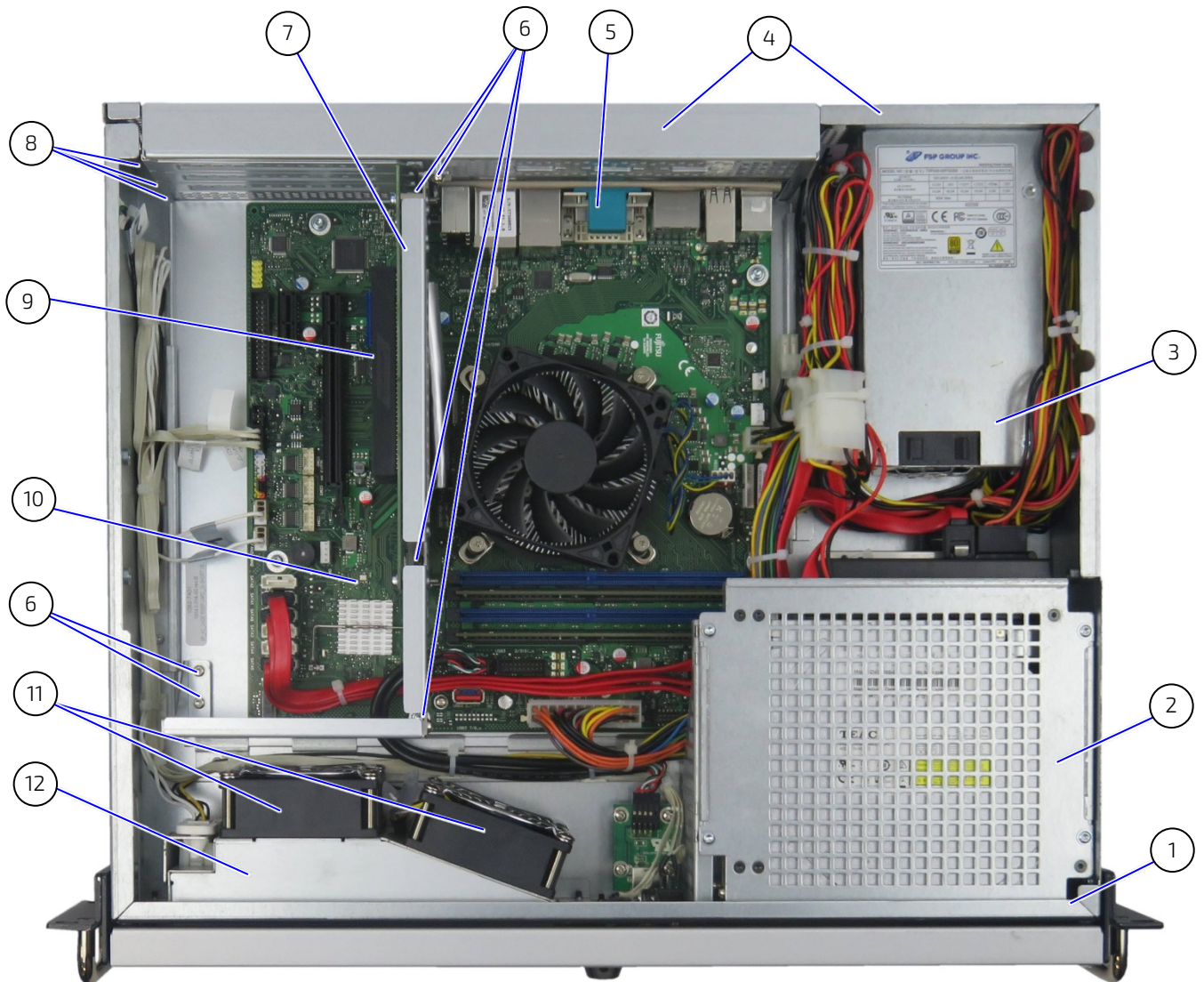

- | | |
|--|---|
| 1. Cover retaining plate on the front side | 7. Retaining bracket for riser cards (not provided for system configuration with low profile cards) |
| 2. D1, D2 and D3 : drives bays (stacked one above the other into a drive cage) | 8. Fastening screws for the slot brackets or expansion card slot brackets |
| 3. Power Supply Unit (PSU) | 9. Riser card with expansion slots |
| 4. Cover retaining plates on the rear side | 10. Mainboard |
| 5. Interface connectors (available externally) | 11. Fans (of the fan assembly) |
| 6. Fastening screws for riser card retaining bracket | 12. Fan assembly (hot-swap) |

5/ System Extension



Due to the limited lifespan of expansion devices, Kontron recommends checking the condition of any installed expansion devices regularly and to pay attention to the manufacturer's lifespan specifications.

5.1. Mass Storage Options

An additional internal drive is configurable in systems where the mainboard includes an on-board M.2 slot for a, M.2 2280 memory module. RAID support is not available for an on-board M.2 memory module.

Table 5: Mass storage devices

Drive Bay	Description
On-board M.2 slot	M2.2280 (key M) PCIe drive



RAID support is not available for the on-board M.2 memory module.

5.2. Expansion Cards

The following slots are available for expansion on the rear side of the chassis.

Table 6: Expansion slots

Installed Mainboard	Expansion Card Type	Description
micro-ATX (CFL)	Riser cards	Up to 3x PCIe, (full height, half length)
	Low Profile cards	Up to 4x PCIe (low profile) Slot 1: PCIe x16 Gen3 (16 lanes) Slot 2: PCIe x1 Gen 3 (open slot) Slot 3: PCIe x16 Gen3 (4 lane) Slot 4: PCIe x1 Gen 3



For PCIe/PCI slot functionality and location information, refer to the manufacture's "Product Information". For the mainboard name and type, see Chapter 11.2: Technical Specification.



Before extending the product with expansion cards consider the maximum power consumption allowed by the PSU.

6/ Thermal Considerations

6.1. Active Cooling

The KISS 2U Short V3 is forced air-cooled using two internal system fans that force air to flow from the front to the back of the chassis. The processor and expansion cards have integrated cooling solutions or are equipped with corresponding cooling devices.

If a filter pad is used, clean the filter pad regularly to ensure that sufficient airflow is provided, see Chapter 10.1: Cleaning the Filter Pad.

6.2. Temperature Sensor

The temperature conditions of the product (depending on the environmental temperature and the load) are detected by two internal temperature sensors (one at the rear and one near the fan assembly) that control the speed of the system fans within the fan assembly accordingly.

6.3. Minimum System Clearance

To guarantee that sufficient air flows from the front to the back of the chassis, ensure that the ventilation holes are not covered, blocked or obstructed by surrounding parts.

Before installing the KISS 2U Short V3 take into account, any thermal considerations mentioned in Chapter 8/: Installation, such as airflow obstructions and the correct mount orientation.

⚠ WARNING

Ensure Sufficient Airflow

Ensure that the 19" rack cabinet is well ventilated and does not prevent the KISS 2U Short V3 from taking in air at the front and exhausting air at the rear.

⚠ WARNING

Do not place the product close to heat sources or damp places.



There are no ventilation restrictions above and below the product, enabling installation directly on top of or below another system.

6.4. Third Party Components

When the KISS 2U Short V3 is extended and configured with third party components such as PCIe expansion cards, M.2 module, DIMMs and drives (HDD, SSD and DVD), there is an internal temperature rise. Thus, the air temperature inside the product is higher than the ambient air temperature around the product.

7/ Assembly

No special tools are required to open the KISS 2U Short V3. Before opening the KISS 2U Short V3 observe the instructions within this chapter.

⚠ WARNING

Energy hazards-240 VA present inside the chassis!

Before removing the top cover. Switch off the product properly using the power switch on the front side and disconnecting the power cable from the mains power supply.

⚠ WARNING

Recommended intended used is closed and locked

Only when the cover is secured is it ensured that the operator does not have access to the internal parts, loaded with hazardous energy. To close properly secured using all knurled screws: one front side and three rear side.

7.1. Opening and Closing the Cover

To open the cover, perform the following:

1. Switch off and disconnect the product from the mains power supply.
2. Loosen the cover's one knurled screw on the front side (Figure 22) and the three knurled screws on the rear side (Figure 23).

Figure 22: Loosening knurled screw on the front side



Figure 23: Loosening knurled screws on the rear side



3. Pulling the cover out slightly as shown in Figure 24, releases the cover's centering and fixing brackets (Figure 19 pos.3 and pos. 4) from the retaining brackets of the chassis (Figure 20, pos. 1).

Figure 24: Pull and release the cover



4. Lift the cover up (on the rear edge) to remove the cover as shown in Figure 25.

Figure 25: Removing the cover



5. To close and secure the cover, proceed in the reverse order (step 4 to step 2).

⚠WARNING

To close properly secure using all knurled screws: one front side and three rear side.

7.2. Accessing Internal Components

This chapter contains important information on working safely with internal components. Follow these instructions when handling internal components and observe the corresponding safety instruction included in Chapter 1/: General Safety Instructions for IT Equipment.

⚠WARNING

Energy hazards-240 VA present inside the chassis!

Before removing the top cover. Switch off the product properly using the power switch on the front side and disconnecting the power cable from the mains power supply.

⚠WARNING

Activities requiring internal access of the product must be performed by trained personnel aware of the associated dangers!



ESD Sensitive Device!

Follow the safety instructions for components that are sensitive to electrostatic discharge (ESD). Failure to observe this warning notice can result in damage to the components.



Consult the documentation provided by the expansion card's manufacturer for instructions before installing/removing an expansion card.

7.2.1. Installing and Removing Riser Card Expansion Cards

The mainboard with riser card is mounted on a card cage. To access the slot bracket or expansion card screws, the card cage must be pulled-out slightly.

To install or remove a riser card expansion cards, proceed as follows:

1. Switch off and disconnect the product from the mains power supply.
2. Open the cover as described in Chapter 7.1: Opening and Closing the Cover.
3. Unscrew the four card cage screws on the rear side (Figure 26). Retain the screws for later use.
4. Lift the card cage upwards, and slide out slightly, to gain access to the slot bracket or expansion card screws.

Figure 26: Pulled-out card cage screws

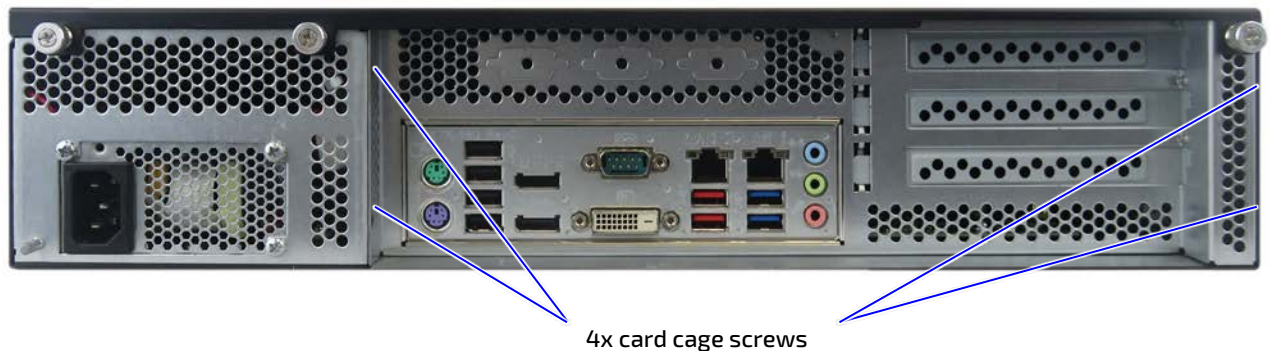

5. Install/remove the expansion card(/s) in/from the respective riser card's expansion slot(/s) (Figure 21, pos. 9) and fasten the expansion card or the slots bracket to the card cage.(Figure 21, pos. 8)
6. Slide the card cage back into the original position and fasten the four card cage screws to secure the card cage.
7. Close and secure the cover with the knurled screws.as described in Chapter 7.1: Opening and Closing the Cover (step 5).

7.2.2. Installing and Removing Low Profile Expansion Cards

To install or remove low profile expansion cards, proceed as follows:

1. Switch off and disconnect the product from the mains power supply.
2. Open the product as described in the Chapter 7.1: Opening and Closing the Cover.
3. Install a low profile expansion card by removing the slot bracket's fasten screw and retaining the slot bracket with screw for later use. Insert the low profile expansion card into the respective expansion card slot and secure the expansion card with fastening screw (Figure 20: pos. 6)
4. Remove a low profile expansion card by unscrewing the expansion card's screw (Figure 20, pos. 6).and removing the low profile expansion card from the respective expansion card slot on the mainboard. (Store the expansion card with screw for possible later use). Insert a slot bracket into the empty expansion card slot on the rear side of the chassis and secure the slot bracket by fastening the slot bracket screw. (Figure 20: pos. 6)
5. Close and secure the cover with the knurled screws as described in the Chapter 7.1: Opening and Closing the Cover (step 5).

8/ Installation

The KISS 2U Short V3 is designed for horizontal installation in a 19" industrial rack cabinet with the top cover facing upwards. There are no ventilation holes on the top and bottom side of the product, enabling installation directly on top of or below other systems in the 19" industrial rack cabinet. Due to possible access restrictions Kontron recommends installing all expansion cards and connecting all peripherals to the corresponding system ports before installing in the end environment.

Before installing or removing the KISS 2U Short V3 in a 19" industrial rack cabinet or desktop environment, read the installation instructions in this chapter and observe the information in Chapter 1/:General Safety Instruction for IT Equipment. Due to possible access restrictions, Kontron recommends installing all expansion cards and connecting all peripherals to the corresponding system ports before installing in the end environment.

⚠ WARNING

The product must be installed only by trained personnel aware of the associated dangers.

⚠ WARNING

Ensure Sufficient Airflow

Ensure the KISS 2U Short V3 is well ventilated and does not prevent the KISS 2U Short V3 from taking in air at the front and exhausting air at the rear.

⚠ WARNING

Do not place the product close to heat sources or damp places.

⚠ CAUTION

Before connecting any I/O cables, ensure that the product is switched off and the power cable is disconnected connected from the power connector or mains power.

⚠ CAUTION

When connecting cables, following proper cabling procedures:

1. Grounding pin is connected first and disconnected last
2. Connect all I/O cables
3. Power connection is the last connection



The KISS 2U Short V3 is design for horizontal operation. Vertical operation is possible.



Due to possible access restrictions, before installing the product install all expansion cards and connect required peripherals to the corresponding system port.

8.1. Installing the Rubber Feet

For use on a desktop, to avoid scratching the surface, attach the supplied four rubber feet:

1. Switch off and disconnect the product from the mains power supply. Disconnect all peripherals.
2. Ensure that all components are securely installed and that the cover is closed and secured.
3. Turn the chassis upside down (Orientation: bottom side facing upwards).
4. Remove the protective film from the self-adhesive rubber feet and attach to the bottom side of the chassis.
5. Turn the chassis the right way around (Orientation: cover facing upwards).

8.2. Removing the Handle Brackets and Front Access Panel Side-Plates

The two handles brackets are removable. To remove the handles brackets, proceed as follows:

1. Loosen and remove the two screw (Figure 8, pos. 5) that fasten the handles bracket and front access panel side-plates to the chassis (left side and right side).
2. Reattach the front access panel side-plates using the original two screws (left side, right side).
3. Store the two handle brackets for possible further use
4. To reinstall the handle brackets proceed in the reverse order (step 1 to 2).



The KISS 2U Short V3 is delivered with the handle brackets already assembled.

8.3. Removing the Front Access Panel and Front Access Panel Side-Plates

The front access panel and the two front access panel side-plates are removable.

Figure 27: Front access panel side-plate with handle bracket

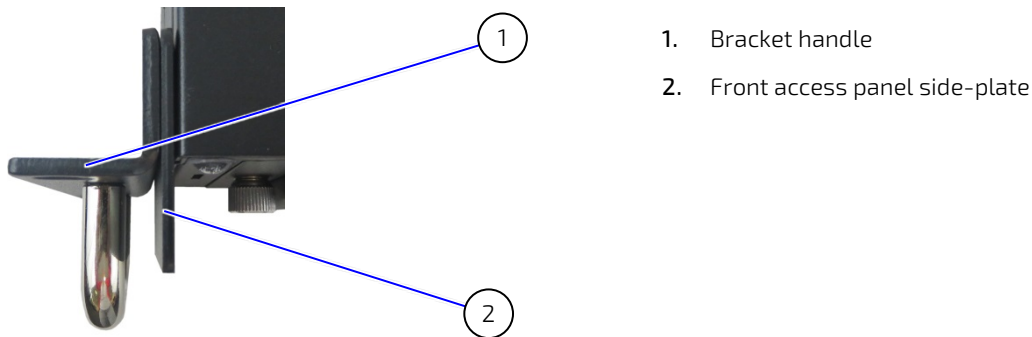

To remove the front access panel and front access panel side-plates, proceed as follows:

1. Loosen the fastening screws that fasten the handle bracket and front access panel side-plates to the chassis (left side and right side).
2. When loosen enough release the front access panel's hinge from the front access panel side-plate's hole. Initially release one side of the front access panel and the other side will loosen and can be removed.
3. Move the front access panel slightly to the left to remove the front access panel from the central hinge and then carefully guide the front access panel's holder arm out of the holding slot.
4. Store the front access panel for future use.
5. Remove the front panel side-plates (left side and right side) by removing the screws previously loosened in step 1.
6. If required re- attach the handle brackets (left side and right side), using the screws removed in step 5.

8.4. Installing as a Desktop

Before installing the KISS 2U Short V3 in a desktop environment, install the rubber feet as described in Chapter 8.1: Installing the Rubber Feet, to avoid scratching the installation surface. Additionally, observe the general instructions and any safety warnings within this chapter.

⚠ WARNING

The voltage feeds must not be overloaded.

Adjust the cabling and the external overcharge protection to correspond with the electrical data indicated on the type label located on right side of the chassis.

⚠ WARNING

Ensure Sufficient Air Flow

Ensure that nothing obstructs the KISS 2U Short V3 from taking in air at the front and exhausting air at the rear.

To install in a desktop environment, proceed as follows:

1. Add the rubber feet as described in Chapter 8.1: Installing the Rubber Feet.
2. Remove the handle brackets as described in Chapter 8.2: Removing the Handle Brackets
3. If required, remove front access panel and the two front access panel side-plates as described in Chapter 8.3: Removing the Front Access Panel and Front Access Panel Side-Plates.

8.5. Installing in a 19" Industrial Rack

Before installing the KISS 2U Short V3 in a 19" industrial rack, observe the instructions in this chapter and any additional safety warnings. To assemble the slide rails for a 19" industrial rack, see Chapter 8.6: Installing Slide Rails (Option).

⚠ WARNING

Install only in a stable 19" industrial rack cabinet. To improve stability:

- ▶ Placing system from the bottom up
- ▶ Place heavy systems lower down
- ▶ Bolt the cabinet to the floor or anchor the cabinet to the wall

⚠ WARNING

To support the KISS 2U Short V3's weight, two separate fixation methods must be used:

- ▶ Front handle brackets (left side, right side)
- ▶ Slide rails or L brackets or a 19" rack rear/side fixation

⚠ WARNING

Ensure Sufficient Airflow

Ensure that the 19" Industrial rack cabinet is well ventilated and does not prevent the KISS 2U Short V3 from taking in air at the front and exhausting air at the rear.

⚠ CAUTION

Installing the KISS 2U Short V3 alone can result in product damage or personal injury.

⚠ CAUTION

Verify secure mounting
Mount using the slides rails on the left and right sides and ensure the front handle brackets are fastened to the left and right sides of the 19" Industrial rack cabinet.



Due to possible access restrictions, before installing the KISS 2U Short V3 install all expansion card and connect required peripherals to the corresponding system ports.

To install in a 19" industrial rack, proceed as follows:

1. Install the slide rails to the KISS 2U Short V3 as described in Chapter 8.6: Installing Slide Rails (Option).
2. Install the corresponding slide kits to the 19" industrial rack cabinet.
3. Push the KISS 2U Short V3 with slide rail assembly as far as possible into the corresponding installed rack slide rail.
4. Firmly attach the handle brackets to the sides of the 19" industrial rack cabinet.
5. Verify that the KISS 2U Short V3 is securely mounted.

8.6. Installing Slide Rails (Option)

Kontron offers compatible 19" Slide Rails and Rack Slide Rails Kit for the KISS 2U Short V3. For more information, see Table 2: Accessories and spares parts.

⚠ WARNING

To support the KISS 2U Short V3's weight, two separate fixation methods must be used:

- ▶ Front handle brackets (left side, right side)
- ▶ Slide rails or L brackets or a 19" Industrial rack rear side fixation

⚠ CAUTION

Use only the specified screws only to attach telescope slide rails to the KISS 2U Short V3.

⚠ CAUTION

Verify secure mounting
Mount using the slides rails on the left and right sides and ensure the front handle brackets are fastened to the left and right sides of the 19" Industrial rack cabinet.

To install slide rails, proceed as follows:

1. Extend the slide rail to the pulled-out position to expose the inner part of the slide rail (Figure 29) with screw holes. (Figure 28, pos. 2).
2. Using the supplied screws firmly attach the side rail to the left side and right side (Figure 28, pos. 2).
3. Push the slide rail into the pushed-in position (Figure 30).
4. Install the corresponding rack slide rail kits to the 19" industrial rack cabinet, see Figure 31: Assembling the slide rails in an industrial rack cabinet.

Figure 28: Slide rail inner part fastened to chassis

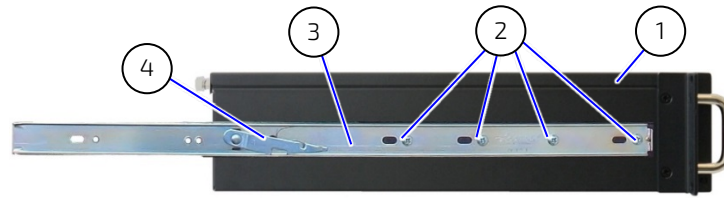

Figure 29: Slide rail in pulled-out position

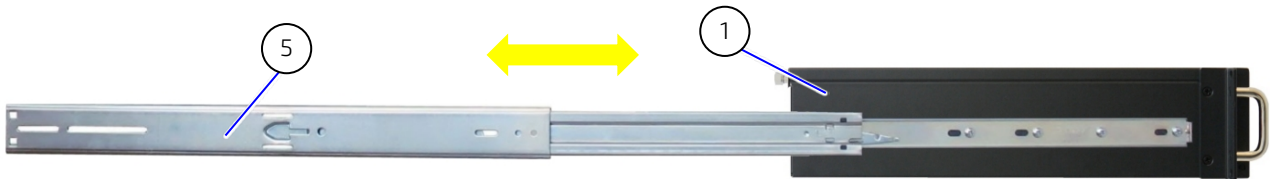

Figure 30: Slide rail in pushed-in position



Legend for Figure 28, Figure 29 and Figure 30

- | | |
|---|--------------------------------------|
| 1. Side view of the KISS 2U Short V3 | 4. Locking/unlocking lever |
| 2. Screws attaching slide rail to the chassis | 5. Slide rail in pulled-out position |
| 3. Inner part of the slide rail | 6. Slide rail in pushed-in position |

Figure 31: Assembling the slide rails in an industrial rack cabinet

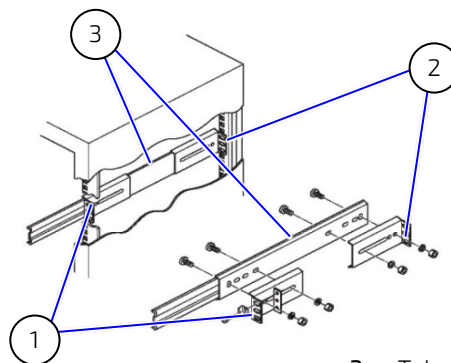

- | | |
|------------------------|--|
| 1. Short front bracket | 3. Telescopic slide rail attached to Industrial rack cabinet |
| 2. Long rear bracket | |



Short brackets are usually used at the front of the chassis and long brackets at the rear.

9/ Starting Up

Before starting up observe the instructions in Chapter 1: General Safety Instruction for IT Equipment and read the instructions and warnings in this chapter.

⚠ WARNING

Easy Access to Power Cable and Power Connectors

The power cable must always remain easily accessible. If the end environment restricts access to power cable, disconnection must be guaranteed using a separate cut-off fixture.

⚠ WARNING

Energy hazards-240 VA present in the chassis

To switch off the product properly and ensure no energized internal parts, switch off the product using the power switch on the front side and disconnecting the product's power cable from the input power socket or the mains power supply.

⚠ WARNING

Intended used is closed

Use only when the cover is closed using the kurnled screws (one front side and three rear side) to ensured that the operator doesn't have access to energized internal parts.

⚠ CAUTION

Ensure that the mains power supply socket (power outlet) is properly grounded and the power cable is in perfect condition with no visible damage.

⚠ CAUTION

The rated mains voltage range must agree with the voltage specified on the type label.

9.1. Connecting the Power Connection

The input power socket is located on the rear side. To connect the power and start up, proceed as follows:

1. Connect the ends of the supplied AC power cable to the corresponding sockets:
 - a. Input power socket (Figure 32)
 - b. Mains power supply socket using the electrical plug for the region.

Figure 32: Input power socket



2. Unlock the front access panel (Figure 7, pos. 3) and press the power button (Figure 9, pos. 7).
3. Close and lock the front access panel.
4. The power LED illuminates green. (Figure 7, pos. 2 and Figure 11, pos. 1)

NOTICE

Do not disconnect the power from the product while the product is powered up!
Performing a forced shut down can lead to loss of data or other undesirable effects!

9.2. Operating System and Hardware Component Drivers

The KISS 2U Short V3 is operational when switched on for the first time with pre-installed Operating System (OS) Windows 10 IOT 64-bit or Linux and with all required drivers. Drivers are available from Kontron's EMD customer section.

If ordered without pre-installed OS, before starting the KISS 2U Short V3 install the OS and the appropriate drivers for the system configuration. Consider the manufacturer's specifications for the OS and the integrated hardware components.



Download relevant drivers for the installed hardware by visiting Kontron's EMD Customer Section: <https://www.kontron.com/support-and-services/support/customer-section>.



Pay attention to the installed hardware components manufacturer's OS specification.

10/ Maintenance and Prevention

Kontron systems only require minimal maintenance and care to maintain correct operation.

- ▶ Wipe the product with a soft dry cloth if required
- ▶ Remove persistent dirt using a soft, slightly damp cloth (only use a mild detergent).
- ▶ Clean the air filter pad regularly (as often as necessary, depending on the environment)

10.1. Cleaning the Filter Pad

The filter pad inserts into the filter pad holder at the front side of the fan assembly. The filter pad is soiled by pollution within the operating environment. If heavily soiled the filter pad can cause excessive heating of the product. Kontron recommends cleaning the filter pad as often as necessary. It is possible to change the filter pad during the operation of the product.

Figure 33: Front side with filter pad holder

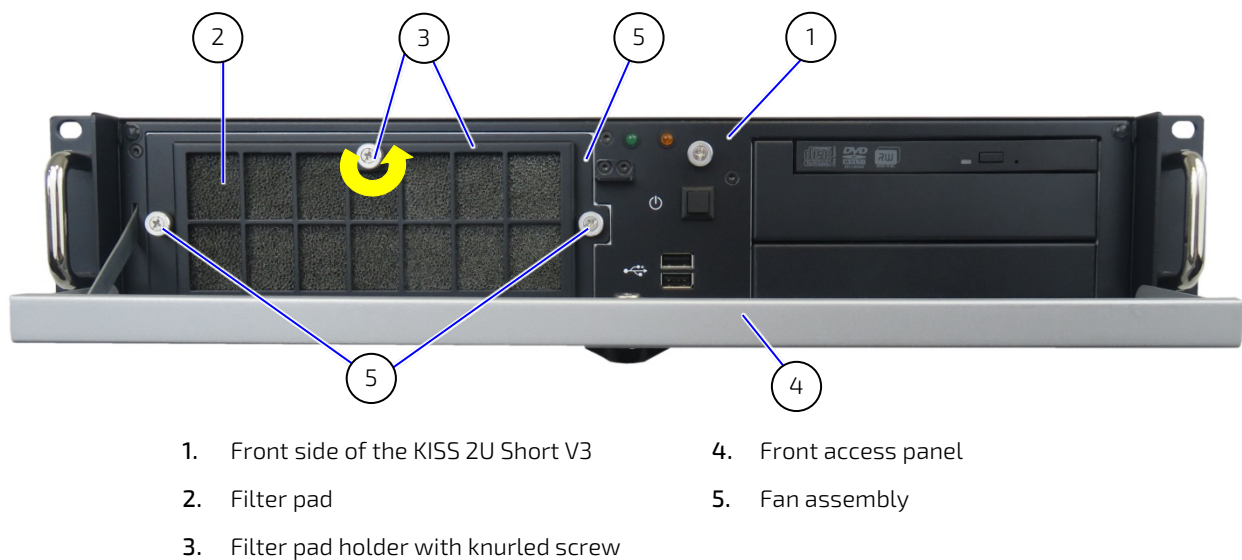

- | | |
|---|-----------------------|
| 1. Front side of the KISS 2U Short V3 | 4. Front access panel |
| 2. Filter pad | 5. Fan assembly |
| 3. Filter pad holder with knurled screw | |

CAUTION

Operation is permitted only with a functional fan assembly!
Replace a defective fan assembly only with an original fan assembly.

To replace the filter pad, proceed as follows:

1. Open the front access panel, (Figure 33 pos. 4).
2. Loosen the knurled screw (Figure 33, pos. 3) that secures the filter pad holder to the fan assembly in the direction shown.
3. Release the filter pad holder's positioning latches from the positioning holes on the fan assembly (Figure 34, pos. 3) by moving upwards and lifting out the filter pad holder.
4. Remove the dirty filter pad (Figure 37), from the filter pad holder.
5. Clean the filter pad as follows:
 - a. Rinse the filter pad in water (up to approx. 40°C/104°F; with a mild commercial detergent).
 - b. It is also possible to beat the filter pad, suction clean the filter pad, or blast the filter pad with warm compressed air.
 - c. If the filter pad is soiled with grease and dust, rinse the filter pad in warm water with a degreaser.
 - d. Do not clean the filter pad with a piercing jet of water.

6. Do not wring out the filter pad, allow the filter pad to air dry.
7. After cleaning and drying the filter pad, place the filter pad in the filter pad holder (Figure 36).
8. Reattach the filter pad holder to the front side of the fan assembly by inserting the filter pad holder's positioning latches (Figure 35, pos. 7) into the fan assembly's positioning holes (Figure 34, pos. 3).
9. Fasten the filter pad holder by tightening the knurled screw (Figure 35, pos. 6) to the bolt with tapped hole (Figure 34, pos. 1) on the fan assembly.

Figure 34: Front side without filter pad

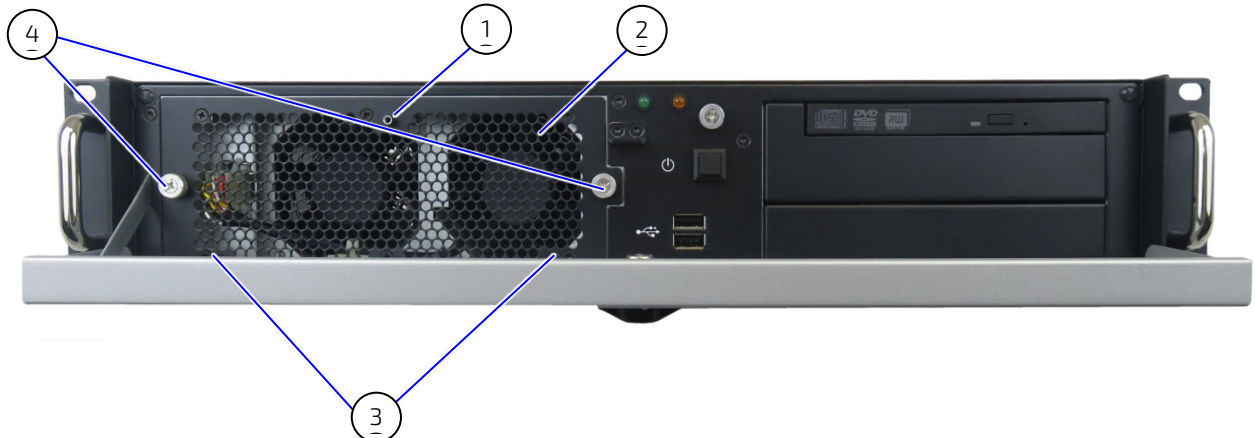

Figure 35: Filter pad holder (without filter pad)

Figure 36: Filter pad holder (with filter pad)

Figure 37: Filter pad



- | | |
|---|---|
| <ol style="list-style-type: none"> 1. Fan assembly with bolt with tapped hole 2. Ventilation holes for air intake on the front side of the fan assembly 3. Positioning holes for the filter pad holder | <ol style="list-style-type: none"> 4. Knurled screw to fix fan assemble in the chassis 5. Filter pad holder 6. Knurled screw of the filter pad holder 7. Positioning latches of the filter pad holder |
|---|---|

10.2. Replacing the Fan Assembly

Before replacing the fan assembly, read the following instructions:

⚠ CAUTION

Operation is permitted only with a functional fan assembly!
Replace a defective fan assemble only with an original fan assembly.

⚠ CAUTION

Fan assembly replaceable during operation
Replace fan only by qualified personnel or a suitably instructed persons aware of the associated dangers. Before removing the fan assembly, wait until the fans have totally stopped. Keep hands and fingers away from rotating fan parts.



The filter pad holder can be fasten to the front side of the fan assembly either before or after the fan assembly is installed in the chassis.

To replace the fan assembly, proceed as follows:

1. Remove the filter pad holder as described in the Chapter 10.1 Cleaning the Filter Pad (step 1 to 3) and retain the filter pad holder with filter pad for later use.
2. Loosen the two knurled screws on the fan assembly (Figure 38, pos. 2)
3. Pull out the fan assembly to disconnect the fan assembly from the internal fan control socket (Figure 39, pos. 1).
4. Lift the fan assembly upwards as shown (Figure 38) to remove from the fan compartment (Figure 39, pos. 2).

Figure 38: Removing the fan assembly

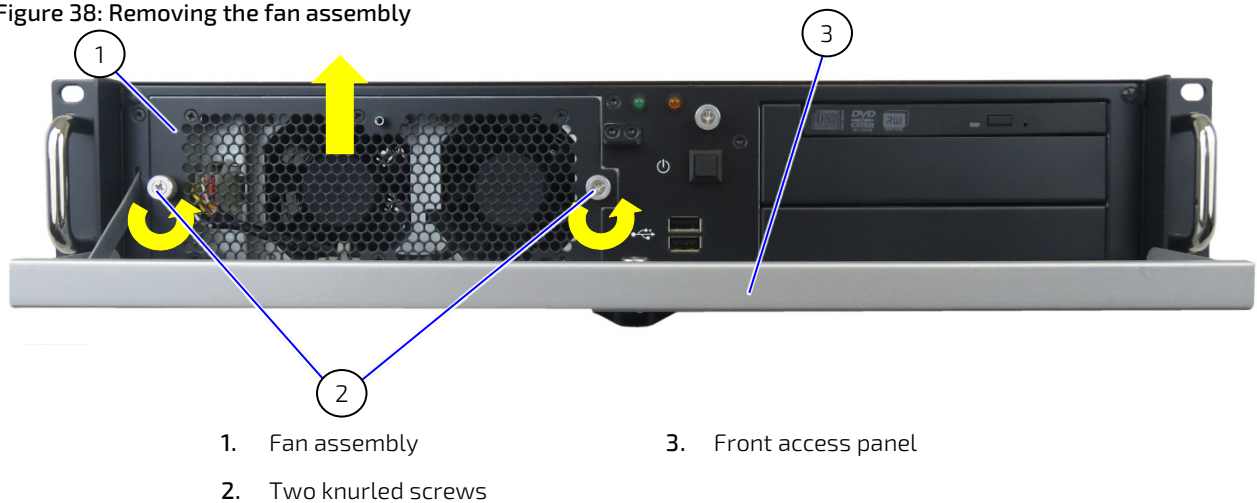

Figure 39: Fan compartment without fan assembly



1. Fan power control socket 2. Fan compartment

5. To replace with a new functional fan assembly, align the fan assembly with the fan compartment.
6. Push the fan assembly carefully into the fan compartment until the fan assembly's control connector (Figure 12, pos2) is firmly inserted into the internal fan power control socket (Figure 39, pos. 1).
7. Secure by fasten the knurled screws of the fan assembly (Figure 38, pos. 2)
8. Insert the filter pad into the filter pad holder (both retained in step 1). Then reattach the filter pad holder to the front side of the fan assembly as described in the Chapter 10.1: Cleaning the Filter Pad (steps 7 to 9).

10.3. Replacing the Lithium Battery

⚠ CAUTION

CAUTION: Risk of Explosion if the lithium battery is replaced by an incorrect type. Dispose of used lithium batteries according to the Instructions.

ATTENTION: Risque d'explosion si la pile au lithium est remplacée par une pile de type incorrect. Éliminez les piles au lithium usagées conformément aux instructions.



Do not dispose of lithium batteries in general trash collection. Dispose of the battery according to the local regulations dealing with the disposal of these special materials, (e.g. collecting points for dispose of batteries).

To replace the lithium battery on the mainboard, proceed as follows:

1. Switch off and disconnect the product from the mains power supply.
2. Open the cover, as described in the Chapter 7.1: Opening and Closing the Cover (steps 1-4).
3. If the product includes expansion cards, first remove the expansion cards and all corresponding connecting cables, to gain access to the lithium battery, see Chapter 7.2: Accessing Internal Components.
4. Remove the lithium battery from the holder by pulling the ejector spring outwards.
5. Place a new lithium battery in the battery holder.
6. Pay attention to the polarity of the battery.
7. Replace the lithium battery only with the same type of battery or with a type of battery recommended by Kontron.
8. Reinstall the removed expansion cards and reattach the connecting cables.
9. Close the cover, as described in the Chapter 7.1: Opening and Closing the Cover (step 5).

11/Technical Data

This chapter lists the main KISS 2U Short V3 technical specifications.

11.1. Block Diagrams

Figure 40: Block diagram KISS 2U Short V3 CFL Low Profile

KISS 2U Short V3 CFL Low Profile

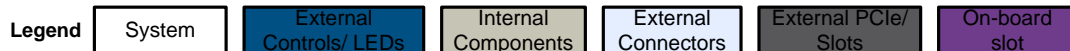
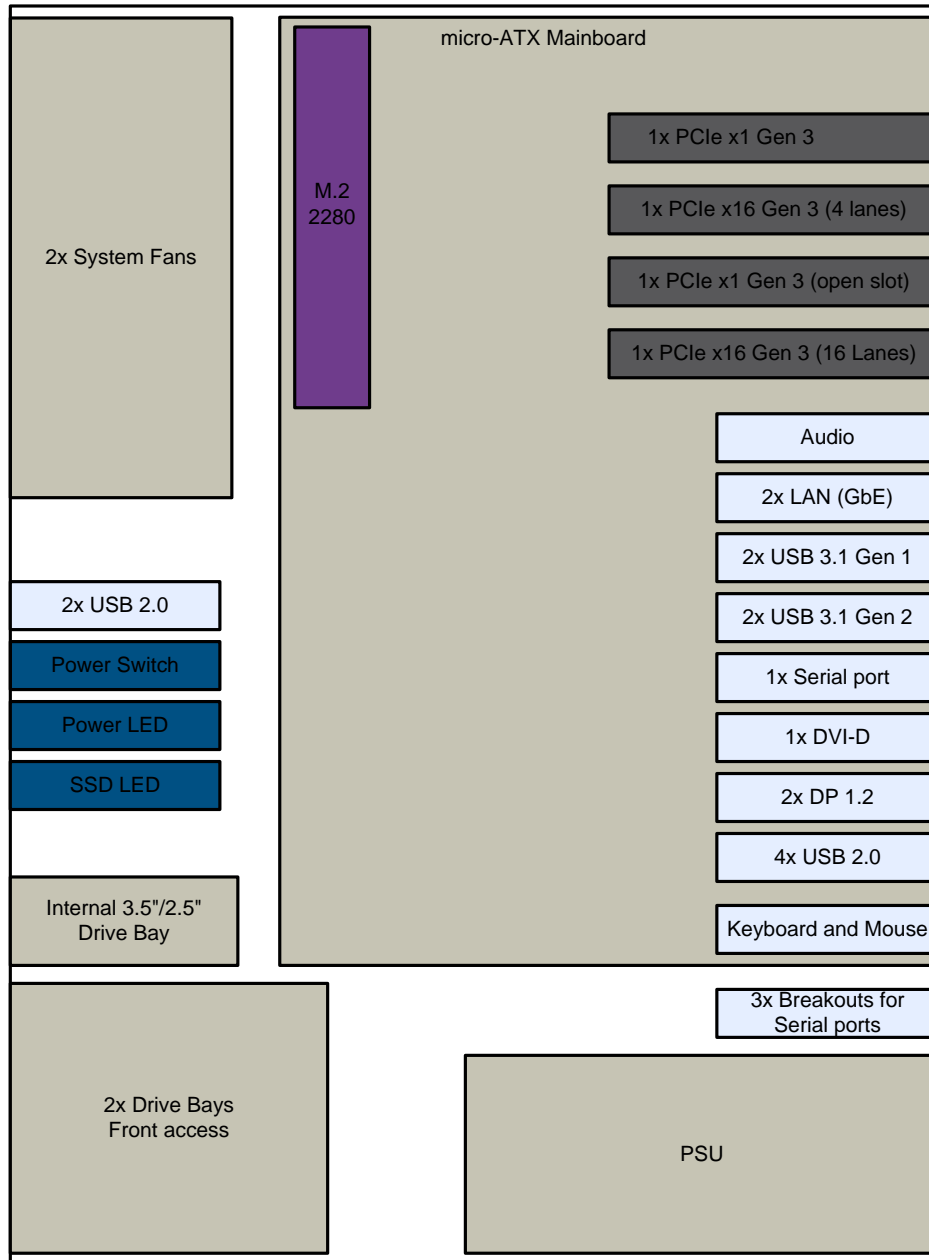
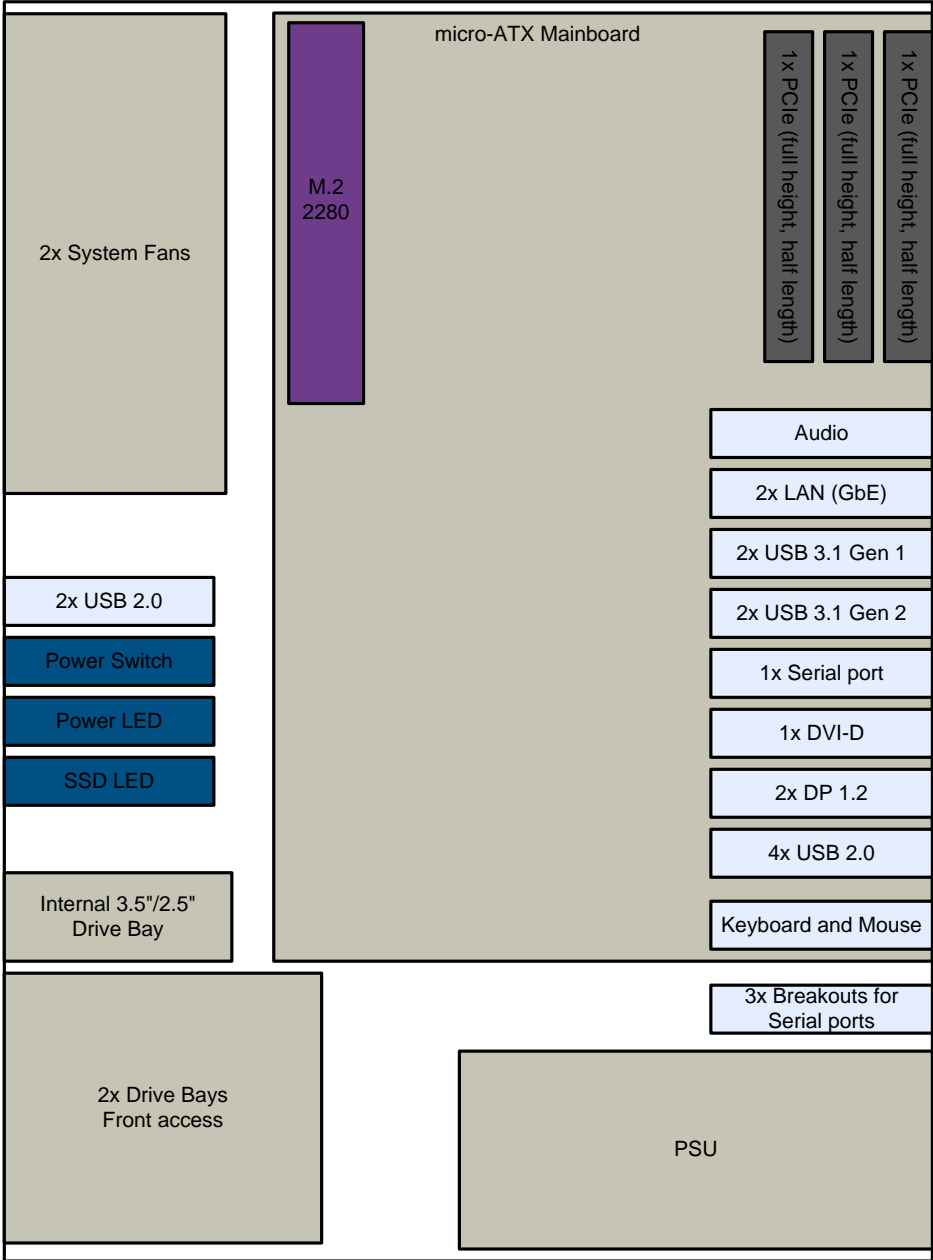

Figure 41: Block diagram KISS 2U Short V3 CFL Riser Card

KISS 2U Short V3 CFL Riser Card



Legend

System	External Controls/LEDs	Internal Components	External Connectors	External PCIe/Slots	On-board slot
--------	------------------------	---------------------	---------------------	---------------------	---------------

11.2. Technical Specification

KISS 2U Short V3 CFL		
Board		
Mainboard	D3641-S (micro-ATX)	
Processor Type	Intel® Core™ i7, i5, i3 series 7 th /8 th /9 th Gen Or Intel® Xeon® E-21XX series	
Chipset	Intel® C246 Express	
Memory	4x DDR4 2666 UDIMM/ ECC support only with Xeon E Max. 64 GB (With 2x 4 GB, 2x 8 GB, 2x 16 GB, 4 x 16 GB)	
Front I/O		
USB	2x USB 2.0	
Drive bays		
Front Accessible	1x slim drive bay	for slim DVD drives
	1x 3.5" drive bay	for 2.5" drives
Internal	1x 3.5" drive bay	for 3.5" or 2.5" drives
Mass Storage Options		
Mass Storage Device	1x M.2 2280 (PCIe 4 lanes)	
Rear I/O		
USB	4x USB 2.0 2x USB 3.1 Gen1 2x USB 3.1 Gen2	
LAN	2x 1 Gb (1x i219LM & 1x i210AT) ▶ 10/100/1000 Mbit/s ▶ ATM 12.0 /vPro support ▶ Teaming support	
Display	1x DVI-D (1920 x 1200 @60 Hz) 2x Display Port V 1.2 (4096x2304 @60Hz)	
PS/2	Keyboard, Mouse	
Audio	1x Line in, 1x Line out 1x Microphone	
Serial Port	1x RS232	
	(Two optional additional serial ports cutouts on the rear side of the chassis)	
Expansion Slots		
Type	Low profile cards	Riser cards
Slots	4x PCIe slots (Low profile)	3x PCIe slots (full height, half length)
Mass Storage Options		
	1x M.2 2280 (PCIe 4 lanes)	
Fans		
System Fan (external)	2x fans included in removable fan assembly	
Internal Fans	1xPSU (integrated in PSU) 1xCPU (heatsink with fan)	

KISS 2U Short V3 CFL	
Software	
Operating System	MS Windows 10 IoT x64 Linux
BIOS	AMI UEFI BIOS 5.x ^[1]

^[1] Only UEFI BIOS is supported.



UEFI only! No legacy support and no Master Boot Record (MBR) installation.

11.3. Power Specification

KISS 2U Short V3 CFL	
Power	
PSU Type	Industrial AC/DC 1HE
Output Power	400 W
Input Voltage Range	240 VAC to 100 VAC (50Hz to 60 Hz) ^[1]
Input Current	6 A Max.

^[1] The electrical specification is available on the type label. For more information, see Chapter 3.3: Type Label.

11.4. Mechanical Specification

Dimension	KISS 2U Short V3 (with front access panel)	KISS 2U Short V3 (without front access panel)
Height	88 mm (3.46")	88 mm (3.46")
Width	482 mm (19")	430 mm (16.93")
Depth	368 mm (14.49")	350 mm (13.78")
Weight	7 kg (approx.)	
Chassis	Chassis: RAL 7021 Front panel: RAL 9022 – standard Front panel: RAL 5017 – option	



For detailed mechanical dimensions, visit Kontron's EMD Customer Section at:
<https://www.kontron.com/support-and-services/support/customer-section>

11.5. Environmental Specification

Temperature		Description
Temperature	Operating	0 °C to +50 °C (+50°F to +122 °F)
	Storage & Transit	-20°C to +70°C (-4°F to +158°F)
Relative Humidity	Operating and Storage & Transit	10-93 % @ 40° C, non condensing
Environment		Description
Altitude	Operating	5,000 m (16,400 ft.) Max.
	Storage & Transit	10,000 m (32,810 ft.) Max.
Shock	Operating	15 g, 11 ms, duration
	Storage & Transit	30 g., 11 ms, duration
Vibration	Operating	10 Hz – 150 Hz, 1.0 g, 3 axis
	Storage & Transit	10 Hz – 150 Hz, 2.0 g, 3 axis
MTBF		50,000h @ 30°C (min. configuration)

11.6. CE Directives and Standards

The KISS 2U Short V3 complies with the European Council Directive and the approximation of the laws of the member states. If modified, the prerequisites for specific approvals may no longer apply.

Kontron is not responsible for any radio television interference caused by unauthorized modifications of the product or the substitution or attachment of connecting cables and equipment other than those specified by Kontron. The correction of interference caused by such unauthorized modification, substitution or attachment will be the responsibility of the operator.

CE		
CE Marking	Council Directive	93/68/EEC
Safety	General Product Safety Directive (GPSD)	2001/95/EC
	Low Voltage Directive (LVD)	2014/35/EU
Electromagnetic Compatibility	Electromagnetic Compatibility Directive (EMC)	2014/30/EU
EMC		
Emission (Class B)	EN 55032/ CISPR 32	Electromagnetic compatibility of multimedia equipment- Emission requirements
	EN 61000-6-3	Emission standard for residential, commercial and light-industrial environments
Immunity (Industrial Equipment)	EN 55024 / CISPR 24	Information technology equipment- Immunity characteristics
	EN6100-6-2	Immunity for industrial environments
Safety		
Europe	EN 62368-1	Audio/video, information and communication technology equipment – Safety requirements
CB Scheme	CB Report - IEC 62368-1	
Environment		
WEEE	Compliant with the Waste Electrical and Electronic Equipment (WEEE) 2012/19/EU directive; to reduce waste of electrical and electronic equipment, encourage recycling and environmental disposal and increase the environmental awareness of producers	
Environment		

RoHS II	Compliant with the Restriction of Hazardous Substances (RoHS) 2011/65/EU directive or the latest status thereof, to reduce hazardous substances in electrical and electronic equipment
REACH	Compliant with the Registration, Evaluation, Authorization and Restriction of Chemicals (REACH) Regulation No. 1907/2006 to identify the intrinsic properties of chemical substances earlier

12/ Standard Interfaces- Pin Assignments

12.1. Keyboard Connector Pin Assignment

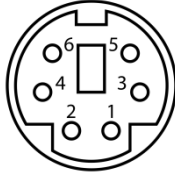
Pin	Signal Name	Keyboard Connector
1	Data	
2	NC	
3	GND	
4	+5V ^[1]	
5	Clock	
6	Keyboard_On ^[2]	

^[1] fuse protected

^[2] low asserted pulse

12.2. PS/2 Mouse Connector Pin Assignment

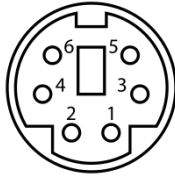
Pin	Signal Name	PS/2 Connector
1	Data	
2	NC	
3	GND	
4	+5V ^[1]	
5	Clock	
6	Keyboard_On ^[2]	

^[1] fuse protected

^[2] low asserted pulse

12.3. USB 2.0 Port Pin Assignment

Pin	Signal Name	USB 2.0 Connector
1	+5V ^[1]	
2	Data-	
3	Data+	
4	GND	

^[1] fuse protected

12.4. Display Port Pin Assignment

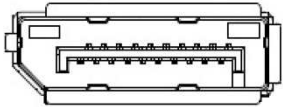
Pin	Signal Name	Pin	Signal Name	DP (V1.2) Connector
1	TX0+	11	GND	
2	GND	12	TX3-	
3	TX0-	13	DVI dongle detect/ GND	
4	TX1+	14	GND / CEC for HDMI	
5	GND	15	AUX+	
6	TX1-	16	GND	
7	TX2+	17	AUX-	
8	GND	18	Hotplug detect	
9	TX2-	19	GND	
10	TX3+	20	+3.3 V ^[1]	

^[1] fuse protected

12.5. COM 1 Connector Pin Assignment

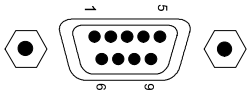
Pin	RS232	RS422	RS 485 Half Duplex	RS 485 Full Duplex	COM Connector
1	DCD	Tx-	Data-	Tx-	
2	RxD	Tx+	Data+	Tx+	
3	TxD	Rx+		Rx+	
4	DTR	Rx-		Rx-	
5	GND	GND	GND	GND	
6	DSR				
7	RTS				
8	CTS				
9	RI				

12.6. DVI-D Connector Pin Assignment

DVI-D Dual-link socket supports single-link only.

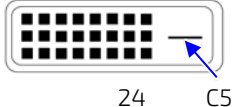
Pin	Signal Name	Pin	Signal Name	Pin	Signal Name	DVI-D Connector	
1	Data2-	9	Data1-	17	Data0-		
2	Data2+	10	Data1+	18	Data0+		
3	GND	11	GND	19	GND		
4	NC	12	NC	20	NC		
5	NC	13	NC	21	NC		
6	DDC Clock	14	+5 V ^[1]	22	GND		
7	DDC Data	15	GND	23	Clk +		
8	NC	16	Hot Plug Detect	24	Clk -		
						C5	GND

^[1] fuse protected

12.7. LAN Connector Pin Assignment

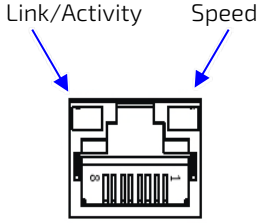
Pin	Signal Name (10/100/1000)	Pin	Signal Name (10/100)	RJ45 (female) Connector
1	MX1+	1	TX+	
2	MX1-	2	TX-	
3	MX2+	3	RX+	
4	MX3+	4	NC	
5	MX3-	5	NC	
6	MX2-	6	RX-	
7	MX4+	7	NC	
8	MX4-	8	NC	

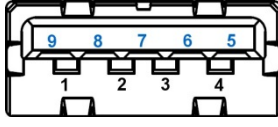

12.8. USB 3.0 and USB 3.1 (Gen1/Gen2) Port Pin Assignment

Pin	Signal Name	Pin	Signal Name	USB 3.0/3.1 Type A Connector[2]
1	+5V ^[1]	5	USB3_RX-	
2	USB2_D-	6	USB3_RX+	
3	USB2_D+	7	GND	
4	GND	8	USB3_TX-	
		9	USB3_TX+	

^[1] fuse protected

^[2] USB 3.1 connectors provide separate signal lines for USB 3.0/3.1 and USB 2.0.

12.9. Audio Jack Pin Assignment

Jack	Signal	Audio Barrel Jack
A	Line-in	
B	Line-out	
C	Microphone-in	

13/ Technical Support

In order to request technical support, send an email with the information below to support@kontron.com

- ▶ Product name
- ▶ Product model number
- ▶ Serial number of the unit
- ▶ Brief problem description
- ▶ Complete company address

Customers with service portal access may maintain their tickets directly in the service portal.



The serial number can be found on the product's type label

13.1. Returning Defective Merchandise

All equipment returned to Kontron must have a Return of Material Authorization (RMA) number assigned exclusively by Kontron. Kontron cannot be held responsible for any loss or damage caused to the equipment received without an RMA number. The buyer accepts responsibility for all freight charges for the return of goods to Kontron's designated facility. Kontron will pay the return freight charges back to the buyer's location in the event that the equipment is repaired or replaced within the stipulated warranty period.

Follow these steps before returning any product to Kontron.

1. Visit the RMA Information website:



Kontron's RMA Information website can be found at:

<http://www.kontron.com/support-and-services/support/rma-information>

2. Download the RMA Request sheet for Kontron Europe GmbH, Augsburg and fill out the form. Take care to include a short detailed description of the observed problem or failure and to include the product identification (product name, material number and serial-number). If more than one product is sent in a delivery. Fill out the above information in the RMA Request form for each product.
3. Send the completed RMA-sheet to the given fax or email address at Kontron Europe GmbH. Kontron Europe GmbH will provide an RMA-Number within one business day.
4. The goods for repair shall be packed properly for shipping, considering shock and ESD protection.



Goods returned to Kontron Europe GmbH in non-proper packaging are considered as customer caused faults and cannot be accepted as warranty repairs.

5. Add the RMA-sheet to the relevant delivery address and include the RMA-No with the shipping paperwork.

Sent the product to the following delivery address:

Kontron Europe GmbH
RMA Support
Lise-Meitner-Str. 3-5
86156 Augsburg
Germany

Phone: +49 (0) 821 4086-0
Fax: +49 (0) 821 4086 111
Email: service@kontron.com

6. After Kontron Europe GmbH receives the product, a confirmation of the order is sent via email to the address named on the RMA sheet.

14/ Storage and Transportation

14.1. Storage

If the product is not in use for an extended period time, disconnect the power plug from the mains power source .If it is necessary to store the product then re-pack the product as originally delivered to avoid damage. The storage facility must meet the products environmental storage requirements as stated within this user guide. Kontron recommends keeping the original packaging material for future storage or warranty shipments.

14.2. Transportation

To ship the product, use the original packaging, designed to withstand impact and adequately protect the product. When packing or unpacking products always take shock and ESD protection into consideration and use an EOS/ESD safe working area.

15/ Warranty

Kontron defines product warranty in accordance with regional warranty definitions. Claims are at Kontron's discretion and limited to the defect being of a material nature. To find out more about the warranty conditions and the defined warranty period for your region, following the steps below:

1. Visit Kontron's Term and Conditions webpage.
<http://www.kontron.com/terms-and-conditions>
2. Click on your region's General Terms and Conditions of Sale.

15.1. Limitation/Exemption from Warranty Obligation

In general, Kontron shall not be required to honor the warranty, even during the warranty period, and shall be exempted from the statutory accident liability obligations in the event of damage caused to the product due to failure to observe the following:

- ▶ General safety instructions for IT equipment within this user guide
- ▶ Warning labels on the product and warning symbols within this user guide
- ▶ Information and hints within this user guide

Additionally, alterations or modifications to the product that are not explicitly approved by Kontron, described in this user guide, or received from Kontron Support as a special handling instruction will void your warranty.

Due to their limited service life, parts that by their nature are subject to a particularly high degree of wear (wearing parts) are excluded from the warranty beyond that provided by law.

16/ Disposal

Final disposal of this product after the product's service life must be accomplished in accordance with the applicable country, state, or local laws or regulations.



Kontron manufactures products to satisfy environmental protection requirements where possible. Many of the components used are capable of being recycled.

Kontron follows the Waste Electrical and Electronic Equipment (WEEE) Directive that aims to reduce waste arising from Electrical and Electronic waste and therefore encourages customers to return Kontron products for proper disposal. For more information regarding WEEE compliance, refer to the Disposal and Recycling section at the start of this user guide.

List of Acronyms

Table 7: List of Acronyms

ATX	Advanced Technology eXtended
AMT	Active Management Technology
API	Application Program Interface
BIOS	Basic Input Output System
CLI	Command-Line Interface
COM	Communication port
CPU	Central Processing Unit
DC	Direct Current
DDR	Double Data Rate
DIMM	Dual Inline Memory Module
DP	Display port
DVD	Digital Video Device
DVI	Digital Video Interface
ECC	Error Checking and Correction
EMC	Electromagnetic Compatibility
ESD	ElectroStatic Discharge
GbE	Giga bit Ethernet
GPSD	General Product Safety Directive
GPU	Graphics Processing Unit
HD/HDD	Hard Disk /Drive
HPM	PICMG Hardware Platform Management specification family
iAMT	Intel® Active Management Technology
IOL	IPMI-Over-LAN
IOT	Internet of Things
IPMI	Intelligent Platform Management Interface
KCS	Keyboard Controller Style
KBD	Keyboard
KVM	Keyboard Video Mouse
LAN	Local Area Network
LED	Light-Emitting Diode
LVD	Low Voltage Directive
micro-ATX	Micro Advanced Technology eXtended

MEI	Management Engine Interface
NCSI	Network Communications Services Interface
OS	Operating System
PCB	Plastic Circuit Board
PCI	Peripheral Component Interconnect
PCIe	PCI-Express
PECI	Platform Environment Control Interface
PICMG®	PCI Industrial Computer Manufacturers Group
PSU	Power Supply Unit
RAM	Random Access memory
RDIMM	Registered DIMM
REACH	Registration, Evaluation, Authorization and restriction of Chemicals
RMA	Return of Material Authorization
RTC	Real Time Clock
SBC	Single Board Computer
SEL	System Event Log
ShMC	Shelf Management Controller
SMBus	System Management Bus
SMWI	System Monitor Web Interface
SOL	Serial Over LAN
SRAM	Synchronous Dynamic Random Access Memory
SSD	Solid State Drive
SSH	Secure Shell
TPM	Trusted Platform Module
UDIMM	Unregisterd DIMM
UEFI	Unified Extensible Firmware Interface
USB	Universal Serial Bus
WEEE	Waste Electrical and Electronic Equipment



About Kontron

Kontron is a global leader in IoT/Embedded Computing Technology (ECT). Kontron offers individual solutions in the areas of Internet of Things (IoT) and Industry 4.0 through a combined portfolio of hardware, software and services. With its standard and customized products based on highly reliable state-of-the-art technologies, Kontron provides secure and innovative applications for a wide variety of industries. As a result, customers benefit from accelerated time-to-market, lower total cost of ownership, extended product lifecycles and the best fully integrated applications.

For more information, please visit: www.kontron.com



Global Headquarters

Kontron Europe GmbH

Gutenbergstraße 2
85737 Ismaning
Germany
www.kontron.com